



TABLE OF CONTENTS

S. No.		Page No.
01	<i>Diagnostic / Preparation Instruments</i>	01
02	<i>Scalpel Holders, Amputation Knives & Saws</i>	09
03	<i>General Operating Scissors / T.C. Scissors</i>	16
04	<i>Dressing & Tissue Forceps / T.C. Forceps</i>	33
05	<i>Haemostatic Forceps</i>	40
06	<i>Needle Holders / T.C. Needle Holders</i>	56
07	<i>Retractors</i>	73
08	<i>Cardiovascular & Thoracic Instruments</i>	88
09	<i>Orthopaedics</i>	99
10	<i>Neurosurgery Instruments</i>	124
11	<i>Ophthalmology Instruments</i>	130
12	<i>Ear, Nose, Throat Surgery (ENT Surgery)</i>	133
13	<i>Intestinal, Rectal Instruments & Urology</i>	149
14	<i>Gynecology / Obstetrics Instruments</i>	159
15	<i>Hollow Wares</i>	175

DIAGNOSTIC SETS & CATHETER INTRODUCING FORCEPS

Diagnostik-bestecke, Kathetereinführzangen
Diagnostic Sets, Pinzas para catéteres

Estuches de diagnostico, Pinces pour introduire les sondes
Combinazioni per diagnostica, Pinze per introdurre le sonde



**DIAGNOSTIC SET
(ENT COMPLETE)
01-100**

Consisting of Battery Handle (without Battery)
3 Ear Specula, 1 Nasel Specula,
2 Laryngeal Mirrors with Holder
1 Tongue Depressor Holder, 1 Bulb



**OTOSCOPE SET
01-110**

Consisting of Battery Handle
(without Battery)
3 Ear Specula, 1 Nasel Specula,



**MAGILL
01-130
17 cm, 6 3/4"**



**MAGILL
01-140
20 cm, 8"**



**MAGILL
01-150
25 cm, 10"**

LARYNGOSCOPE & ACCESSORIES

Laryngoskope und Zubehör
Laringoscopios y Accessories

Laryngoscopes et accessories
Laringoscopi ed accessori



GUEDEL-NEGUS
01-160

Battery handle only
with for Laryngoscope
blades No. 1 to 4
complete, in case.



MCINTOSH
01-170

Fiber Optic Laryngoscope set
with 4 blades
(fig. 01 to 04) in wooden/ resin box.



Fig. 01
01-162

Fig. 02
01-164

Fig. 03
01-166

Fig. 04
01-168



BATTERY HANDLE
01-180
without battery
Use with battery - Size C
(01-162 - 01-168
01-172 - 01-178)

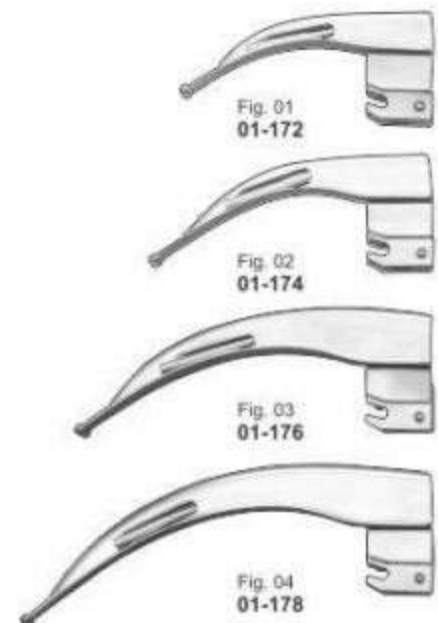

Fig. 01
01-172

Fig. 02
01-174

Fig. 03
01-176

Fig. 04
01-178

STETHOSCOPES

Stethoskope
Estetoscopios

Stéthoscopes
Stetoscopi

Blood Lancets

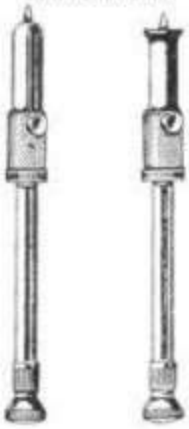

FRANCKE
01-190



FRANCKE
01-200

CHEST PIECES



BOWLES
01-210



FORD
01-220



LIGHT WEIGHT
01-230



SPRAGUE-BOWLES
01-240



BOWLES
01-250



FORD
01-260



BELL-END
01-270



SPARE RUBBER
01-280



DIAPHRAM
01-290



SCHIMMELBUSCH
01-300 ADULT
01-302 CHILD

INHALERS



AIRWAYS

YANKAUER
01-310 ADULT
01-312 CHILD



CONNELL
01-320 ADULT
01-322 CHILD

FRAMES



HEAD FRAME
(FOR LIHTWEIGHT)
01-330



HEAD FRAME
(FOR BINURAL)
01-332



BOWLES
01-334



FORD
01-336



FORD-BOWLES
01-338



LIGHTWEIGHT
01-340



PINARD
01-350 ALUMINIUM
01-351 WOODEN

PERCUSSION HAMMERS

Perkussionshämmer
Martillos de percusion

Marteaux-percuteurs
Martelli percussori



NEURO-DUOFLEX
01-360
22 cm, 8 1/4"



DEJERINE
01-370
20 cm, 8"



DEJERINE
01-380
20 cm, 8"



TROEMNER
01-390 145 g
01-392 175 g
01-394 235 g
24.5 cm, 9 1/4"
spare rubber



TROEMNER-SIMPLEX
01-400
21 cm, 8 1/4"



BUCK
01-410
18.5 cm, 7 1/2"



BUCK HAMMER
01-412
18 cm, 7"



TAYLOR
01-420 18 cm, 7"
01-422 20 cm, 8"



TAYLOR
01-424
18 cm, 7"



BABINSKY
01-430
22 cm, 8 1/4"



BABINSKY
01-432
22 cm, 8 1/4"



RABINER
01-434
25.5 cm, 10"
with needle & brush



BERLINER
01-440
20.0 cm, 8"



TRAUBE
01-450
16 cm, 6 1/4"



WARTENBERG
01-460
19 cm, 7 1/2"

TROCARS

Trokare
Trócares

Trocarts
Trequarti

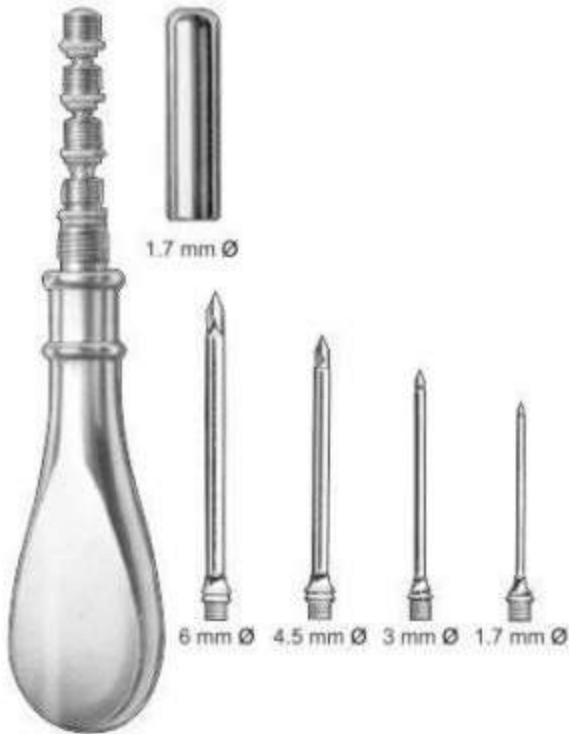

UNIVERSAL
01-470 Set of 4

1.7 mm Ø

6 mm Ø 4.5 mm Ø 3 mm Ø 1.7 mm Ø

UNIVERSAL
01-475 Set of 3

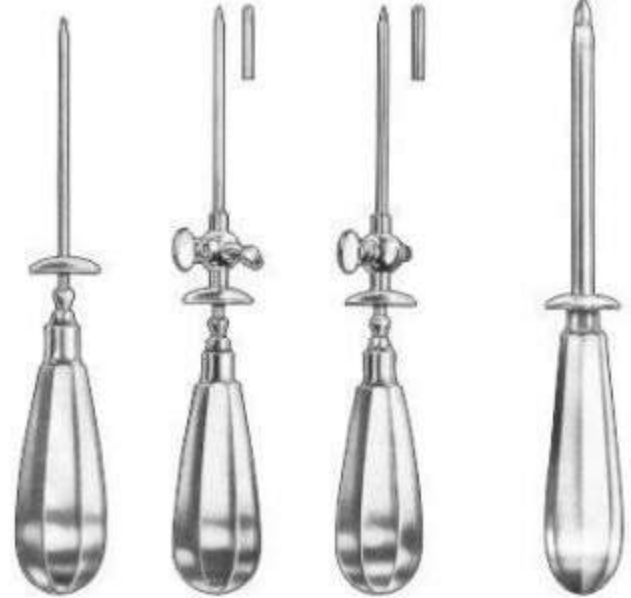

ABDOMINAL

- | | | |
|-----------------|-----------------|--------|
| 01-480 3.0 mm Ø | 01-487 3.0 mm Ø | 01-494 |
| 01-481 3.5 mm Ø | 01-488 3.5 mm Ø | 01-495 |
| 01-482 4.0 mm Ø | 01-489 4.0 mm Ø | 01-496 |
| 01-483 3.5 mm Ø | 01-490 3.5 mm Ø | 01-497 |
| 01-484 5.0 mm Ø | 01-491 5.0 mm Ø | 01-498 |
| 01-485 5.5 mm Ø | 01-492 5.5 mm Ø | 01-499 |
| 01-486 6.0 mm Ø | 01-493 6.0 mm Ø | 01-500 |

NELSON

- 01-505 25 Fg.
01-506 25 Fg.
01-507 25 Fg.
01-508 25 Fg.



HYDROCELE
01-510 8Fg.
01-511 9Fg.
01-512 10Fg.

ACITES
01-520 16Fg.
01-521 21Fg.

FLEURANT
01-530

FLEURANT
01-532

KRAUSE
01-540 5.5mm Ø

LICHTWITZ
01-550 1.75mm Ø

OCHSNIER
01-560 10Fg.
01-561 12Fg.
01-562 14Fg.
01-563 16Fg.
01-564 18Fg.
01-565 20Fg.

SUCTION TUBES

Sauger, Saugrohre
Tubos de aspiración

Tubos d'aspiracion
Tubi d'aspirazion



POOL
01-570 30 Fg.



POOL
01-575 30 Fg.



COOLEY
01-580
33.0 cm, 13"



COOLEY
01-585
35 cm, 13 3/4"



COOLEY
01-590
30.0 cm, 12"



COOLEY
01-595
31.0 cm, 12 1/2"



MILLIN'S SUCTION TUBE
01-600
chromium-plated,
with sliding "on & off"
action.



YANKAUER
01-605



YANKAUER
01-610
28.5 cm, 11"
with especially large
central bore, 4.8 mm
diam



YANKAUER
01-615
28.5 cm, 11"
with central bore,
2.0 mm Diam.



DE-BAKEY
01-620
28.5 cm, 11"
with central bore,
3.0 mm Diam. With
lateral slots

SUCTION TUBES

Sauger, Saugrohre
Tubos de aspiración

Tubos d'aspiracion
Tubi d'aspirazion



COUPLAND
01-630



BYRD
01-640 1.5 mm
01-645 2.5 mm
01-650 3.5 mm



DE-BAKEY
01-660
16 cm, 5"
with finger cut-off
and stylet



01-665
19 cm, 7 1/4"
cut-off



DE-BAKEY
01-670
27 cm, 10 1/4"
with finger cut-off
and stylet



01-680 Ø 4.5 mm
01-690 Ø 5.5 mm
17.5 cm, 7"
Nasal suction tubes



LOPEZ-REINKE
01-700
23.5 cm, 9"
tonsil dissector with
suction device



FERGUSON
01-710 Ø 4.0 mm
18 cm, 7"
insulated, with finger
cut-off and stylet, thumb
piece 90° to curved, with
Luer hub



FRAZIER
01-720 Ø 3.0 mm
01-725 Ø 5.0 mm
18 cm, 7"
insulated, with finger
cut-off and stylet, thumb
piece 90° to curved, with
Luer hub



01-730
18 cm, 7"
Ø 5.0 mm diam., Tip
6.5 mm wide nasal
section tube, with
luer hub

DISSECTING KITS

Diagnostik-bestecke
Diagnostic Sets

Estuches de diagnostico
Combinazioni per diagnostica

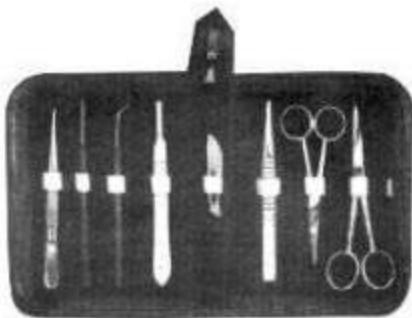

01-740

Set of 9 Pcs.

- Dissecting Forceps 11.5cm Sharp Point.
- Teasing needle Sharp STR.
- Teasing Needle Sharp Angular.
- B.P Handle No.4.
- Blade No. 22.
- Thumb Forcep T.O.E 13cm.
- Dissecting Scissor STR 11.5cm.
- Dissecting Scissor STR 13cm.
- Zipper Case Inside Red Velvet.

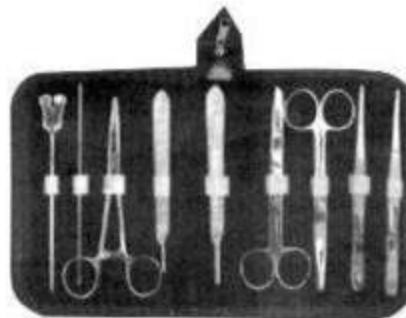

01-750

Set of 10 Pcs.

- Grooved Director with Tongue Tie 14cm.
- Probe Double 14cm.
- Mayo Hegar Needle Holder 14cm.
- B.P Handle No.3
- B.P Handle No.4
- Dressing Scissor 14cm S/B STR.
- Dressing Scissor 14cm S/B CVD.
- Dressing Forcep 1x2 teeth 14cm.
- Dressing Forcep Serrated 14cm.
- Zipper Case Inside Red Velvet.



01-760

Set of 10 Pcs.

- Probe Double 13cm.
- 2PCS. Scalpel S.S.
- Grooved Director With Tongue Tie 14cm
- Mayo Hegar Needle Holder 14cm.
- Dissecting Forceps 14cm 1x2 Teeth.
- Dressing Forceps 14cm Serrated.
- Dressing Scissor 14cm S/B STR.
- Dressing Scissor 14cm S/B CVD.
- Zipper Case Inside Red Velvet.

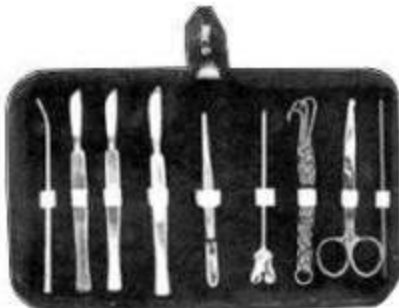

01-770

Set of 10 Pcs.

- Blow Pipe.
- 3PCS Scalpel.
- Dissecting Forceps 14cm.
- Grooved Director With Tongue Tie 14cm
- Triple Chain Hook.
- Dressing Scissor Probe Pointed 14cm.
- Probe Double 14 cm.
- Zipper Case Inside Red Velvet.



DISSECTING SET

01-780 Containing 9 Instruments

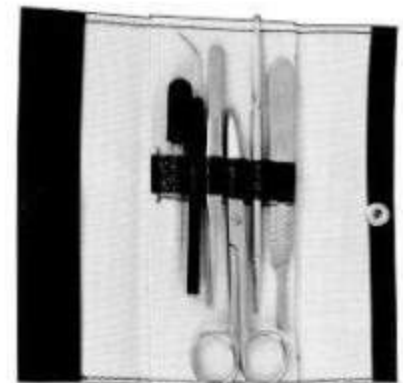

01-790

Set of 6 pcs.

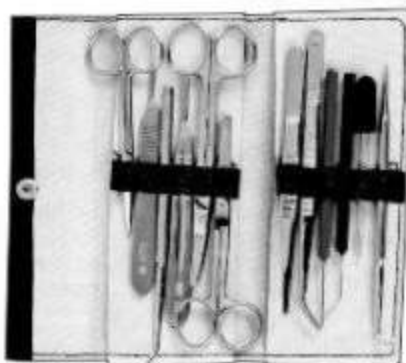

01-800

Set of 12 pcs.



DISSECTING KET

01-810

Set of 2 pcs.

SCALPEL HANDLES

Skalpelligriffe
Mangos de bisturíes

Manches pour bistouris
Manici per bisturi



#3 SCALPEL HANDLE
02-100
12.75 cm, 5"
Blade Size:
10, 11, 12, 15



#3 SCALPEL HANDLE/ GRADUATED
02-110
12.75 cm, 5"
Blade Size:
10, 11, 12, 15



#4 SCALPEL HANDLE
02-120
12.75 cm, 5"
Blade Size:
20, 22, 25



4L SCALPEL HANDLE
02-130
21 cm, 8 1/4"



SCALPEL PLASTIC HANDLE
02-140
8



COLLIN
02-150
9



Fig. 10
Blade Sizes



Fig. 11



Fig. 12



Fig. 15



Fig. 20



Fig. 22



SCALPEL PLASTIC HANDLE
02-160
5



SCALPEL PLASTIC HANDLE
02-170
6



#3, #4 SCALPEL HANDLE
02-180
16 cm, 6"



SCALPEL HANDLE 3L LONG
02-190 21 cm, 8 1/4"
Blade Size 10, 11, 12, 15



#7 SCALPEL HANDLE
02-200
16.5 cm, 6 1/4"
Blade 10, 11, 12, 15



SCALPEL HANDLE 4L long
02-210
21 cm, 8 1/4"



#3 SCALPEL HANDLE / LONG ANGLED
02-220
20.25 cm, 8 1/4"
Blade Size 10, 11, 12, 15

SCALPEL HANDLES

Skalpgriffe
Mangos de bisturíes

Manches pour bistouris
Manici per bisturi



**SCALPEL
HANDLE**
02-230
16 cm, 6 1/4"



**SCALPEL
HANDLE**
02-240
11.5 cm, 4 1/2"



**SCALPEL
HANDLE**
02-250
12.7 cm, 5"



**SCALPEL
HANDLE**
02-260
12.7 cm, 5"



**SCALPEL
HANDLE**
02-270
11 cm, 4 1/4"



**SCALPEL
HANDLE**
02-280
13.5 cm, 5 1/4"



**SCALPEL
HANDLE**
02-290
12 cm, 4 3/4"



TROUTMAN-CHRIS
02-300
9 cm, 3 1/2"



TROUTMAN-CHRIS
02-310
9 cm, 3 1/2"



**BLADE HOLDER
BLADE BREAKER**
02-320
11 cm, 4 1/4"



CASTROVIEJO
02-330
13 cm, 5 1/4"

DISSECTING KNIVES

Anatomische skalpelle
Bisturías para disección

Bistouris à dissection
Bisturi para dissezione



Fig. 1
02-340
16 cm, 6 1/4"



Fig. 2
02-341
16 cm, 6 1/4"



Fig. 3
02-342
16 cm, 6 1/4"



Fig. 4
02-343
16 cm, 6 1/4"



Fig. 5
02-344
16 cm, 6 1/4"



Fig. 6
02-345
16 cm, 6 1/4"



Fig. 7
02-346
16 cm, 6 1/4"



Fig. 8
02-347
16 cm, 6 1/4"



Fig. 9
02-348
16 cm, 6 1/4"



Fig. 15
02-349
16 cm, 6 1/4"



Fig. 16
02-350
16 cm, 6 1/4"



02-360
17 cm, 6 1/4"



DIEFFENBACH
02-370
16 cm, 6 1/4"



DISSECTING KNIFE
02-380 15 cm, 6"
with metal handle

DIEFFENBACH
16 cm, 6 1/4"



Fig. 1
02-390
14.5 cm, 5 3/4"



Fig. 2
02-391
14.5 cm, 5 3/4"



Fig. 3
02-392
14.5 cm, 5 3/4"



Fig. 4
02-393
14.5 cm, 5 3/4"



Fig. 5
02-394
14.5 cm, 5 3/4"



Fig. 6
02-395
14.5 cm, 5 3/4"



Fig. 1
02-410
13.5 cm,
5 1/4"



Fig. 2
02-411
13.5 cm,
5 1/4"



Fig. 3
02-412
13.5 cm,
5 1/4"



Fig. 4
02-413
13.5 cm,
5 1/4"



Fig. 5
02-414
13.5 cm,
5 1/4"



Fig. 6
02-415
13.5 cm,
5 1/4"



Fig. 7
02-416
13.5 cm,
5 1/4"



Fig. 8
02-417
13.5 cm,
5 1/4"



Fig. 9
02-418
13.5 cm,
5 1/4"



Fig. 10
02-419
13.5 cm,
5 1/4"

COLLIN
14.5 cm, 5 3/4"

DIEFFENBACH
13.5 cm

DISSECTING KNIVES

Anatomische skalpelle
Bisturías para disección

Bistouris à dissection
Bisturi para dissezione



02-430
17 cm, 6 3/4"



Fig. 1
02-431
17 cm, 6 3/4"



Fig. 3
02-432
17 cm, 6 3/4"



Fig. 5
02-433
17 cm, 6 3/4"



Fig. 7
02-434
17 cm, 6 3/4"



Fig. 9
02-435
17 cm, 6 3/4"



Fig. 10
02-436
17 cm, 6 3/4"



Fig. 12
02-437
17 cm, 6 3/4"



Fig. 14
02-438
17 cm, 6 3/4"



Fig. 16
02-439
17 cm, 6 3/4"



Fig. 18
02-440
17 cm, 6 3/4"



DISSECTING KNIFE
15 cm, 6"
with metal handle



02-450
15 cm, 6"

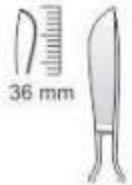

02-451
15 cm, 6"



02-452
15.5 cm, 6"



02-453
16 cm, 6 1/4"



02-454
16 cm, 6 1/4"



02-455
15 cm, 6"

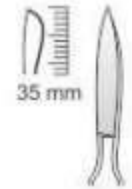

02-456
15 cm, 6"

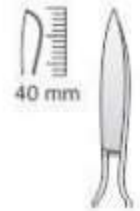

02-457
16 cm, 6 1/4"

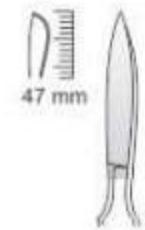

02-458
16 cm, 6 1/4"

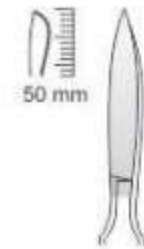

02-459
17 cm, 6 3/4"



DISSECTING KNIVES

Anatomische skalpelle
Bisturías para disección

Bistouris à dissection
Bisturi para dissezione



AYRE
02-470
23.5 cm, 9"
Cone Knife



02-480
23 cm, 9"
Cone Knife



SEGOND
02-490
27 cm, 11"
Myomatome



OLIVECRONA
02-500
20.5 cm, 8"
Trigeminal knife



02-510
23 cm, 9"
Trigeminal knife



FOWLER
02-520
20 cm, 8"
Tonsil knife



ABRAHAM
02-530
21.5 cm, 8 1/4"
Tonsil knife



BRUNINGS
02-540
21.5 cm, 8 1/4"
Tonsil knife



DIEFFENBACH
02-550
13 cm, 5"



DIEFFENBACH
02-560
13 cm, 5"



SIMON
02-570
23.5 cm, 9 1/4"



Fig. 1
02-571



Fig. 2
02-572



Fig. 3
02-573



Fig. 4
02-574

DISSECTING KNIVES

Anatomische skalpelle
Bisturías para disección

Bistouris à dissection
Bisturi para dissezione



DISSECTING KNIFE
02-580
15 cm, 6"
with metal handle



Fig.1



Fig.2



Fig.3



Fig.4



Fig.5



Fig.6



Fig.7



Fig.8



Fig.9



Fig.10



RAZOR
02-590
Hollow Blades On
Both Sides
02-591
Blade Flat / Hollow



COLLIN Blade
02-600 13 cm, 5"
02-601 16 cm, 6 ¼"
02-602 19 cm, 7 ½"
02-603 22 cm, 8 ½"
02-604 28 cm, 11 ¼"



CATLIN Blade
02-610 16 cm, 6 ¼"
02-611 19 cm, 7 ½"
02-612 22 cm, 8 ½"



LISTON Blade
02-620 16 cm, 6 ¼"
02-621 19 cm, 7 ½"
02-622 22 cm, 8 ½"



LANGENBECK Blade
02-630
12 cm, 4 ¾"



RESECTION KNIFE
02-640
18 cm, 7"

AMPUTATION, RESECTION & DISSECTING KNIVES

Amputationsmesser, Cuchillos para amputación, Anatomische skalpelle
Couteaux à amputation, coltelli per amputazione, Bisturie para disección

Resektionsmesser, Cuchillos para resección, Bistouris à dissection
Couteaux à résection, Coltelli per resezione, Bisturi para dissezione



COLLIN Blade
02-660 13 cm, 5"
02-661 16 cm, 6 1/4"
02-662 19 cm, 7 1/2"
02-663 22 cm, 8 1/2"
02-664 28 cm, 11 1/4"



CATLIN Blade
02-670 16 cm, 6 1/4"
02-671 19 cm, 7 1/2"
02-672 22 cm, 8 1/2"
02-673 29 cm, 11 1/2"



LISTON Blade
02-680 16 cm, 6 1/4"
02-681 19 cm, 7 1/2"
02-682 22 cm, 8 1/2"



LANGENBECK Blade
02-690
12 cm, 4 3/4"



AMPUTATION KNIFE
02-700
29 cm, 11 1/2"
02-701
32.5 cm, 13"



RESECTION KNIFE
02-720
18 cm, 7"



LANGENBECK
02-730
18 cm, 7"



LANGENBECK
02-740
18 cm, 7"



WALB
02-750 11 cm, 4 1/2"
02-751 14 cm, 5 1/2"
02-752 17 cm, 6 1/2"



VIRCHOW
02-760 16 cm, 6 1/2"
02-761 20 cm, 8"
02-762 24 cm, 9 1/2"

OPERATING SCISSORS

Chirurgische scheren
 Tijeras quirúrgicas

Ciseaux chirurgicaux
 Forbici per chirurgia

ROUND PATTERN



STANDARD STRAIGHT

03-100	11.5 cm, 4 1/2"
03-101	13.0 cm, 5"
03-102	14.0 cm, 5 1/2"
03-103	15.0 cm, 6"
03-104	16.0 cm, 6 1/4"
03-105	17.5 cm, 7"
03-106	18.5 cm, 7 1/4"
03-107	20.0 cm, 8"
S/S Str.	

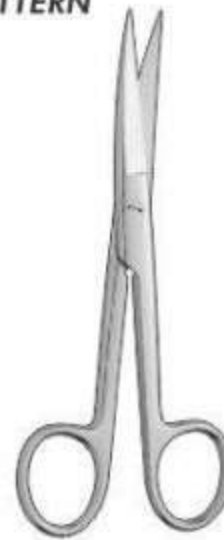

STANDARD CURVED

03-120	11.5 cm, 4 1/2"
03-121	13.0 cm, 5"
03-122	14.0 cm, 5 1/2"
03-123	15.0 cm, 6"
03-124	16.0 cm, 6 1/4"
03-124	17.5 cm, 7"
03-125	18.5 cm, 7 1/4"
03-126	20.0 cm, 8"
S/S Cvd.	



STANDARD STRAIGHT

03-140	11.5 cm, 4 1/2"
03-141	13.0 cm, 5"
03-142	14.0 cm, 5 1/2"
03-143	15.0 cm, 6"
03-144	16.0 cm, 6 1/4"
03-145	17.5 cm, 7"
03-146	18.5 cm, 7 1/4"
03-147	20.0 cm, 8"
B/B Str.	



STANDARD CURVED

03-160	11.5 cm, 4 1/2"
03-161	13.0 cm, 5"
03-162	14.0 cm, 5 1/2"
03-163	15.0 cm, 6"
03-164	16.0 cm, 6 1/4"
03-165	17.5 cm, 7"
03-166	18.5 cm, 7 1/4"
03-167	20.0 cm, 8"
B/B Cvd.	



STANDARD STRAIGHT

03-180	11.5 cm, 4 1/2"
03-181	13.0 cm, 5"
03-182	14.0 cm, 5 1/2"
03-183	15.0 cm, 6"
03-184	16.0 cm, 6 1/4"
03-185	17.5 cm, 7"
03-186	18.5 cm, 7 1/4"
03-187	20.0 cm, 8"



STANDARD CURVED

03-200	11.5 cm, 4 1/2"
03-201	13.0 cm, 5"
03-202	14.0 cm, 5 1/2"
03-203	15.0 cm, 6"
03-204	16.0 cm, 6 1/4"
03-205	17.5 cm, 7"
03-206	18.5 cm, 7 1/4"
03-207	20.0 cm, 8"

OPERATING, DISSECTING SCISSORS

Chirurgische scheren, Präparierscheren
Tijeras quirúrgicas, Tijeras de disección

Ciseaux chirurgicaux, Ciseaux à dissection
Forbici per chirurgia, Forbici per dissezione



DEAVER
03-220
14.0 cm, 5 1/2"

DEAVER
03-230
14.0 cm, 5 1/2"

MIXTER
03-240
15.5 cm, 6"

MIXTER
03-250
15.5 cm, 6"

JORGENSON
03-260
22 cm, 8 1/2"
Curved



INCISION SCISSORS
03-270 13.0 cm, 5"
03-271 14.5 cm, 5 1/2"

INCISION SCISSORS
03-280
15.5 cm, 6"

RICHTER
03-290
14.5 cm, 5 1/2"

FERGUSSON
03-300 14.0 cm, 5 1/2"
03-311 16.5 cm, 6 1/2"
03-312 18.0 cm, 7"

OPERATING & DISSECTING SCISSORS

Chirurgische scheren, Präparierscheren
Tijeras quirúrgicas, Tijeras de disección

Ciseaux chirurgicaux, Ciseaux à dissection
Forbici per chirurgia, Forbici per dissezione

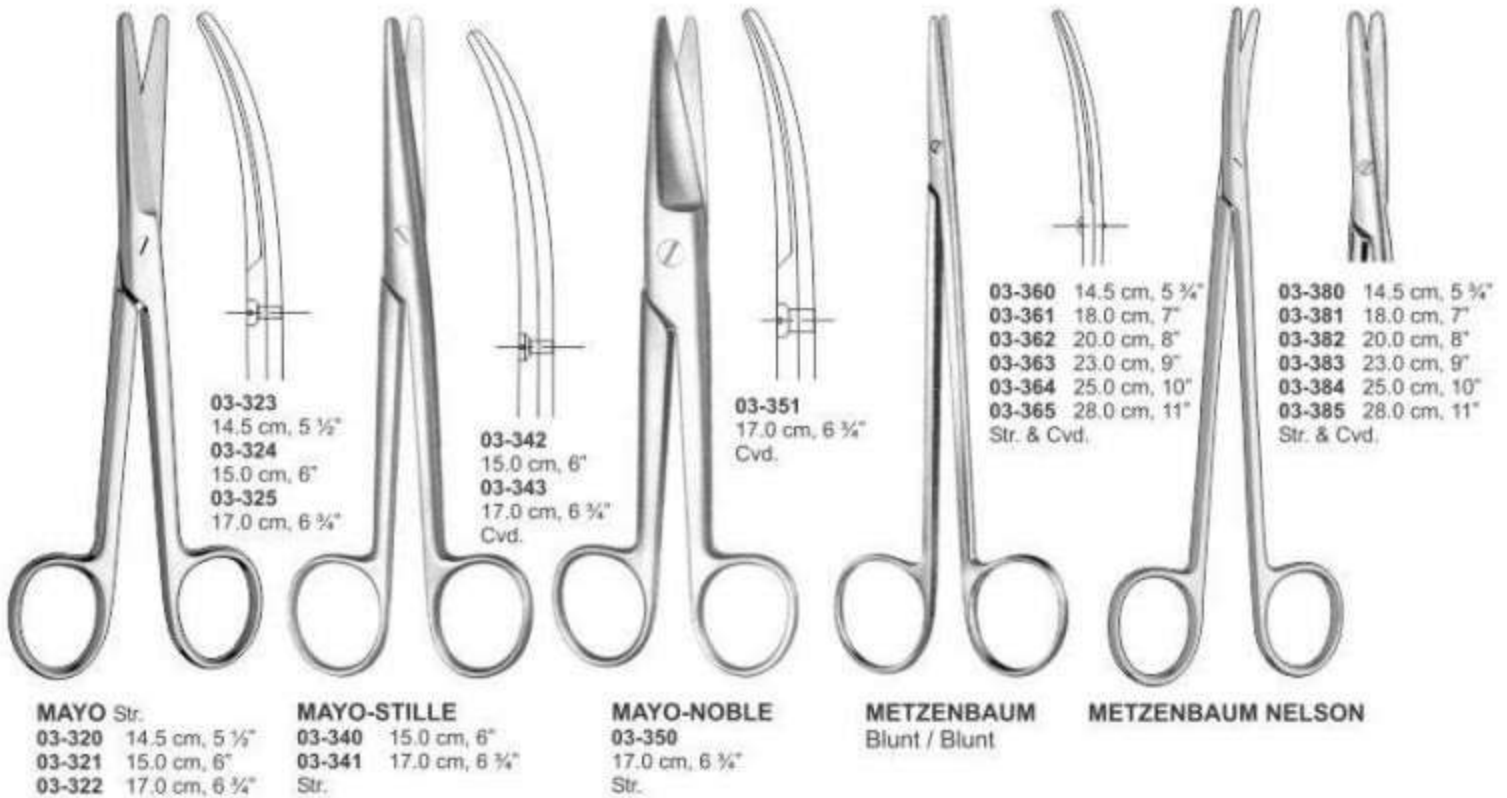

FACE-LIFT, DISSECTING, NASAL SCISSORS & OPERATING

Face-lift, Präparierscheren, Nasenscheren, Chirurgische scheren
face-Lift, Tijeras de disección, Tijeras nasales, Tijeras quirúrgicas

Face-lift, Ciseaux à dissection, Ciseaux nasaux, Ciseaux chirurgicaux
Face-lift, Forbici per dissezione, Forbici nasali, Forbici per chirurgia



LEXER-BABY
03-441
10.0 cm, 4"

LEXER-BABY
03-440
10.0 cm, 4"

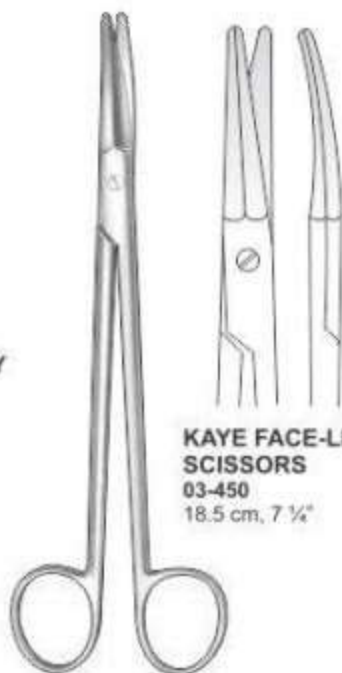

**KAYE FACE-LIFT
SCISSORS**
03-450
18.5 cm, 7 1/4"

**KAYE FACE-LIFT
SCISSORS**



03-460
13.5 cm, 5 1/4"

FOMON

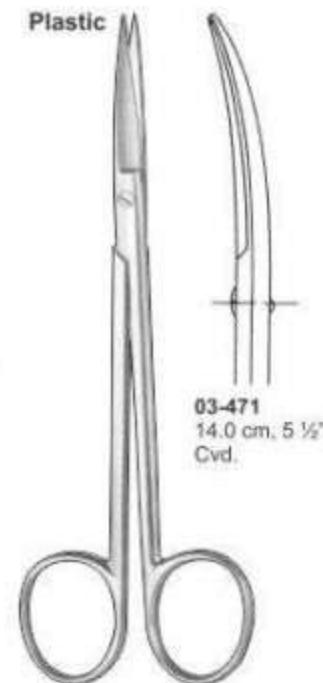

03-471
14.0 cm, 5 1/2"
Cvd.

JOSEPH
03-470
14.0 cm, 5 1/2"
Str.



KILNER
03-480 12.0 cm, 4 3/4"
03-481 15.0 cm, 6"
03-482 18.0 cm, 7"
03-483 20.0 cm, 8"
Str.

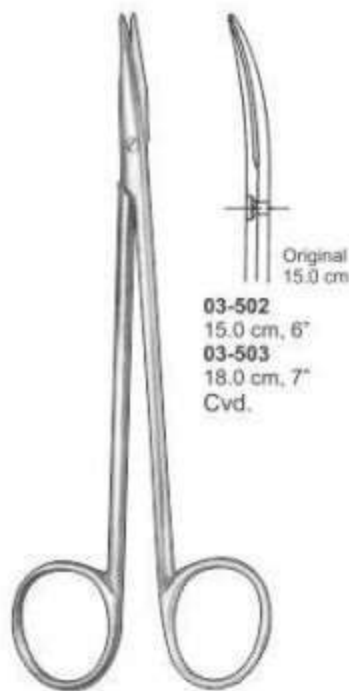

03-502
15.0 cm, 6"
03-503
18.0 cm, 7"
Cvd.

REYNOLDS
03-500 15.0 cm, 6"
03-501 18.0 cm, 7"
Str.

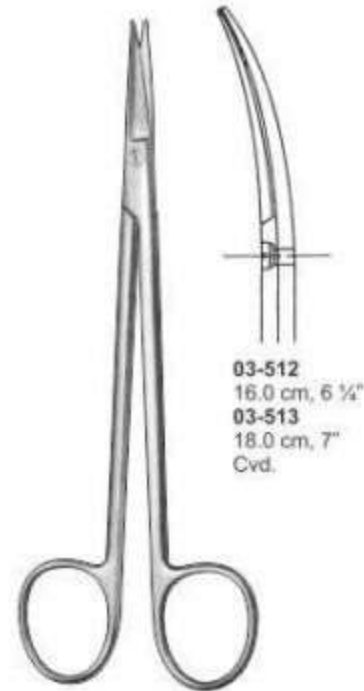

03-512
16.0 cm, 6 1/4"
03-513
18.0 cm, 7"
Cvd.

KELLY
03-510 16.0 cm, 6 1/4"
03-511 18.0 cm, 7"
Str.

GYNECOLOGICAL, IRIS & TENDON SCISSORS

Gynäkologische Scheren, Irisscheren, Schnenscheren
Tijeras para ginecología, Tijeras para Iridectomía, Tijeras para tendones

ciseaux à gynécologie, Ciseaux à iridectomie, Ciseaux à Ténatomie
Forbici per ginecologia, Forbici per iridectomia, Forbici per tenotomia



DOYEN
03-520
16.0 cm, 6 1/4"
S/B, Str.



DOYEN
03-530
16.0 cm, 6 1/4"
B/B, Str.



DOYEN
03-540
17.5 cm, 6 3/4"
B/B, Str.



03-541
17.5 cm, 6 3/4"
B/B, Cvd.



CARDINALE
03-550
28.0 cm, 11"



SIMS
03-551 20.0 cm, 8"
03-552 23.0 cm, 9"
Straight, B/B



03-553
20.0 cm, 8"
03-554
23.0 cm, 9"
S/B



03-555
20.0 cm, 8"
03-556
23.0 cm, 9"
S/S



03-557
20.0 cm, 8"
03-558
23.0 cm, 9"
S/B



03-559
20.0 cm, 8"
03-560
23.0 cm, 9"
S/S



03-570 09 cm, 3 1/2"
03-571 10.5 cm, 4 1/4"
03-572 11.5 cm, 4 1/2"
03-573 12.0 cm, 4 3/4"
Str.



03-574 09 cm, 3 1/2"
03-575 10.5 cm, 4 1/4"
03-576 11.5 cm, 4 1/2"
03-577 12.0 cm, 4 3/4"
Cvd.

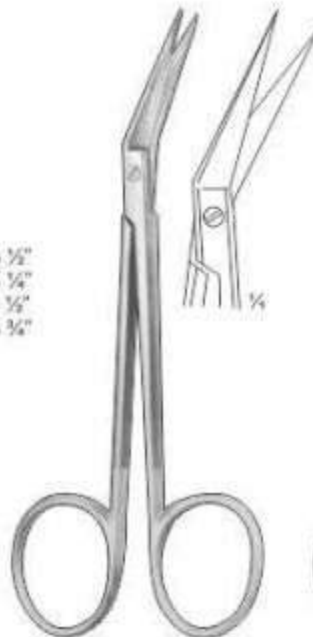

IRIS ANGULAR
03-590
11cm 4 1/4"

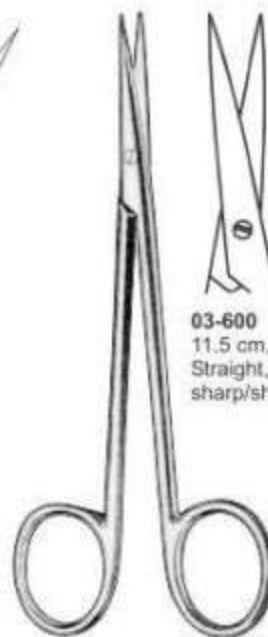

03-600
11.5 cm, 4 1/2"
Straight,
sharp/sharp

KILLNER

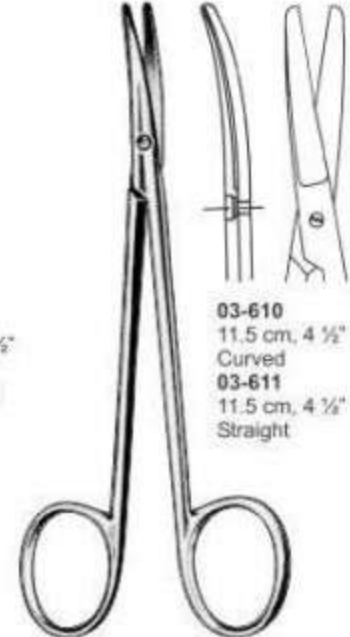

03-610
11.5 cm, 4 1/2"
Curved
03-611
11.5 cm, 4 1/2"
Straight

STRABISMUS

DISSECTING & VASCULAR SCISSORS

Präparierscheren, Gefäßscheren
Tijeras de disección, Tijeras vasculares

Ciseaux à dissection, Ciseaux vasculaires
Forbici per dissezione, Forbici vascolari



**POTTS-REYNOLDS
TENOTOMY**
03-620
12.0 cm, 4 3/4"
Curved



POTTS TENOTOMY
03-630 15.2 cm, 6"
03-631 17.8 cm, 7"
03-632 20.3 cm, 8"



SLAYER
03-635
10 cm

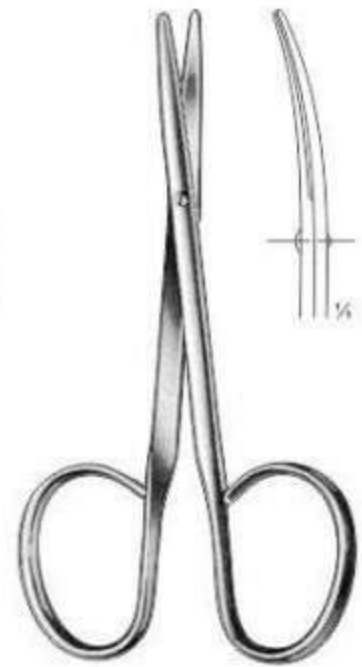

03-640
10.0 cm, 4"
Straight

03-641
10.0 cm, 4"
Curved

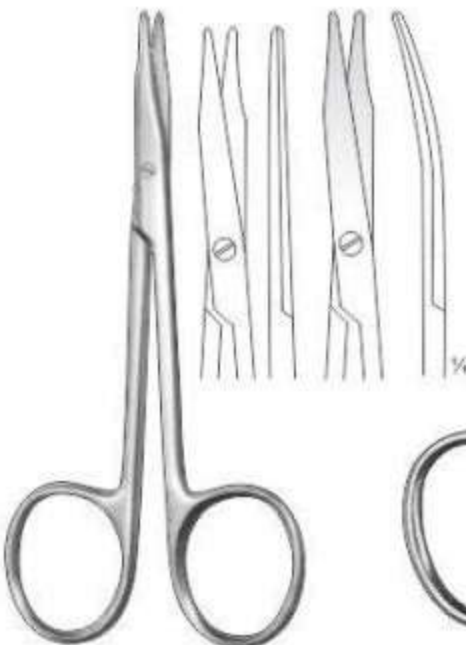

TENOTOMY-STEVENS
03-650 Straight
03-651 Curved
11 cm, 4 1/4"

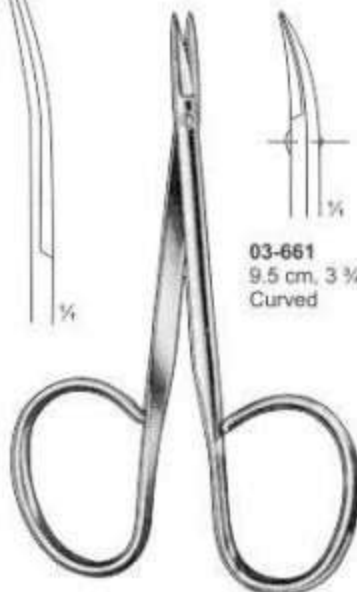

TENOTOMY
03-660
9.5 cm, 3 3/4"
Straight

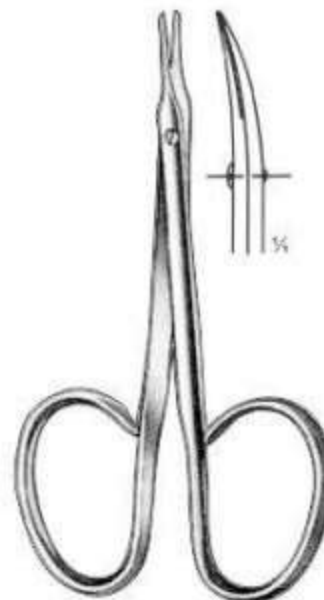

TENOTOMY
03-670
9.5 cm, 3 3/4"
Curved-Ribbon
Handles blunt/blunt



**COOLEY REVERSE
Cut Scissors**
03-680
angled 120°
17.1 cm, 6 3/4"

VASCULAR SCISSORS

Gefäßscheren
Tijeras vasculares

Ciseaux vasculaires
Forbici vascolari



- POTTS-SMITH**
 03-690 19.1 cm, 7 1/2" angled 25°
 03-691 13.3 cm, 5 1/4" angled 45°
 03-692 19.1 cm, 7 1/2" angled 45°
 03-693 19.1 cm, 7 1/2" angled 60°
 03-694 19.1 cm, 7 1/2" angled 90°

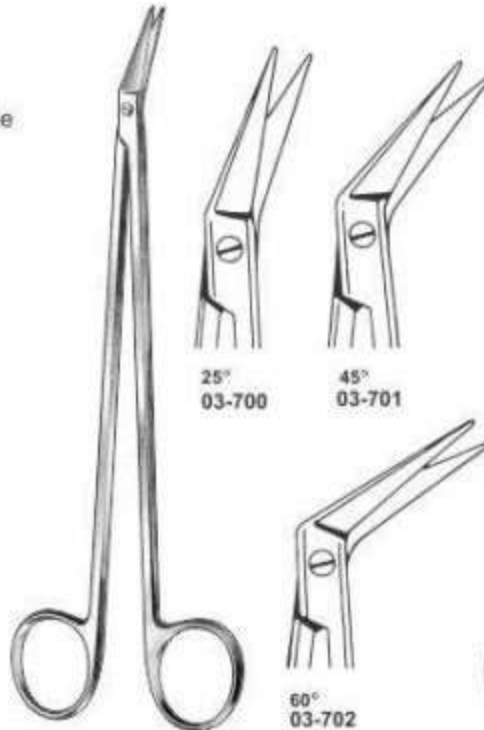

- POTTS-SMITH**
 03-700 19.0 cm, 7 1/2" angled 25°
 03-701 19.0 cm, 7 1/2" angled 45°
 03-702 19.0 cm, 7 1/2" angled 60°

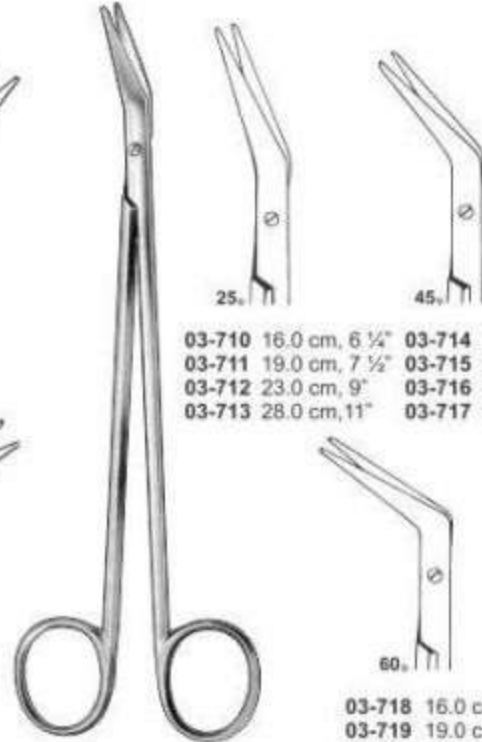

- DE BAKEY**

- 03-710 16.0 cm, 6 1/4" angled 25°
 03-711 19.0 cm, 7 1/2" angled 45°
 03-712 23.0 cm, 9" angled 45°
 03-713 28.0 cm, 11" angled 45°
 03-714 16.0 cm, 6 1/4" angled 60°
 03-715 19.0 cm, 7 1/2" angled 60°
 03-716 23.0 cm, 9" angled 60°
 03-717 28.0 cm, 11" angled 60°



- 03-718 16.0 cm, 6 1/4" angled 60°
 03-719 19.0 cm, 7 1/2" angled 60°
 03-720 23.0 cm, 9" angled 60°
 03-721 28.0 cm, 11" angled 60°

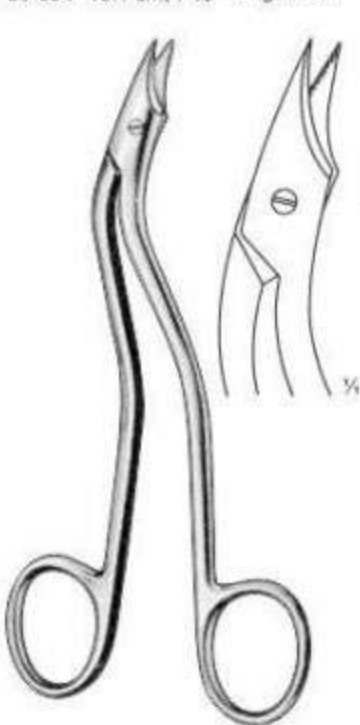

- HEATH**
 03-730 15.0 cm, 6" angled 45°
 03-731 15.0 cm, 6" angled 60°
 03-732 15.0 cm, 6" angled 90°

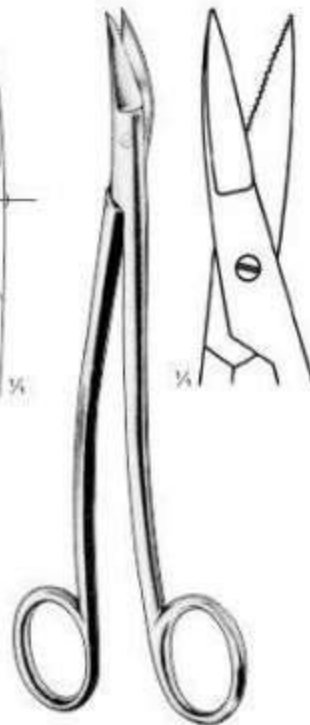

- ENT-DEAN**
 03-740 17 cm, 6 3/4" Serrated angled 45°
 03-741 17 cm, 6 3/4" Serrated angled 60°
 03-742 17 cm, 6 3/4" Serrated angled 90°



- STRULLY**
 03-750 22.0 cm, 8 3/4" angled 45°
 03-751 22.0 cm, 8 3/4" angled 60°
 03-752 22.0 cm, 8 3/4" angled 90°

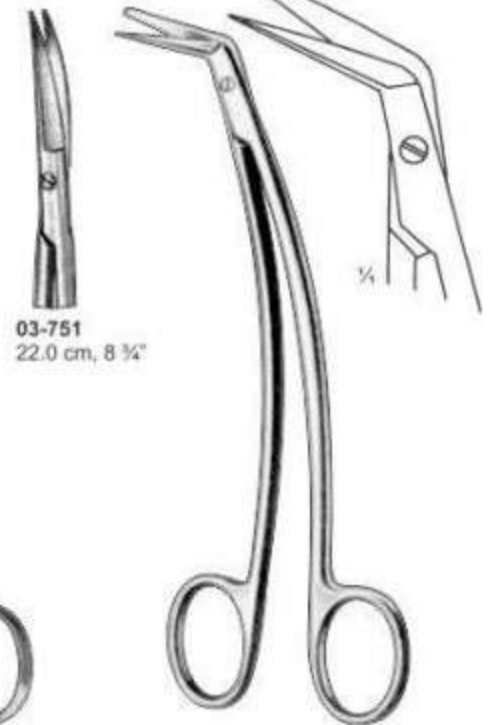

- FAVALORO**
 03-760 15.0 cm, 6" angled 45°
 03-761 15.0 cm, 6" angled 60°
 03-762 15.0 cm, 6" angled 90°

VASCULAR, ENTEROTOMY & TONSIL SCISSORS

Gefäßscheren, Darmscheren, Tonsillenscheren

Tijeras vasculares, Tijeras para intestino, Tijeras para amígdalas

Ciseaux vasculaires, Ciseaux-entérotomes, Ciseaux pour les amygdales

Forbici vascolari, Forbici per enterotomia, Forbici per tonsille

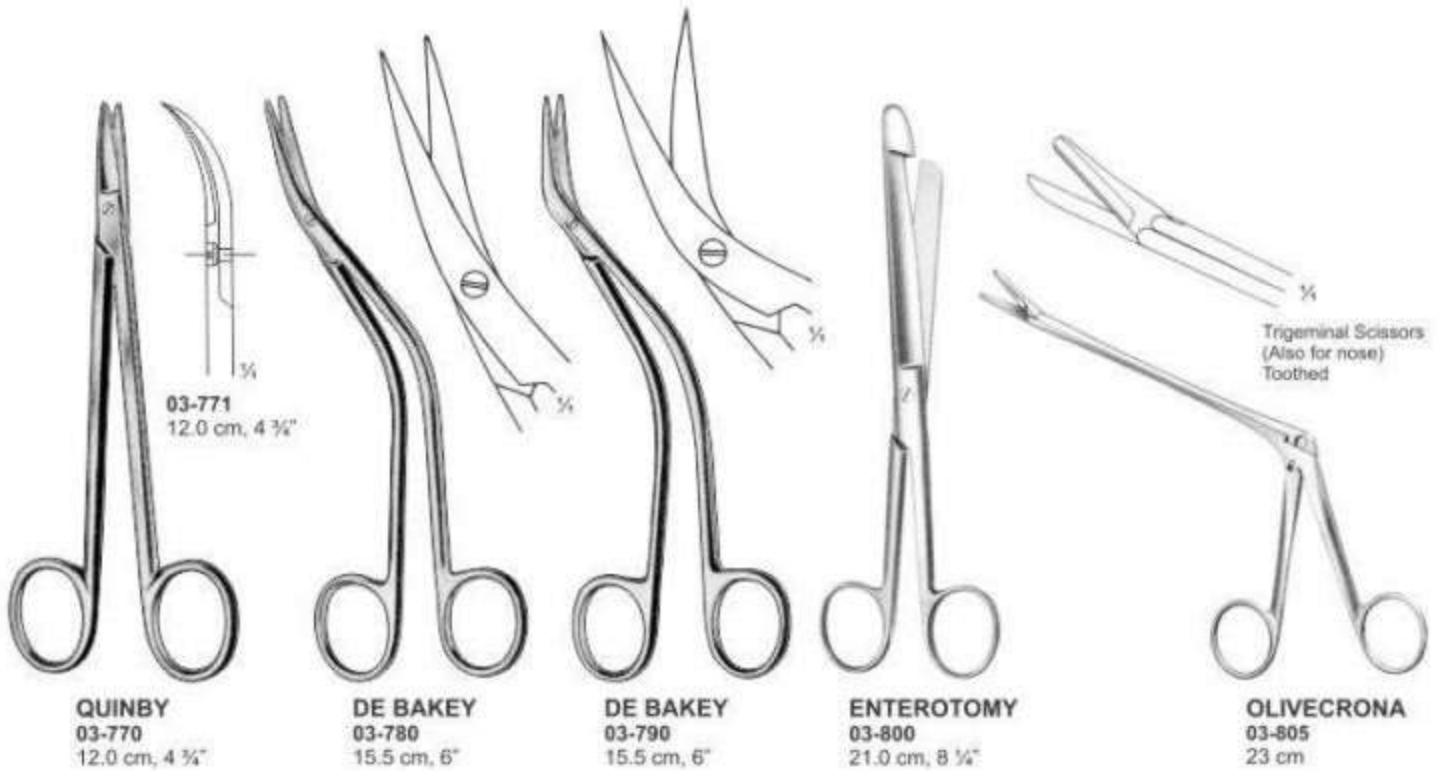

GUM, STITCH & WIRE CUTTING SCISSORS

Zahnfleischscheren, Fadenschere, Drahtschere

Ciseaux à gencives, Ciseaux à ligatures, Ciseaux à fils

Tijeras para encías, Tijeras para hilos, Tijeras para alambres

Forbici per gengiva, Forbici per legature, Forbici per filo metallico



ROUND CUT
03-860
23.5 cm, 9"

LE GRANGE
03-870
11 cm, 4 1/4"

SCHOEMAKER-LOTH
03-880
12.5 cm, 5"

SPENCER / DELICATE
03-890
11 cm, 4 1/2"

LITTAUER
03-900
14 cm, 5 1/2"

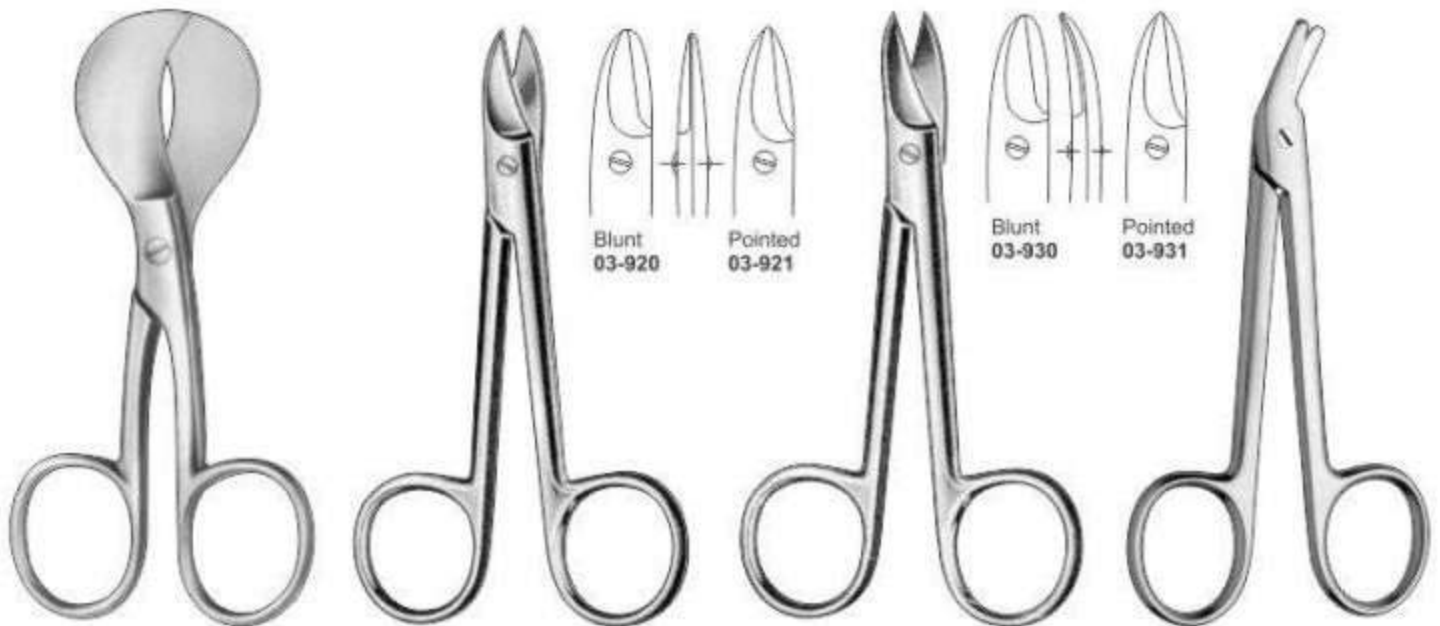

MODIFIED-USA
03-910
10 cm, 4"

BEEBEE
10.5 cm, 4"
Straight

BEEBEE
10.5 cm, 4"
Curved

UNIVERSAL
03-940
11.5 cm, 4 1/2"

MICRO SCISSORS

Mikroscheren
Micro scissors

Micro-Ciseaux
Micro-Forbici



CASTROVIEJO
9.0 cm, 3 1/2"



03-950
B/B



03-951
B/B



03-952
B/S



03-953
S/S



NOYES
03-960
12 cm, 4 1/4"



NOYES
A 03-970
B 03-971
C 03-972
12 cm, 4 1/4"

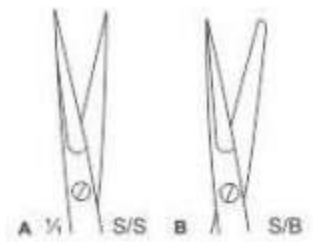

WESTCOTT
03-980
11.5 cm, 4 1/2"



WESTCOTT
03-990
11.5 cm, 4 1/2"



WESTCOTT



03-1000
11 cm, 4 1/2"
Curved
Sharp/Sharp

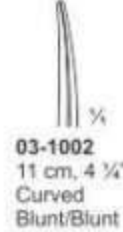

03-1002
11 cm, 4 1/2"
Curved
Blunt/Blunt



BARRAQUER
03-1010
03-1011
03-1012
5.5 cm, 2 1/4"

SUPER CUT SCISSORS

scheren
Tijeras

Ciseaux
Forbici



STANDARD
03-1020
14 cm, 5 1/2"
Straight



STANDARD
03-1030
14 cm, 5 1/2"
Curved



MAYO
03-1040 14 cm, 5 1/2"
03-1041 15 cm, 6"
03-1042 18 cm, 7"
03-1043 20 cm, 8"
03-1044 23 cm, 9"



MAYO
03-1050
23 cm, 9"
Curved



MAYO
03-1060
23 cm, 9"
Straight



GOLDMAN-FOX
03-1070 Straight
03-1071 Curved
9.0 cm, 3 1/2"



STEVENS TENOTOMY
03-1080 Straight
03-1081 Curved
9.0 cm, 3 1/2"



IRIS
03-1090
9.0 cm, 3 1/2"
03-1091
11.4 cm, 4 1/2"
Straight



IRIS
Angular
03-1100
11.4 cm, 4 1/2"

PLASTER SCISSORS

Gipsschere
Tijera para yeso

Ciseaux pour plâtre
Forbici per gesso



UNIVERSAL (Colour Available)
03-1110 14.5 cm, 5 1/2"
143 C/290 F Autoclavable
03-1111 15 cm, 6"
143 C/290 F Autoclavable
03-1112 16 cm, 6 1/4"
143 C/290 F Autoclavable
03-1113 18 cm, 7"
143 C/290 F Autoclavable



UNIVERSAL BANDAGE
03-1120
12 cm, 5"

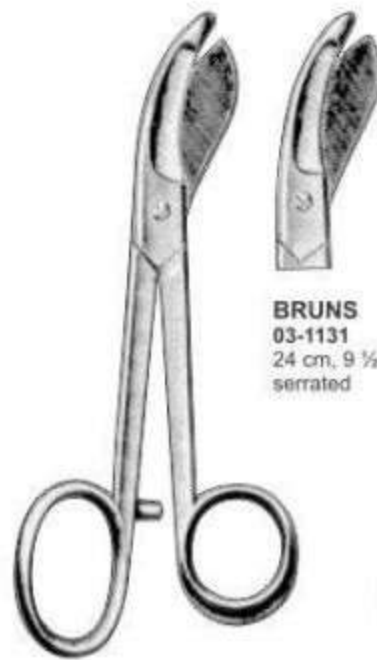

BRUNS
03-1130
24 cm, 9 1/2"
saw edge

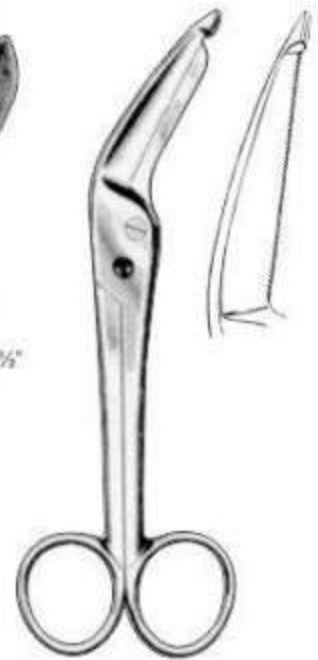

LISTER
03-1140
Exentric
19 cm, 7 1/2"



BERGMANN
03-1150
23 cm, 9"



ESMARCH
03-1160
20 cm, 8"
03-1161
22 cm, 8 1/4"



BRAUN-STADLER
03-1170
14 cm, 5 1/2"



BRAUN-STADLER
03-1180
20 cm, 8"



SMITH (MOD. USA)
03-1190 16 cm, 6 1/4"
03-1191 18 cm, 7"
03-1192 20 cm, 8"
03-1193 23 cm, 9"

PLASTER SCISSORS

Gipsschere
Tijera para yeso

Ciseaux pour plâtre
Forbici per gesso



for fingers

KNOWLES
03-1200
14 cm, 5 1/2"



LISTER
03-1210
21.0 cm, 8 1/4"



LISTER BANDAGE
03-1220 14 cm, 5 1/2"
03-1221 16 cm, 6 1/4"
03-1222 18 cm, 7"
03-1223 20 cm, 8"



LORENZ
03-1230
23 cm, 9"



KNOWLES
03-1240
14 cm, 5 1/2"



Saw Edge

LISTER-EXCENTRIC
03-1250 16 cm, 6 1/4"
03-1251 19 cm, 7 1/2"



KNOWLES
03-1260
14cm



ESMARCH
03-1270
20cm



SEUTIN
03-1280
23cm



WIRE & CLOTHING
03-1290
20cm

PLASTER SHEARS

Gipsschere
Tijera para yeso

Ciseaux pour plâtre
Forbici per gesso



SHEAR
STILLE
03-1300 23cm
03-1301 26cm
03-1302 37cm



SAW
ENGEL
03-1310



KNIFE
REINER
03-1320
18cm



RING CUTTER
FINGER
03-1330
16cm



CAST BREAKER
WOLFF
03-1340 19cm
03-1341 23cm
03-1342 26cm



SPREADER
HENING
03-1350
28cm



SPREADER
BEESON
03-1360
30cm

OPERATING SCISSORS T/C INSERTED

Chirurgische scheren
Tijeras quirúrgicas

Ciseaux chirurgicaux
Forbici per chirurgia



STANDARD

- 03-1370 14.5 cm, 5 3/4" Straight
- 03-1371 14.5 cm, 5 3/4" Curved
- 03-1372 16.5 cm, 6 1/2" Straight
- 03-1373 16.5 cm, 6 1/2" Curved
- 03-1374 18.5 cm, 7 1/4" Straight
- 03-1375 18.5 cm, 7 1/4" Curved



STANDARD

- 03-1390 14.5 cm, 5 3/4" Straight
- 03-1391 14.5 cm, 5 3/4" Curved
- 03-1392 16.5 cm, 6 1/2" Straight
- 03-1393 16.5 cm, 6 1/2" Curved
- 03-1394 18.5 cm, 7 1/4" Straight
- 03-1395 18.5 cm, 7 1/4" Curved



MAYO

- 03-1400 14 cm, 5 1/2"
- 03-1401 17 cm, 6 3/4"
- 03-1402 23 cm, 9"
- blunt/blunt



STANDARD

- 03-1410 14.5 cm, 5 3/4" Straight
- 03-1411 14.5 cm, 5 3/4" Curved
- 03-1412 16.5 cm, 6 1/2" Straight
- 03-1413 16.5 cm, 6 1/2" Curved
- 03-1414 18.5 cm, 7 1/4" Straight
- 03-1415 18.5 cm, 7 1/4" Curved



MAYO-STILLE

- 03-1430 15 cm, 6"
- 03-1431 17 cm, 6 1/2"
- blunt/blunt, Str.

- 03-1432 15 cm, 6"
- 03-1433 17 cm, 6 1/2"
- blunt/blunt, Cvd.



LEXER

- 03-1440 16 cm, 6 1/4"
- 03-1441 21.5 cm, 8 1/2"
- blunt/blunt, Str.

- 03-1442 16 cm, 6 1/4"
- 03-1443 21.5 cm, 8 1/2"
- blunt/blunt, Cvd.



OPERATING & DISSECTING SCISSORS T/C INSERTED

Chirurgische scheren, Präparierscheren
 Tijeras quirúrgicas, Tijeras de disección

Ciseaux chirurgicaux, Ciseaux à dissection
 Forbici per chirurgia, Forbici per dissezione

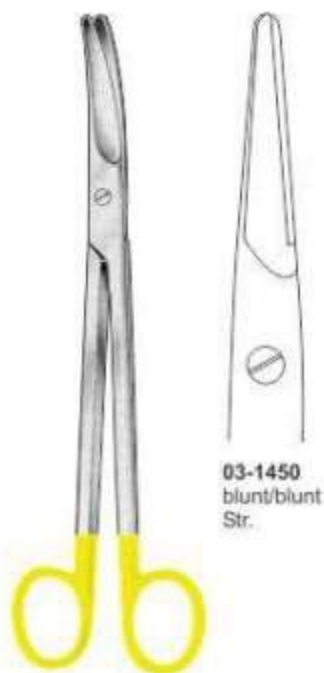

03-1450
 blunt/blunt
 Str.

PARAMETRIUM
 23 cm, 9"

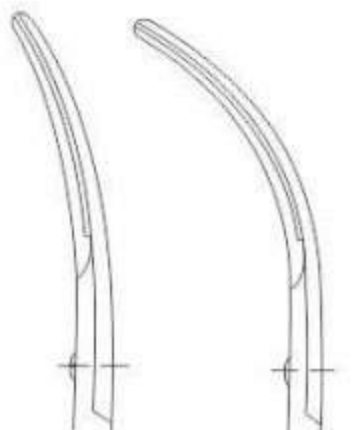

03-1451
 blunt/blunt
 Cvd.

03-1452
 blunt/blunt
 Full Cvd.



GOLDMAN-FOX
03-1460
 13.0 cm, 5"



CARDINALE
03-1470
 28.0 cm, 11"



SIMS
03-1480
 23.0 cm, 9"
 Curved



03-1490 14.5 cm, 5 3/4"
03-1491 18.0 cm, 7"
03-1492 20.0 cm, 8"
03-1493 23.0 cm, 9"
03-1494 25.0 cm, 10"
03-1495 28.0 cm, 11"
 Blunt / Blunt Curved

03-1496 14.5 cm, 5 3/4"
03-1497 18.0 cm, 7"
03-1498 20.0 cm, 8"
03-1499 23.0 cm, 9"
03-1500 25.0 cm, 10"
03-1501 28.0 cm, 11"
 Blunt / Blunt Straight

**METZENBAUM
 DELICATE**



03-1510 14.5 cm, 5 3/4"
03-1511 18.0 cm, 7"
03-1512 20.0 cm, 8"
03-1513 23.0 cm, 9"
03-1514 25.0 cm, 10"
03-1515 28.0 cm, 11"
 Sharp / Sharp Curved

03-1516 14.5 cm, 5 3/4"
03-1517 18.0 cm, 7"
03-1518 20.0 cm, 8"
03-1519 23.0 cm, 9"
03-1520 25.0 cm, 10"
03-1521 28.0 cm, 11"
 Sharp / Sharp Straight

**METZENBAUM
 DELICATE**

VASCULAR, DISSECTING & PLASTER SCISSORS T/C INSERTED

Gefäßscheren, Präparierscheren, Gipsschere

Ciseaux vasculaires, Ciseaux à dissection, Ciseaux pour plâtre

Tijeras vasculares, Tijeras de disección, Tijera para yeso

Forbici vascolari, Forbici per dissezione, Forbici per gesso

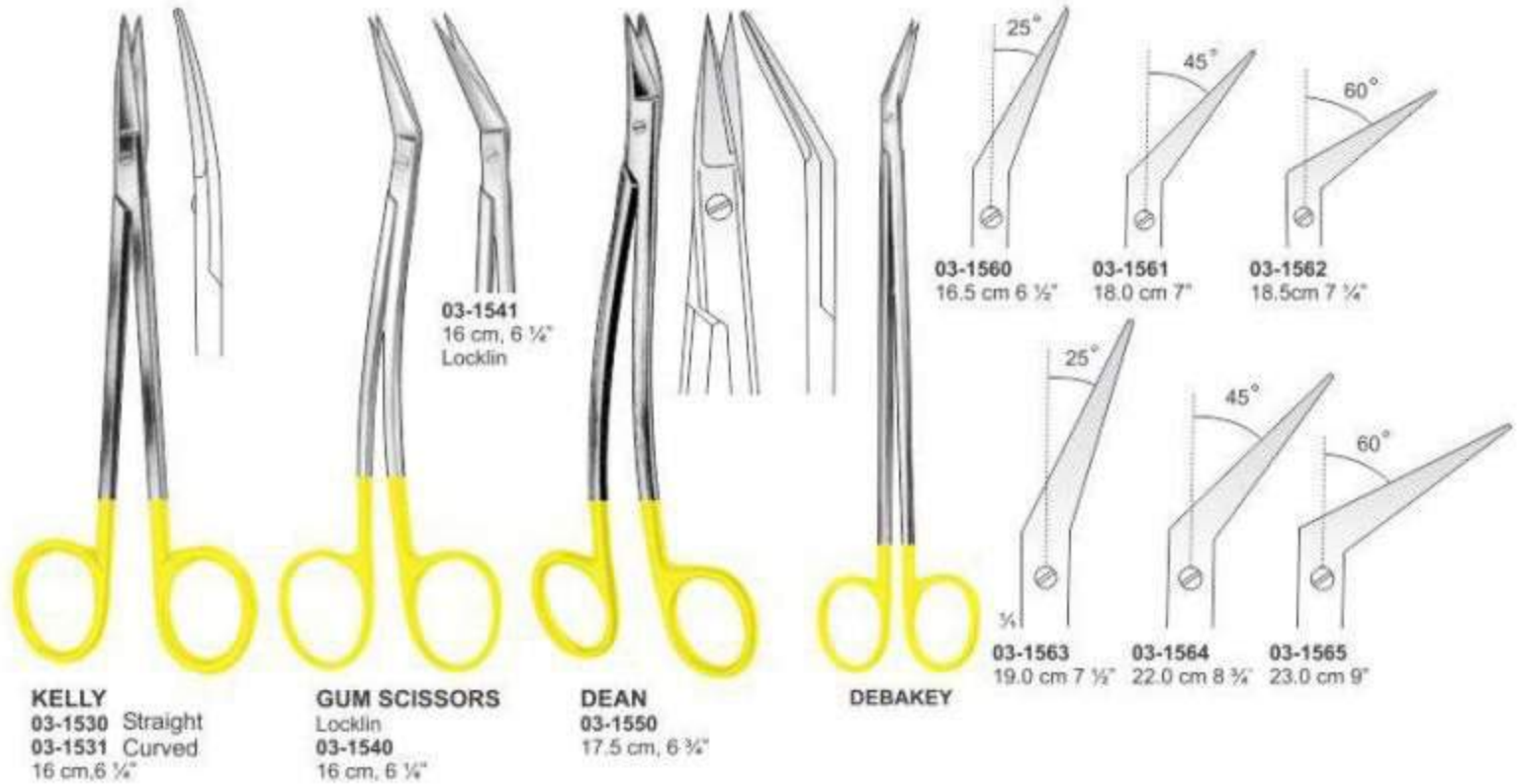

DRESSING & TISSUE FORCEPS

Anatomische pinzetten, Pincas a tissu
Pinzas de disección, Gewebe

Pincas à dissection, Pinzas para tejidos
Pinze per dissezione, Pinze per tessuti

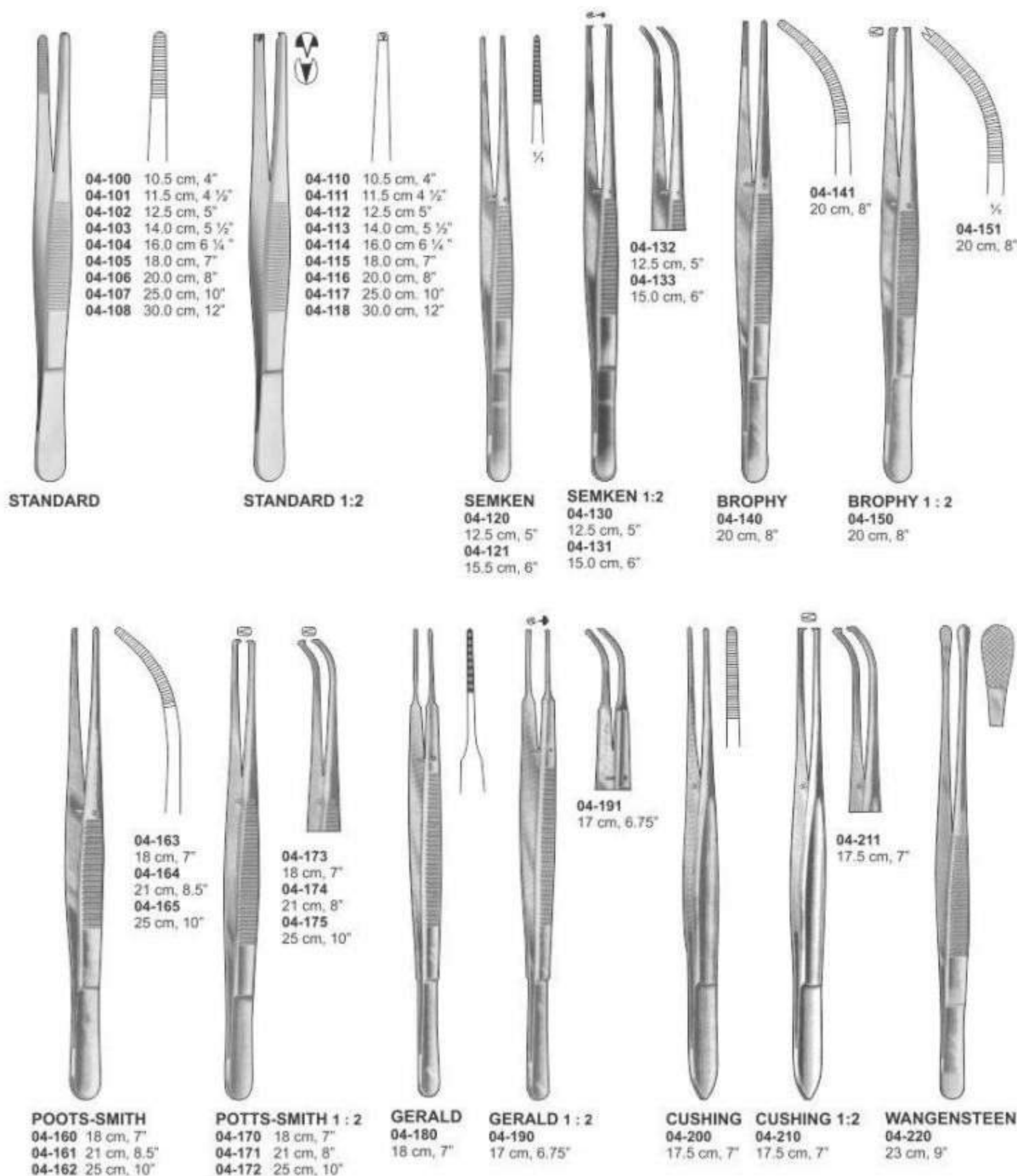

TISSUE & DRESSING FORCEPS

*Pincas a tissu, Anatomische pinzetten
Gewebe, Pinzas de disección*

*Pinzas para tejidos, Pincas à dissection
Pinze per tessuti, Pinze per dissezione*



TAYLOR 1:2
04-230
17.5 cm, 7"



GILLIES 1:2
04-240
15 cm, 6"



04-250 11.5 cm 4 1/2"
04-251 13.0 cm 5"
04-252 14.5 cm 5 1/2"
04-253 16.0 cm 6 1/4"
04-254 18.0 cm 7"
04-255 20.0 cm 8"
04-256 25.0 cm 10"
04-257 30.0 cm 12"



04-260
13 cm, 5"
04-261
14.5 cm, 5 1/2"
04-262
16 cm, 6 1/4"



04-270
13 cm, 5"
04-271
14.5 cm, 5 1/2"
04-272
16 cm, 6 1/4"



STILLE 1:2
04-280
15 cm, 6"



STILLE 2:3
04-290
15 cm, 6"



MCINDOE
04-300 15.0 cm, 6"
Dissecting Forceps
non-toothed,
serrated jaws.



JEAN 1:2
04-310 14.0 cm, 5 1/2"
04-311 18.0 cm, 7"
Dissecting Forceps
one into two teeth on
serrated jaws.



TREVES 1:2
04-320 12.5 cm, 5"
04-321 15.0 cm, 6"
04-322 18.0 cm, 7"
Dissecting Forceps
teeth, on smooth jaws.



RAMSAY 1:2
04-330 18.0 cm, 7"
Dissecting Forceps
one into teeth on
serrated jaws.
As above but into
three teeth.



04-340 12.5 cm, 5"
04-341 15.0 cm, 6"
04-342 18.0 cm, 7"
Dissecting Forceps
turn over end,
serrated jaws.



FERRIS-SMITH 1:2
04-350
18 cm, 7"

TISSUE & DRESSING FORCEPS

*Pinces a tissu, Anatomische pinzetten
Gewebe, Pinzas de disección*

*Pinzas para tejidos, Pinces à dissection
Pinze per tessuti, Pinze per dissezione*



FERRIS-SMITH 1:2
04-360
18 cm, 7"



LANE 1:2
04-370 12.5cm, 5 1/2"
04-371 15 cm, 6"
04-372 17 cm, 6 3/4"
04-373 18 cm, 7"
04-374 20 cm, 8"



BONNEY 1:2
04-390
18 cm, 7"

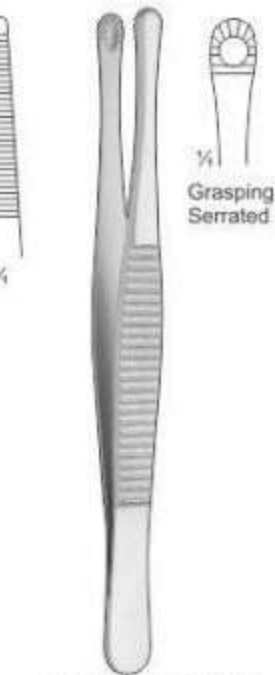

RUSSIAN-MODELL
04-400 15 cm, 5 3/4"
04-401 20 cm, 8"
04-402 25 cm, 10"

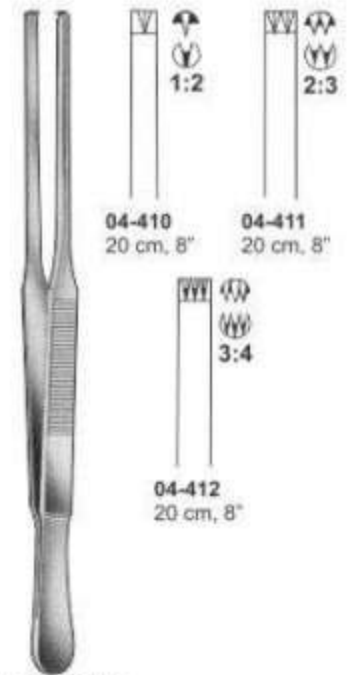

DUEHRSSEN



DUEHRSSEN
04-420
20 cm, 8"



MAYO-RUSSIAN
04-430 15.5cm, 6"
04-431 23.0cm, 9"



Grasping,
serrated.



DAVIS
04-440
25 cm, 10"



COLLIN-DUVAL



04-450 20 cm, 8"
04-451 20 cm, 8"



04-452
20 cm, 8"



YASARGIL-SAMI
Jaws Spoon-Shaped
24 cm, 9 1/4"



04-460 3mm
04-461 5mm
04-462 7mm



LUCAE / ENT



04-470
14 cm, 5 1/2"
Dressing,
Serrated
04-471
16 cm, 6 1/2"
Dressing,
Serrated

TISSUE & DRESSING FORCEPS

*Pinces a tissu, Anatomische pinzetten
Gewebe, Pinzas de disección*

*Pinzas para tejidos, Pinces à dissection
Pinze per tessuti, Pinze per dissezione*

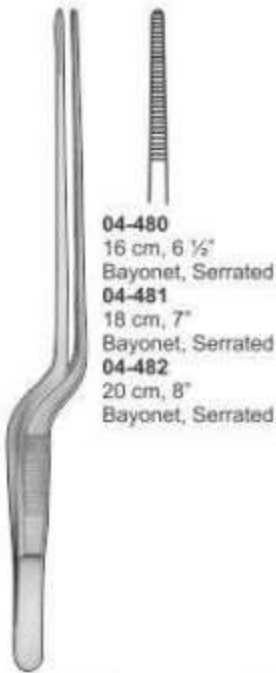

JANSEN-GRUENWALD



ADSON-BROWN

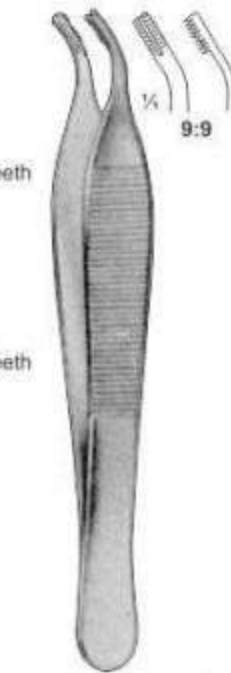

ADSON-BROWN
04-500
12 cm, 5"



BROWN



ADSON / MICRO-ADSON

04-520 12 cm, 5"
dressing, serrated
04-521 12 cm, 5"
dressing, Micro serrated
04-522 12 cm, 5"
dressing, serrated
tungsten carbide

04-525 12 cm, 5"
Tissue, 1:2 Teeth
04-526 12 cm, 5"
Tissue, Micro 1:2 Teeth
04-527 12 cm, 5"
Tissue, 2:3 Teeth

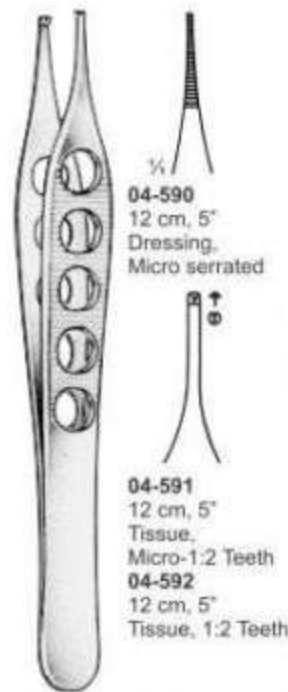

LIGHTWEIGHT-ADSON



DE BAKEY / LIGHTWEIGHT
04-600
16 cm, 6 1/2"



DE BAKEY



MODELL USA



MODELL USA



GILLIES
04-645
15 cm, 6"
1:2 teeth



MCINDOE
04-640
15 cm, 6"

ATRAUMATIC DRESSING, CILIA, SPLINTER FORCEPS

Atraumatische Pinzette, Cilienpinzetten, Splitterpinzetten
Pinza de disección atraumática, Pinzas depilatorias, Pinzas Para espinas

Pince atraumatique à dissection, Pincas à épiler les cils, Pincas à échardes
Pinza atraumatica, Pinze depilatoria, Pinze per scheggie

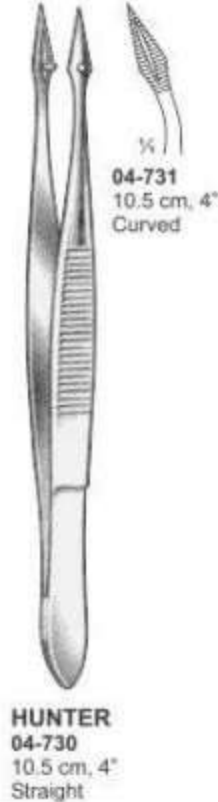
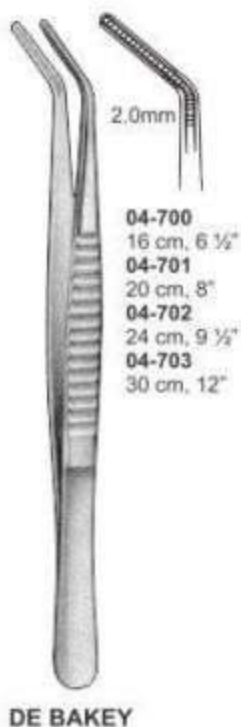
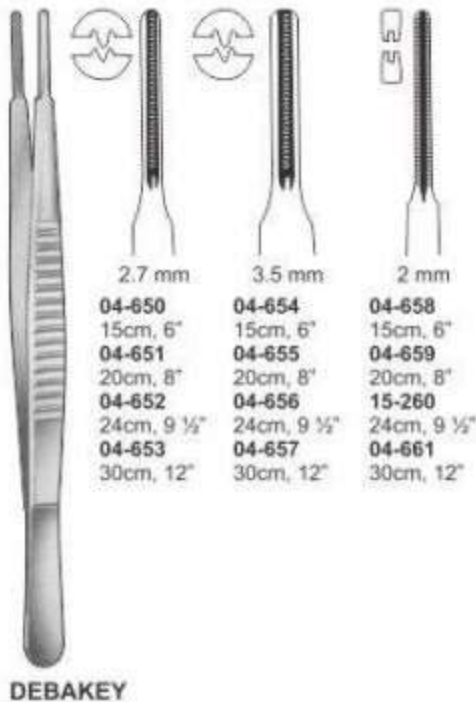

JEWELER TYPE & SPLINTER FORCEPS

Splitterpinzetten
Pinzas Para espinas

Pinces à échardes
Pinze per scheggie

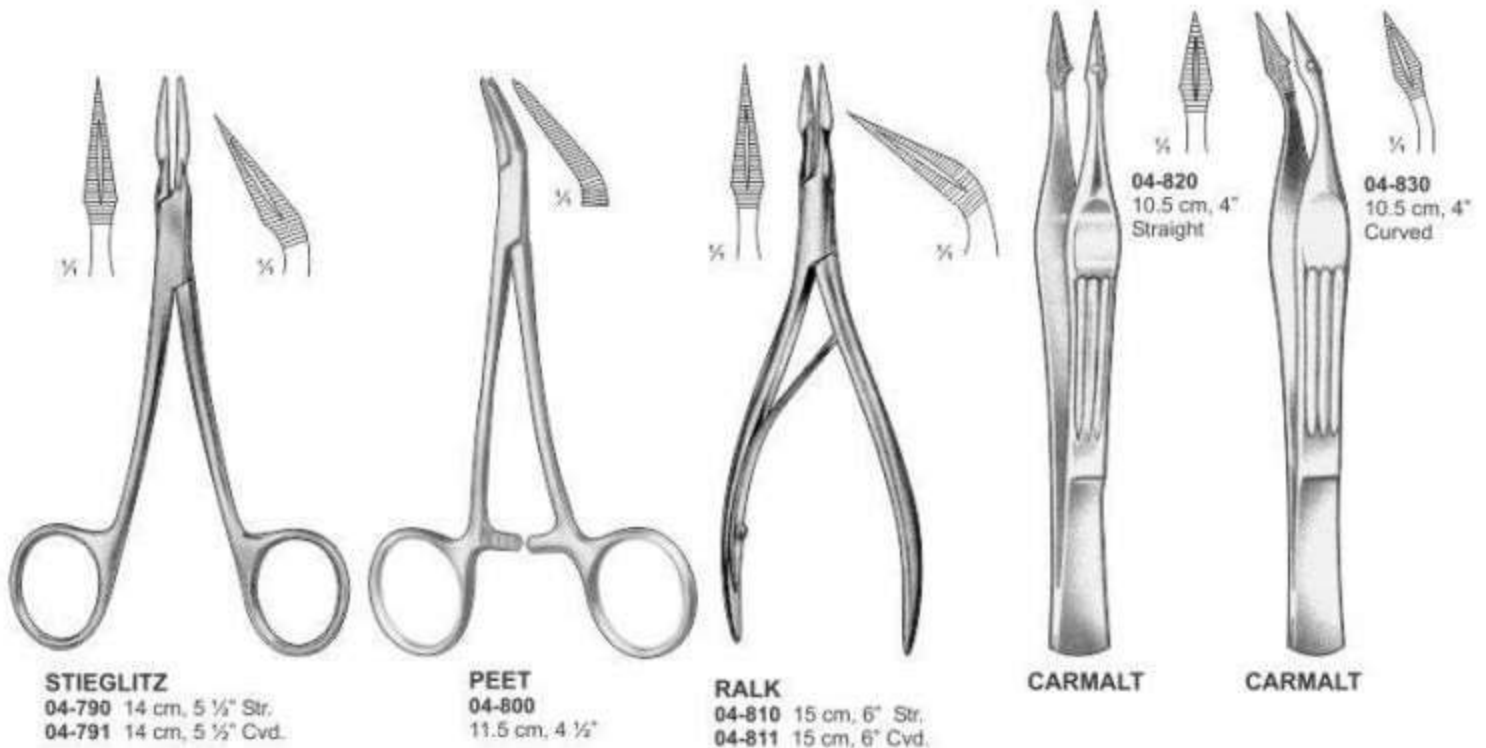
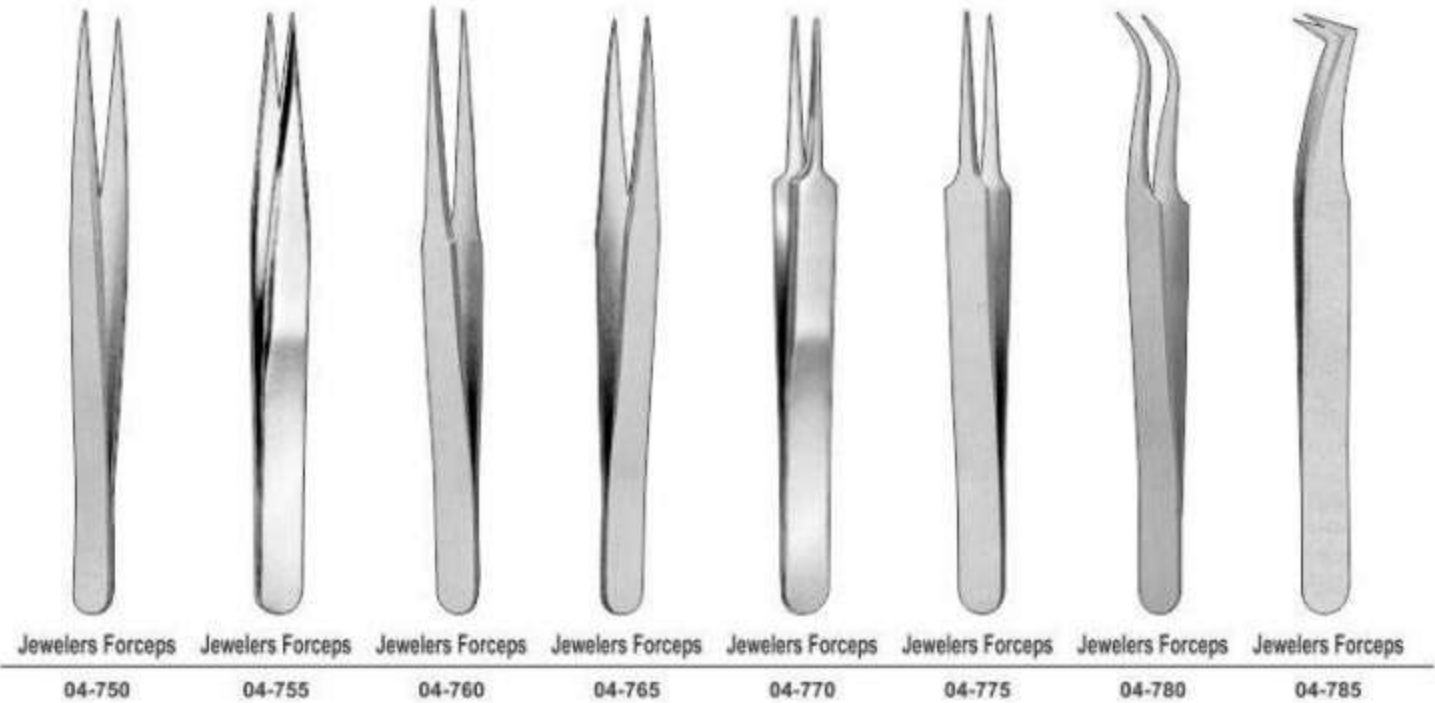

TISSUE & DRESSING FORCEPS T.C

*Pinces a tissu, Anatomische pinzetten
Gewebe, Pinzas de disección*

*Pinzas para tejidos, Pinces à dissection
Pinze per tessuti, Pinze per dissezione*

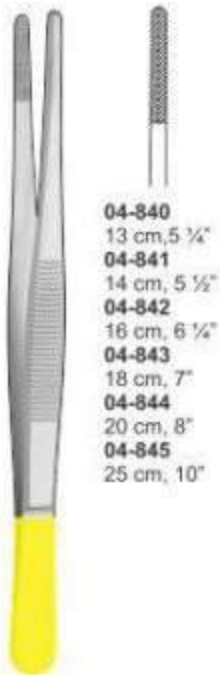

04-840
13 cm, 5 1/4"
04-841
14 cm, 5 1/2"
04-842
16 cm, 6 1/4"
04-843
18 cm, 7"
04-844
20 cm, 8"
04-845
25 cm, 10"

STANDARD



04-850
14 cm, 5 1/2"
04-851
16 cm, 6 1/4"
04-852
18 cm, 7"
04-853
20 cm, 8"
04-854
25 cm, 20"
04-855
30 cm, 12"

STANDARD



04-860
12 cm, 5"
cross serration
04-861
12 cm, 5"
cross serration-1:2 Teeth
04-862
15.0 cm, 6"
cross serration-1:2 Teeth



04-863
12 cm, 5"
Dressing, cross serration
04-864
12 cm, 5"
Tissue, cross serration-1:2 Teeth

ADSON



ADSON
04-870
12 cm, 5"

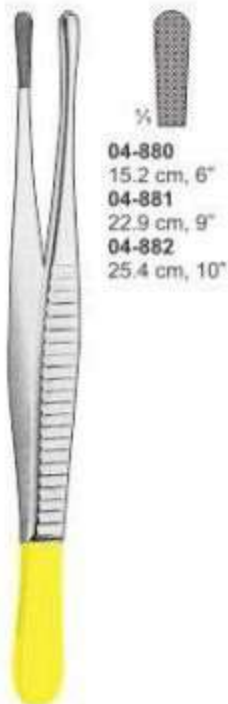

04-880
15.2 cm, 6"
04-881
22.9 cm, 9"
04-882
25.4 cm, 10"

**WANGENSTEEN
TISSUE FORCEPS**



WANGENSTEEN
04-890 15 cm, 6"
04-891 23 cm, 9"
04-892 25 cm, 10"



**BONNEY
DISSECTING**



04-900
18 cm
Straight
X-Serrations
1:2 Teeth



04-901
18 cm
Straight, Serrated-
1:2 Teeth



04-902
18 cm
Straight, Serrated-
2:3 Teeth



**POTTS-SMITH
FORCEPS**
04-910 15 cm, 6"
04-911 18 cm, 7"
04-912 20 cm, 8"
04-913 23 cm, 9"
04-914 25 cm, 10"

HAEMOSTATIC FORCEPS

Arterienklemmen
Pinzas hemostaticas

Pinces hemostatiques
Pinze emostatiche



CARREL
05-100
8.5 cm, 3 1/4"

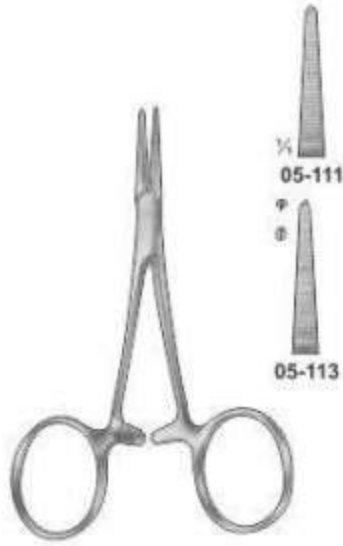

**BABY-MOSQUITO
(HARTMANN)**
05-110
10.0 cm, 4"

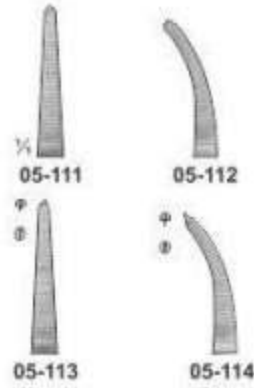

MICRO-HALSTED
05-120
12.5 cm, 5"

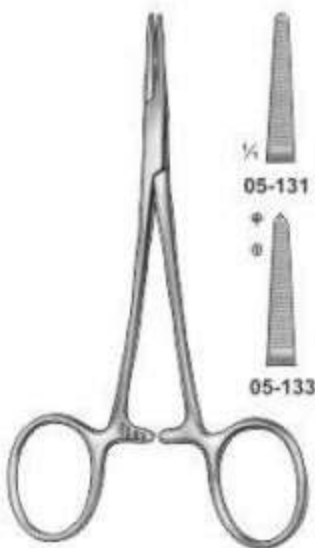
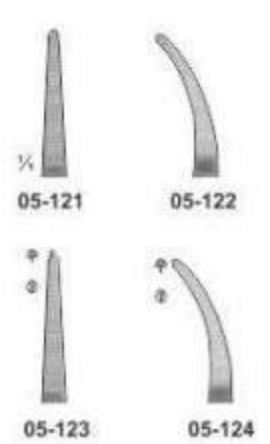

HALSTED-MOSQUITO
05-130
12.5 cm, 5"



PROVIDENCE-HOSPITAL
05-140
14.0 cm, 5 1/2"



KELLY
05-150
14.0 cm, 5 1/2"

HAEMOSTATIC FORCEPS

Arterienklemmen
Pinzas hemostaticas

Pinces hemostatiques
Pinze emostatiche

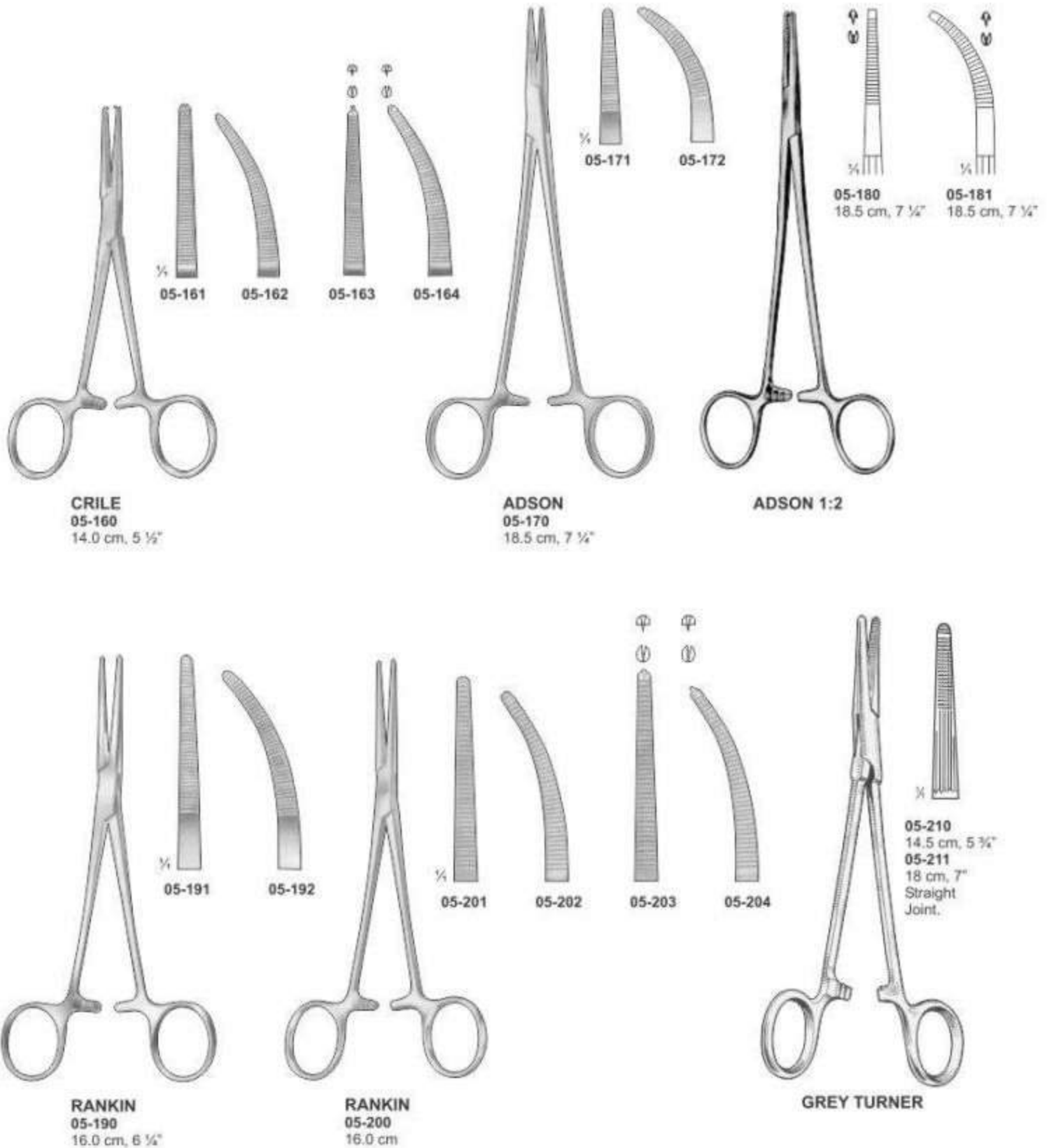

HAEMOSTATIC FORCEPS

Arterienklemmen
Pinzas hemostaticas

Pinces hemostatiques
Pinze emostatiche



CAIRNS
05-220
14.5 cm, 5 3/4"
Straight, box joint, as above but curved on flat.

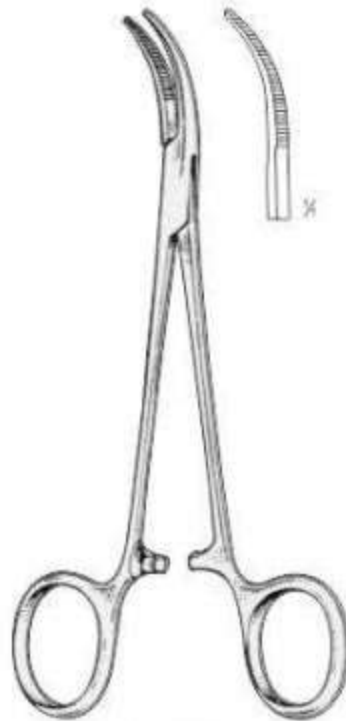

CAIRNS
05-230
14.5 cm, 5 3/4"
curved laterally, joint.



05-240	13.0 cm	05-244	13.0 cm
05-241	15.0 cm	05-245	15.0 cm
05-242	17.5 cm	05-246	17.5 cm
05-243	20 cm	05-247	20 cm

SPENCER-WELLS
Slender Type



PEAN

05-260	24cm, 9 3/4"	05-263	24cm, 9 3/4"
05-261	26cm, 10 1/4"	05-264	26cm, 10 1/4"
05-262	28cm, 11"	05-265	28cm, 11"

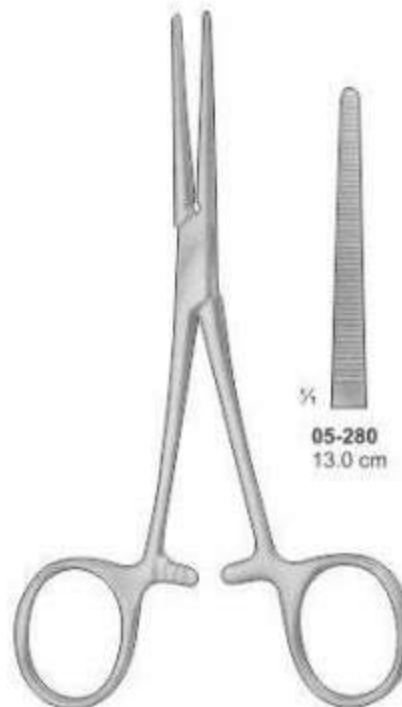

PEAN
Slender Type

05-280	13.0 cm	05-281	14.0 cm	05-282	13.0 cm	05-283	14.0 cm
--------	---------	--------	---------	--------	---------	--------	---------

HAEMOSTATIC FORCEPS

Arterienklemmen
Pinzas hemostaticas

Pinces hemostatiques
Pinze emostatiche



ROCHESTER-PEAN

05-310 16cm, 6 1/4"
05-311 18.5cm, 7 1/4"
05-312 20cm, 8"
05-313 22.5cm, 9"
05-314 24.0cm, 9 3/4"
05-315 26cm, 10 1/4"



05-316 16cm, 6 1/4"
05-317 18.5cm, 7 1/4"
05-318 20cm, 8"
05-319 22.5cm, 9"
05-320 24.0cm, 9 3/4"
05-321 26cm, 10 1/4"



KOCHER-OCHSNER



05-290 16cm, 6 1/4"
05-291 18.5cm, 7 1/4"
05-292 20cm, 8"
05-293 22.5cm, 9"
05-294 24.0cm, 9 3/4"
05-295 26cm, 10 1/4"



05-296 16cm, 6 1/4"
05-297 18.5cm, 7 1/4"
05-298 20cm, 8"
05-299 22.5cm, 9"
05-300 24.0cm, 9 3/4"
05-301 26cm, 10 1/4"

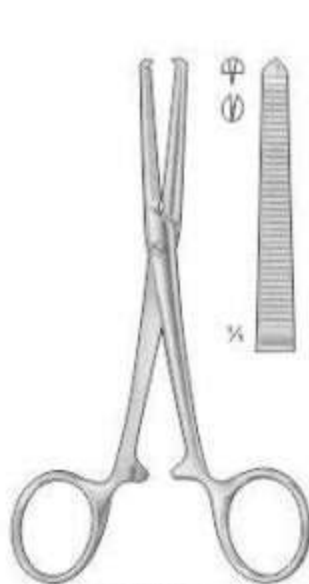

KOCHER
Strong Pattern
05-330
14.5cm, 5 3/4"

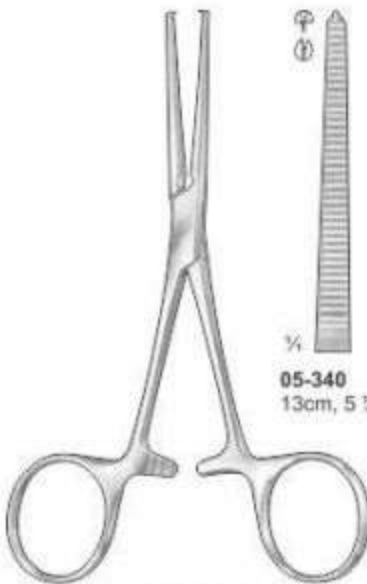

KOCHER

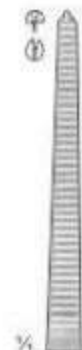

05-340
13cm, 5 1/4"

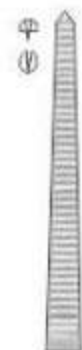

05-341
14cm, 5 3/8"



05-342
14cm, 5 3/8"

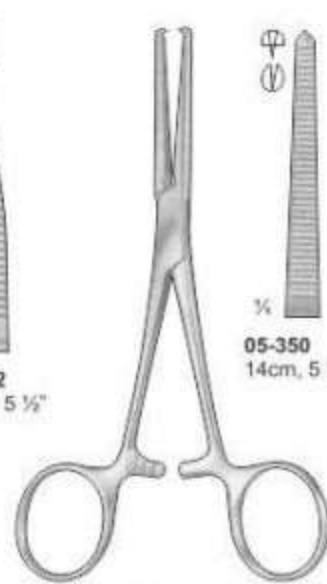

ROCHESTER-OCHSNER



05-350
14cm, 5 3/8"



05-351
14cm, 5 3/8"

HAEMOSTATIC FORCEPS

Arterienklemmen
Pinzas hemostaticas

Pinces hemostatiques
Pinze emostatiche

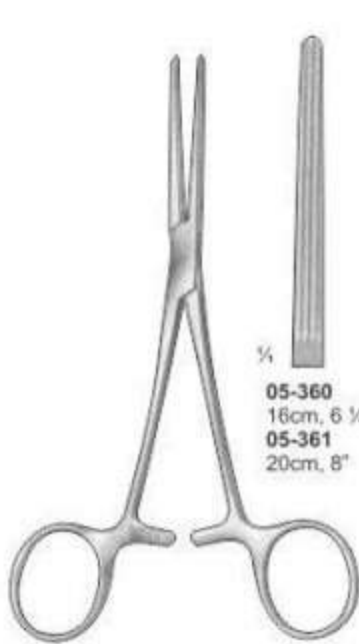

1/4
05-360
16cm, 6 1/4"
05-361
20cm, 8"

05-362
16cm, 6 1/4"
05-363
20cm, 8"

ROCHESTER-CARMALT

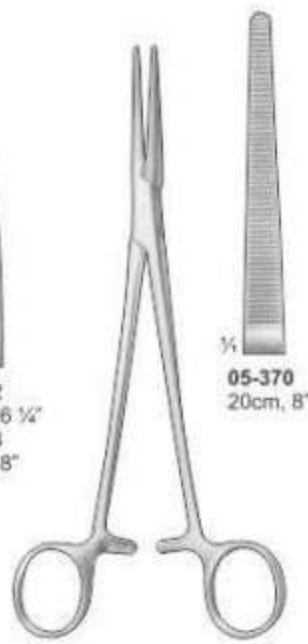

1/4
05-370
20cm, 8"

05-371
20cm, 8"

05-372
20cm, 8"

HEISS

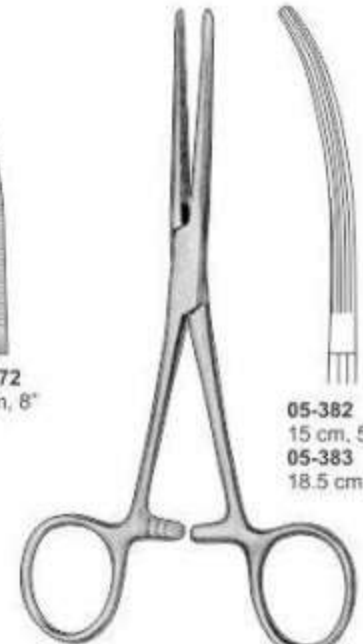

05-382
15 cm, 5 3/4"
05-383
18.5 cm, 7 1/4"

BAINBRIDGE

05-380 15 cm, 5 3/4"
05-381 18.5 cm, 7 1/4"



1/4
05-390
24cm, 9 1/2"

05-391
24cm, 9 1/2"

05-392
24cm, 9 1/2"

05-393
24cm, 9 1/2"

05-394
24cm, 9 1/2"

RUMEL

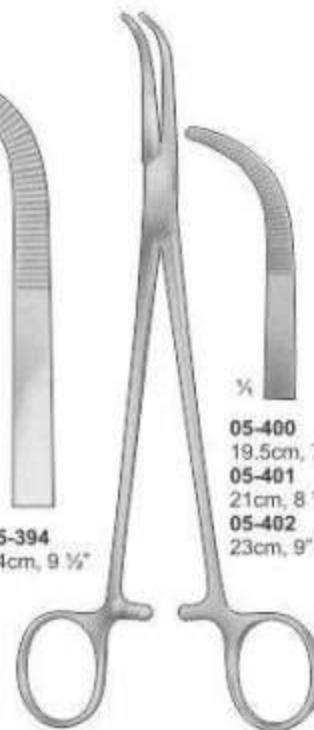

1/4
05-400
19.5cm, 7 3/4"
05-401
21cm, 8 1/4"
05-402
23cm, 9"

05-403
21cm, 8 1/4"
05-404
22cm, 8 3/4"

05-405
22.5cm, 9"

05-406
22.5cm, 9"

05-407
26cm, 10 1/4"

05-408
27cm, 10 1/2"

05-409
27.5cm, 10 3/4"

05-410
27cm, 10 1/4"

05-411
28cm, 11"

OVERHOLT-GEISSENDOERFER

HAEMOSTATIC FORCEPS

Arterienklemmen
Pinzas hemostaticas

Pinces hemostatiques
Pinze emostatiche



MIXTER
05-420
23cm, 9"



LOWER

05-430
18cm, 7"



LAHEY (SWEET)

1/4
05-440
19cm, 7 1/2"
05-441
22cm, 8 3/4"

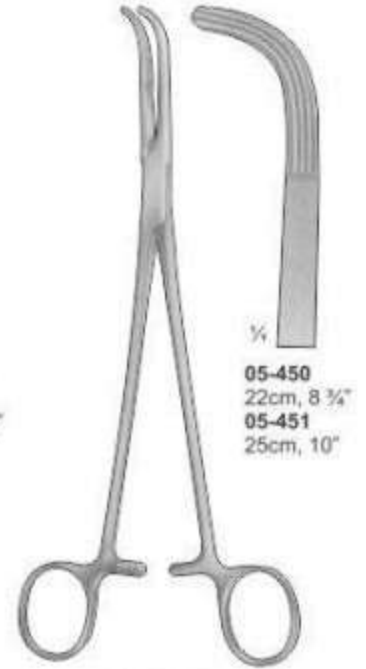

MIXTER

1/4
05-450
22cm, 8 3/4"
05-451
25cm, 10"



DESJARDINS

1/4
05-460
22cm, 8 3/4"

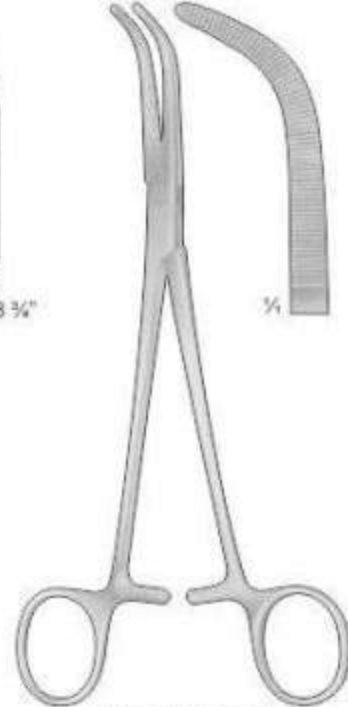

MIXTER-O'SHAUGHNESSY
05-470
19cm, 7 1/2"

1/4



FINOCHIETTO
05-480
24.5cm, 9 3/4"

1/4

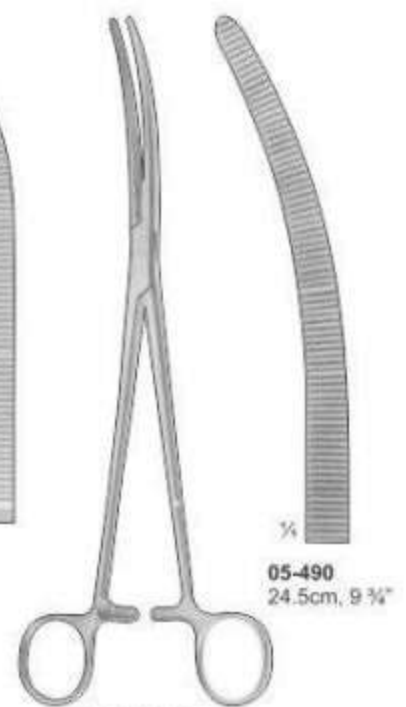

CRAFOORD

1/4
05-490
24.5cm, 9 3/4"

HAEMOSTATIC FORCEPS

Arterienklemmen
Pinzas hemostaticas

Pinces hemostatiques
Pinze emostatiche

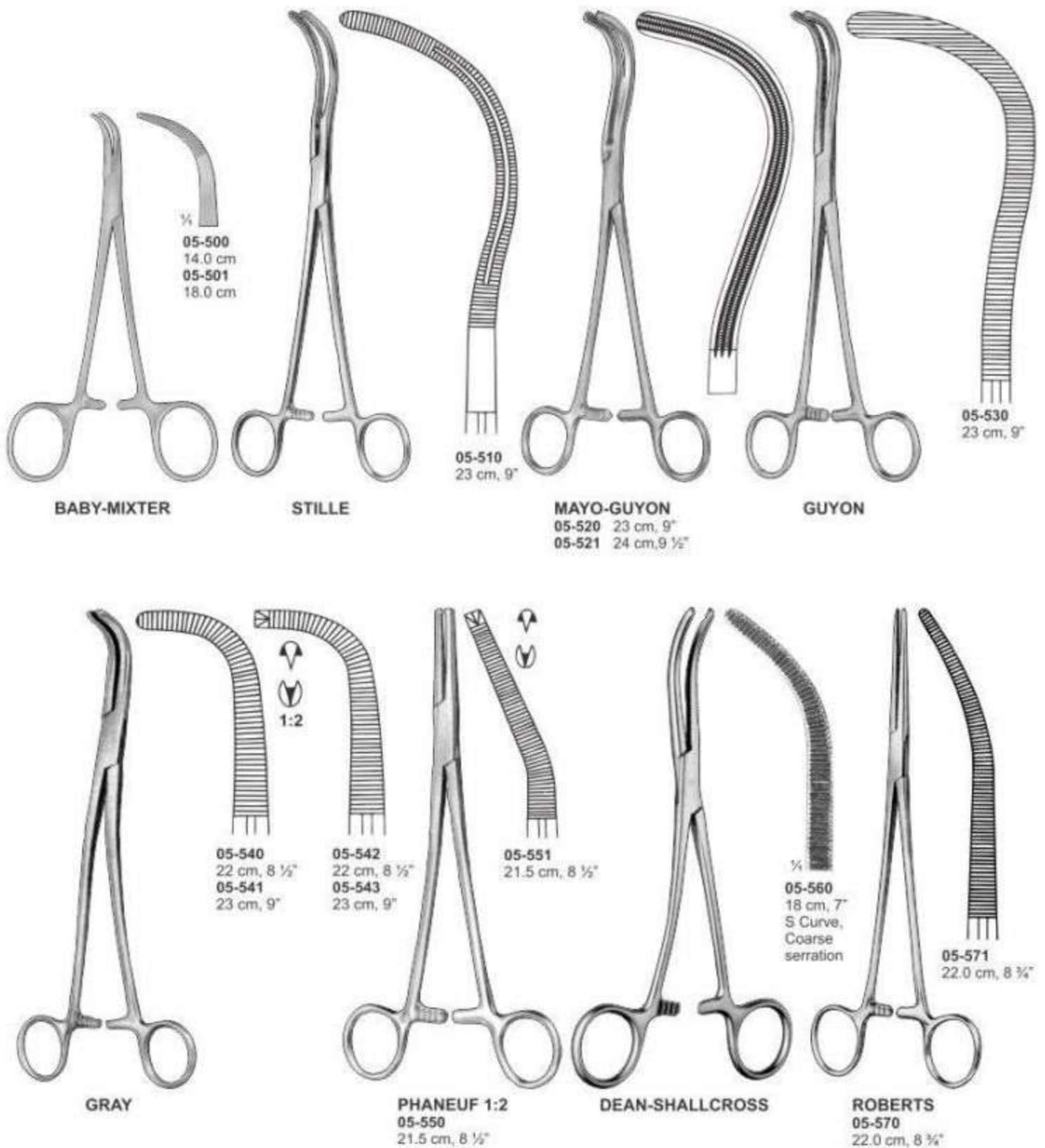

HAEMOSTATIC FORCEPS

Arterienklemmen
Pinzas hemostaticas

Pinces hemostatiques
Pinze emostatiche

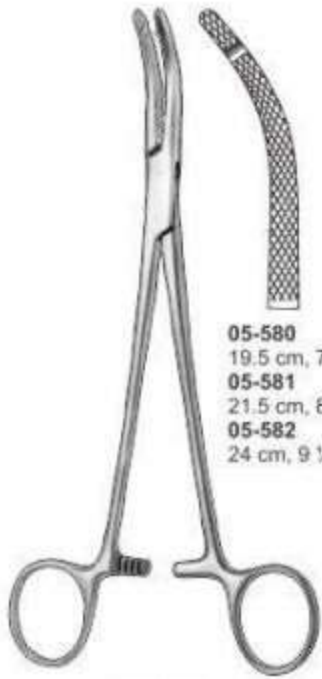

HEANEY

05-580
19.5 cm, 7 1/2"
05-581
21.5 cm, 8 1/2"
05-582
24 cm, 9 1/2"



05-583
19.5 cm, 7 1/2"
05-584
21.5 cm, 8 1/2"
05-585
24 cm, 9 1/2"

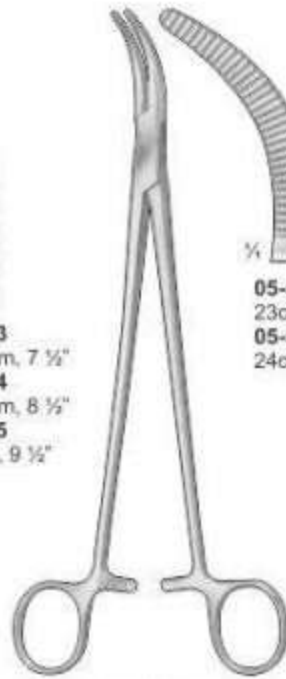

MOYNIHAN

1/4
05-590
23cm, 9"
05-591
24cm, 9 1/4"

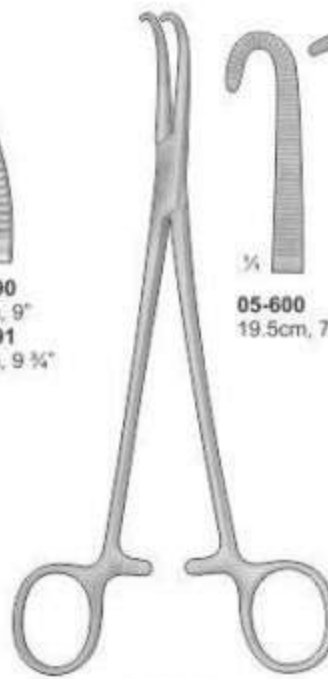

NEGUS

1/4
05-600
19.5cm, 7 1/4"
05-601
19.5cm, 7 3/4"



WERTHEIM-CULLEN

05-610 60mm
05-611 80mm
23cm, 9"



WERTHEIM
05-620
25cm, 10"

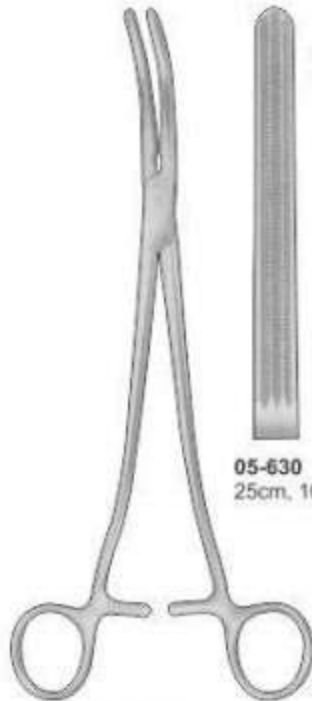

WERTHEIM
Parametrium Clamps

05-630
25cm, 10"



05-631
24.5cm, 9 3/4"



05-632
24cm, 9 1/2"

05-633
22cm, 8 3/4"

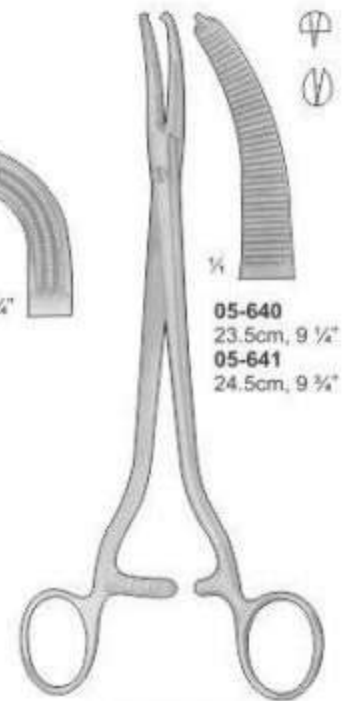

WERTHEIM

1/4
05-640
23.5cm, 9 1/4"
05-641
24.5cm, 9 3/4"

HAEMOSTATIC FORCEPS, TUBING CLAMPS

Arterienklemmen, Schlauchklemmen
Pinzas hemostaticas, Pinzas para tubos

Pinces hemostatiques, Pinces presse-Tubes
Pinze emostatiche, Pinze serratubi

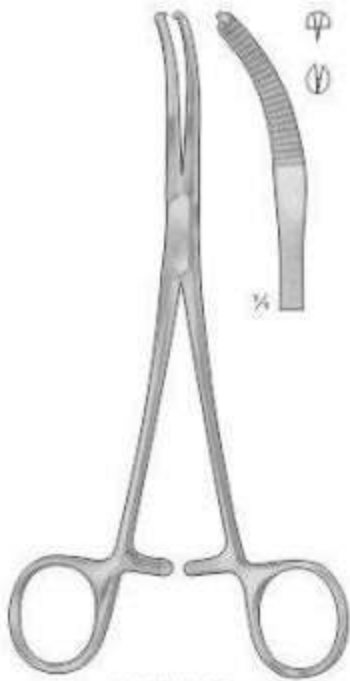

MIKULICZ
05-650
18.5cm, 7 1/4"



MIKULICZ
05-660
20.5cm, 8"

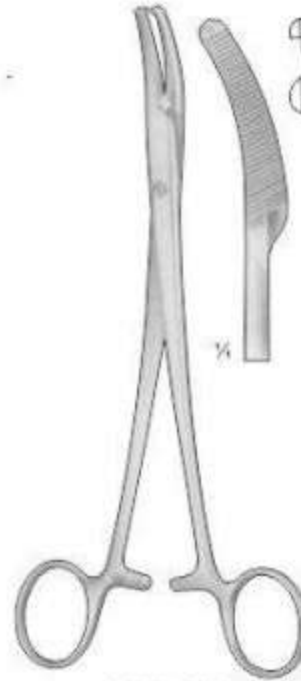

MIKULICZ
05-670
20cm, 8"



MIKULICZ
05-680
20.5cm, 8"

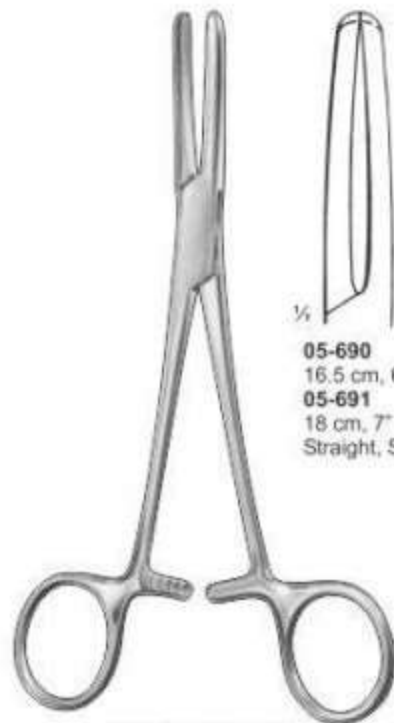

05-690
16.5 cm, 6 1/2"
05-691
18 cm, 7"
Straight, Smooth

PRESBYTERIAN

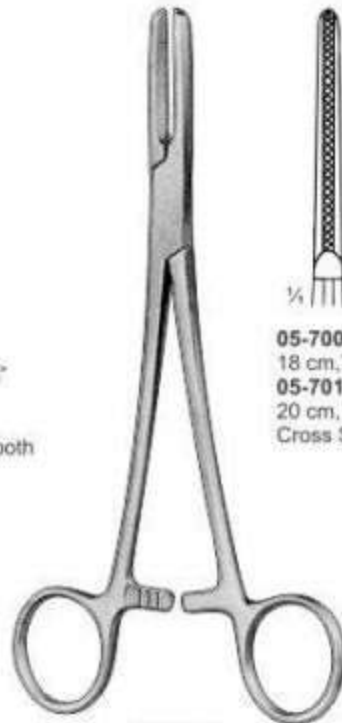

05-700
18 cm, 7"
05-701
20 cm, 8"
Cross Serrated

TUBING

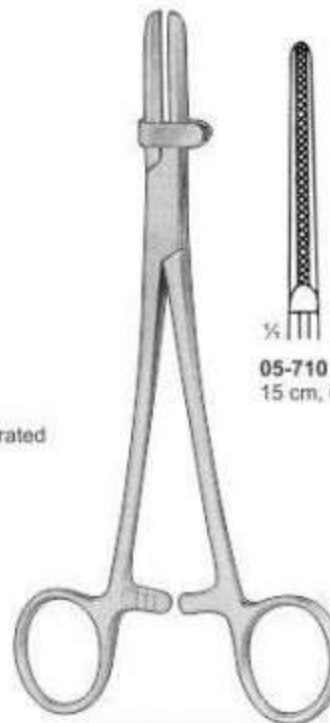

05-710
15 cm, 6"

05-711
18 cm, 7"

05-712
20 cm, 8"

TUBING CLUMP
with Protector,
Cross Serrated

TOWEL FORCEPS

Tuchklemmen
Pinzas de campo

Pinces à champs
Pinze fissatele



**JONES /
PERFORATING**
05-720
9 cm, 3 1/2"
Slight Curve



ENGL. MODELL
05-730
9 cm, 3 1/2"



SCHAEDEL
05-740
9 cm, 3 1/2"



DOYEN
05-750
18 cm, 7"



BACKHAUS
05-760 8 cm, 3"
05-761 11 cm, 4 1/2"
05-762 13 cm, 5"
05-763 15 cm, 5 1/2"
Curved



ROEDER
05-770 13 cm, 5"
05-771 15 cm, 6"
Curved, Serrated

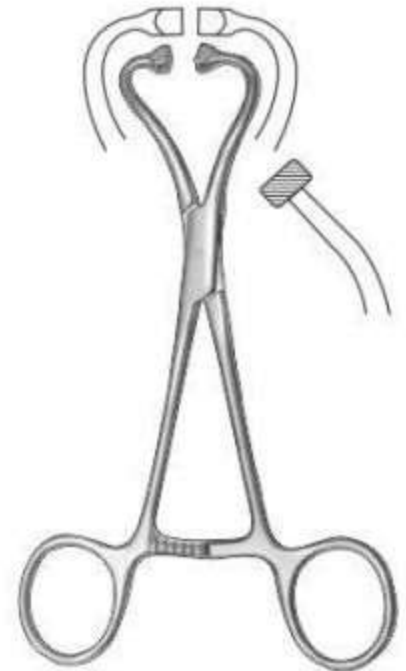

NON-PERFORATING
05-780 11 cm, 4 1/2"
05-781 13 cm, 5"

TOWEL FORCEPS

Tuchklemmen
Pinzas de campo

Pinces à champs
Pinze fissatele

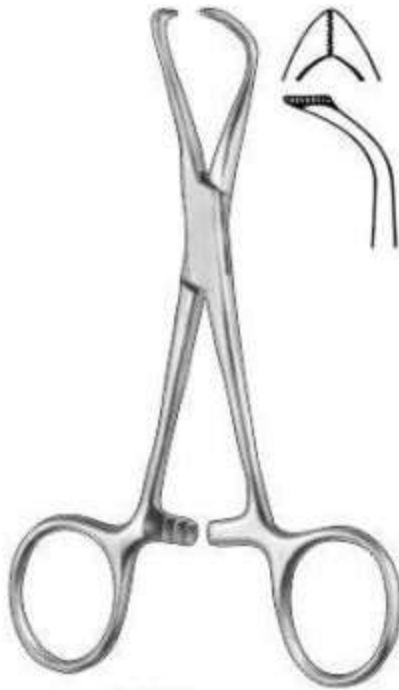

LORNA
05-790 10 cm, 4"
05-791 11 cm, 4 1/2"
05-792 13 cm, 5"



BACKHAUS CLIP
05-800 11 cm, 4 1/2"
with clip for tubing or
cable



BALL & SOCKET
05-810 13 cm, 5"
Non-perforating

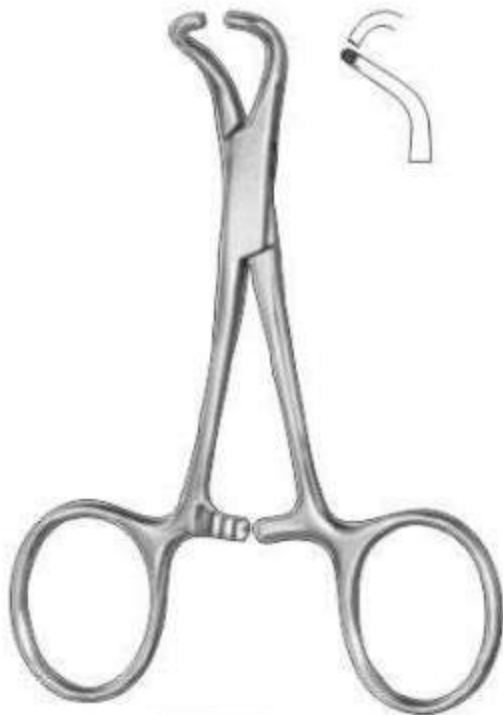

TOHOKU
05-820 10cm, 4"
05-821 13cm, 5"
Non-Perforating

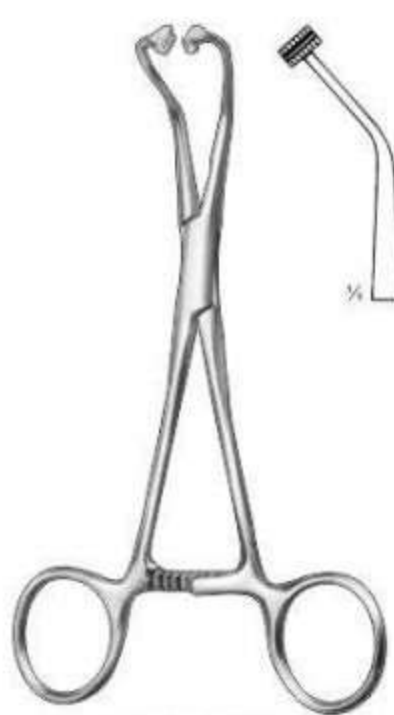

PEERS-BERTMAN
05-830
14.5 cm, 5 1/2"
Serrated



BERNHARD
05-840
16.5 cm, 6 1/2"

HAEMOSTATIC FORCEPS

Arterienklemmen
Pinzas hemostaticas

Pinces hemostatiques
Pinze emostatiche



05-870 05-871 05-872
13cm 15.5cm 17.5cm
5 1/4" 6" 7"

FRICKE
Artery Forceps
05-850
13cm, 5 1/4"

BRYANT
05-860
13cm, 5 1/4"

LISTER
Sinus Forceps

KRONLENIN
05-880
13cm, 5 1/4"

PEAN
05-890
12.5cm, 4 1/4"



05-900 05-901
12.5cm, 4 1/4" 14cm, 5 1/2"

05-920 05-921
16.5cm, 6 1/2" 18.5cm, 7 1/4"

PEAN

PEAN
05-910

PEAN

HAEMOSTATIC FORCEPS

Arterienklemmen
Pinzas hemostaticas

Pinces hemostatiques
Pinze emostatiche



TUFFIER
05-930
13.0 cm, 5"

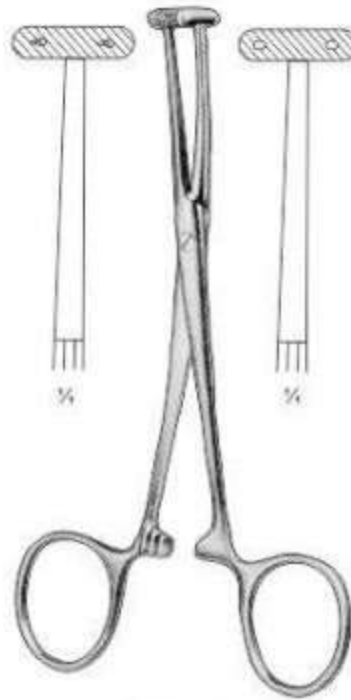

MARTEL
05-940
14.0 cm, 5 1/2"

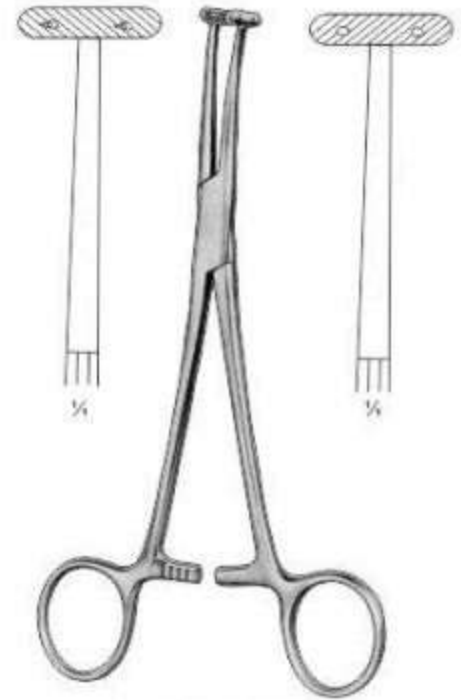

WILLET-MARTEL
05-950
19.0 cm, 7 1/2"



PRATT

05-960
15 cm, 4 3/4"
Slight Curve

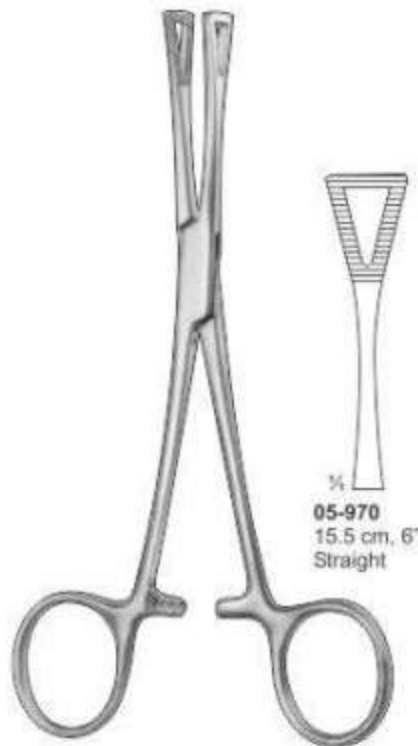

PENNINGTON / SIEZING

05-970
15.5 cm, 6"
Straight



05-971
20 cm, 8"
Straight



CHAPUT
05-980
13.0 cm, 5"

DRESSING FORCEPS

Schwammzange
Pinza para tapones

Pince pour éponges
Pinza per tamponi e sponge

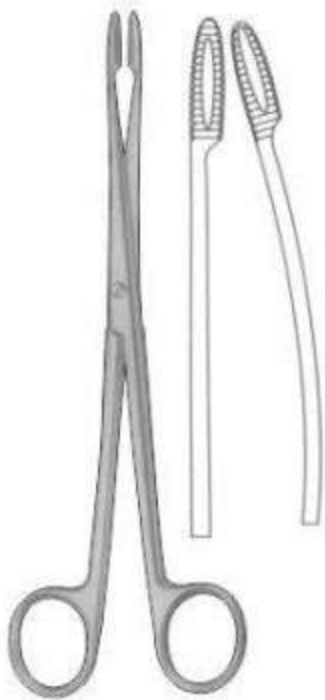

GROSS
05-990 18cm, 7"
05-991 20cm, 8"
With Ratchet

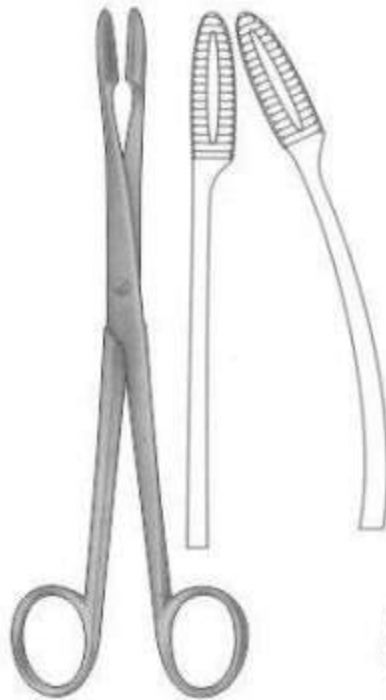

GROSS
Without Ratchet
05-1000
20cm, 8"

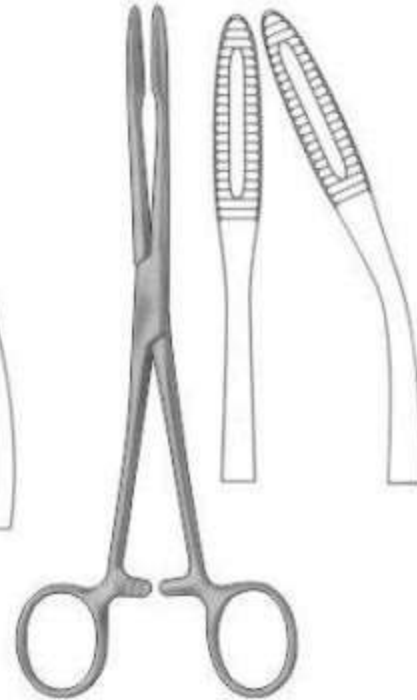

GROSS
With Ratchet
05-1010
20cm, 8"

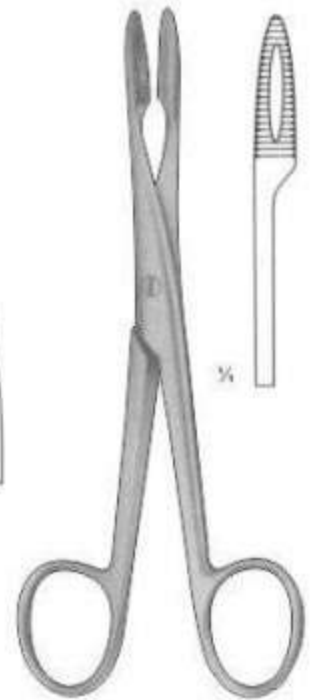

With Ratchet
05-1020
14.5cm, 5 3/4"

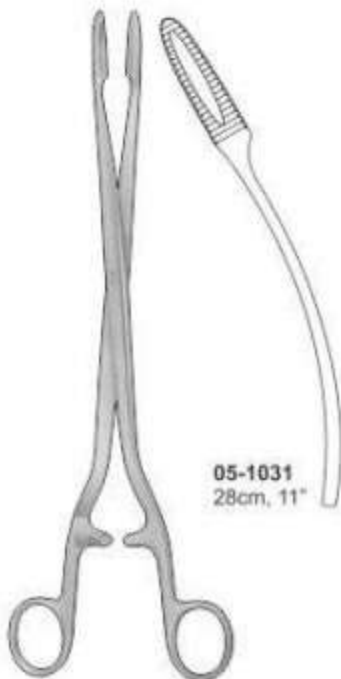

05-1031
28cm, 11"

SIMS-MAIER
05-1030
28cm, 11"



1/4"

COLLIN
05-1040
24cm, 9 1/2"



1/4"

CHERON
Handles Laterally Angled
05-1050
24cm, 9 1/2"

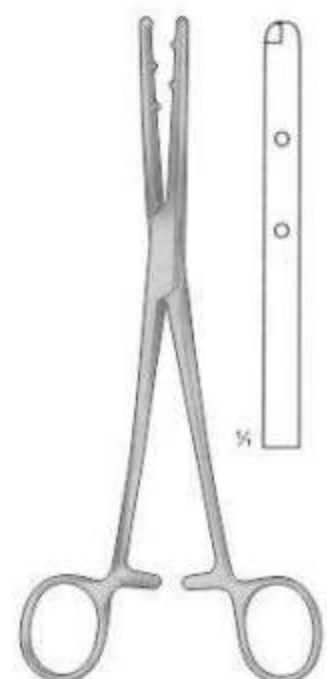

1/4"

EMMET
05-1060
21cm, 8 1/4"

SPONGE FORCEPS

Schwammzange
Pinza para tapones

Pince pour éponges
Pinza per tamponi e sponge

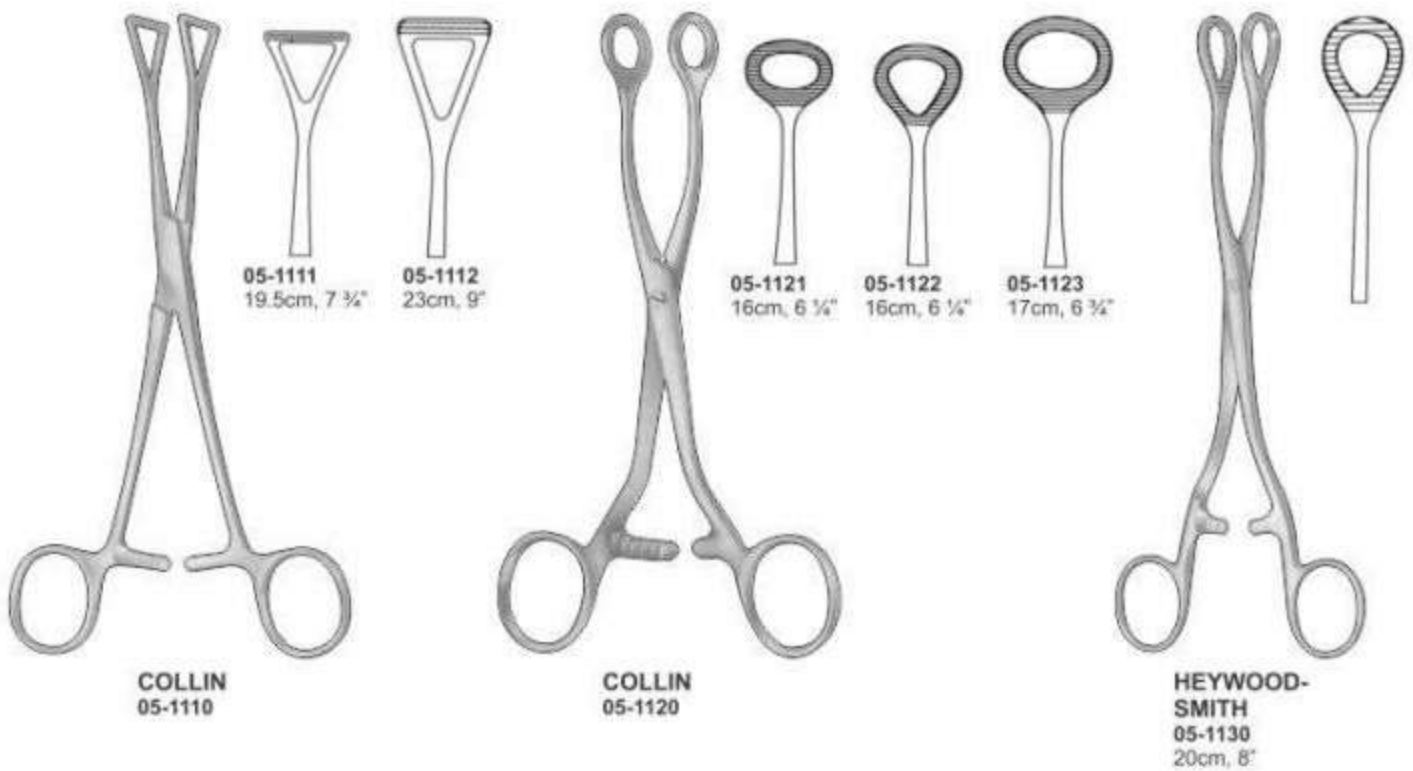
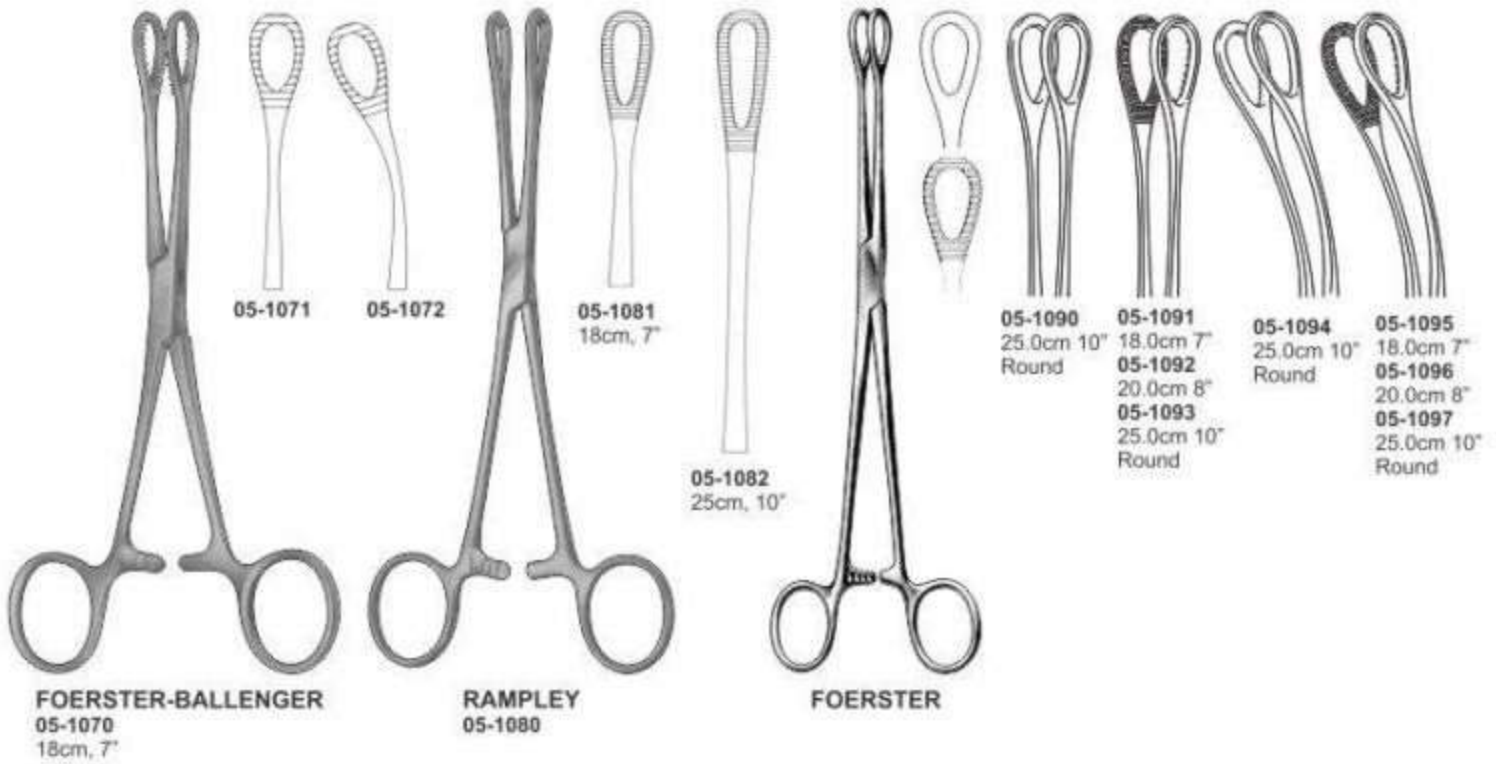

SPONGE & DRESSING FORCEPS

Anatomische pinzetten, Schwammzange
Pinzas de disección, Pinza para taponos

Marteaux-percuteurs, Pince pour éponges
Pinze per dissezione, Pinza per tamponi e spunge

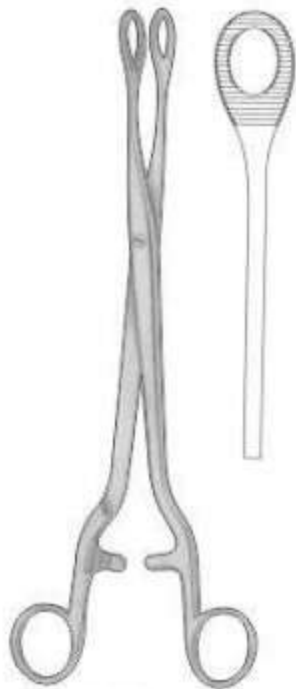

NOTO
05-1140
28cm, 11"



KELLY
05-1150
32Cm, 12 1/2"



ULRICH

05-1160
22 cm, 8 3/4"

05-1161
25 cm, 10"

05-1162
27 cm, 11"

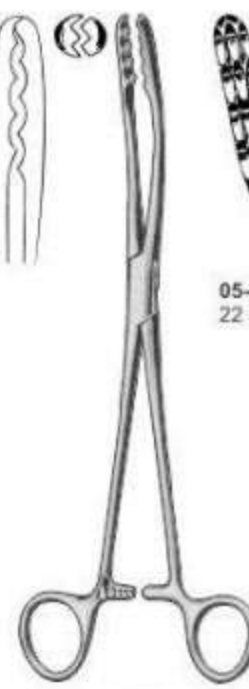

ULRICH

05-1170
22 cm, 8 3/4"

05-1171
25 cm, 10"

05-1172
27 cm, 11"



HEYWOOD SMITH
05-1180
25 cm, 10"



FLETCHER

05-1190
24 cm, 9 1/2"



FLETCHER

05-1200
24 cm, 9 1/2"

NEEDLE HOLDERS

Nadelhalter
Porta-agujas

Porte-agujas
Portaghi

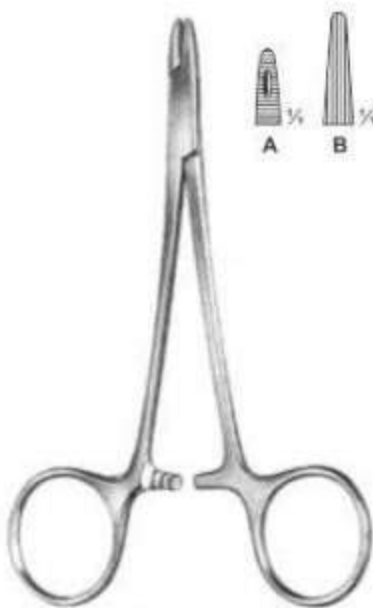

DERF
06-100 12 cm, 5° A
06-101 12 cm, 5° B



COLLIER
06-110 12.5 cm

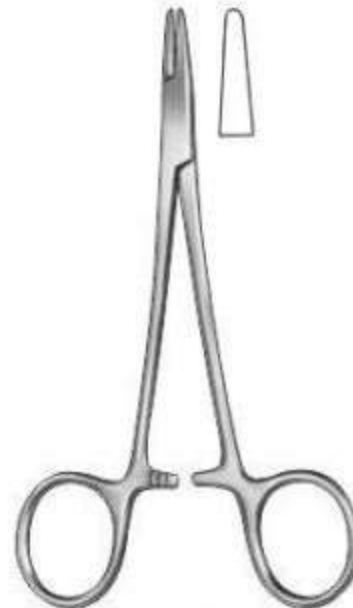

WEBSTER
06-120 13cm



M.G. HOSPITAL

06-125
17.5 cm
Heavy
pattern



MAYO-HEGAR



CRILE-WOOD
06-140 150cm



CRILE-MURRAY
06-150 15 cm

Slender
pattern

NEEDLE HOLDERS

Nadelhalter
Porta-agujas

Porte-agujas
Portaghi



WRIGHT
06-160 13cm



BRUCE-CLARKE
06-170 12.5cm

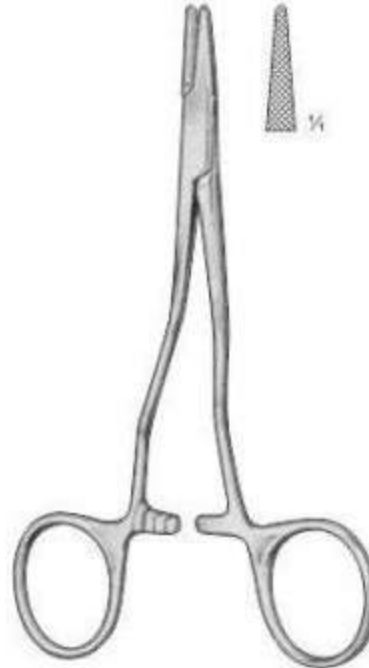

KILNER
06-180 13.5 cm



THOMSON WALKER
06-190 20cm



BOZEMANN
06-200 20cm



METZENBAUM
06-210 18cm



FINOCCHIETTO
06-220 27cm



WANGENSTEEN
06-230 27cm

NEEDLE HOLDERS

Nadelhalter
Porta-agujas

Porte-agujas
Portaghi



MASSON
06-240
27 cm, 10 3/4"



SAROT
06-250
27cm



OLSEN

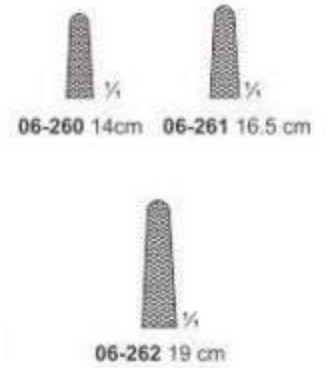

GILLIES
06-270 16 cm



MATHIEU



06-280 11cm
06-281 14cm
06-282 17cm



MATHIEU

06-290 14cm
06-291 17cm
06-292 20cm
06-293 24cm



LANGENBECK
06-300 18.5cm

NEEDLE HOLDERS & LIGATURE NEEDLES

Nadelhalter, Unterbindungsnadeln
Porta-agujas, agujas para ligaduras

Porte-agujas, Aiguilles à ligatures
Portaghi, aghi di legatura



CRILE
06-310
15 cm, 6"



MACPHAIL
06-320 14 cm
06-321 16 cm
06-322 18 cm
06-323 20 cm



HALSTEAD
06-330 16.5cm
06-331 21cm
06-332 24cm

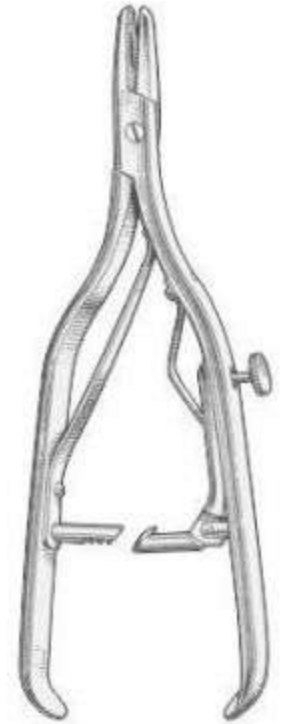

ROCHESTER-MAYO
06-340 18 cm, 8"
06-341 23 cm, 9"
button release, screw joint.



STEVENS
06-350
13cm



KALT-ARRUGA
06-360 14cm



KALT
06-370 14cm



CASTROVIEJO
06-380 14cm



DESCHAMPS
06-390 21cm L
06-391 21cm R



DESCHAMPS
06-400 21cm L
06-401 21cm R

REVERDIN NEEDLES

Reverdin nadeln
agujas de reverdin

Aguilles de reverdin
aghi di reverdin



REVERDIN
15cm



Fig. 1
06-410 14.5cm



Fig. 2
06-411 14.5cm



Fig. 3
06-412 14.5cm



Fig. 4
06-413 14.5cm



06-414



06-415



06-416



REVERDIN
19cm



Fig. 1
06-420



Fig. 2
06-421



Fig. 3
06-422



Fig. 4
06-423



YOUNG BOOMRANG
06-430 25cm

NEEDLE HOLDERS T.C.

Nadelhalter
Porta-agujas

Porte-agujas
Portaghi



06-440
12 cm
Mini profile

DERF



06-451
13 cm
Mini profile

06-452
14.5 cm
Mini profile

HEGAR-BAUMGARTNER
06-450



06-461
13 cm
Smooth jaw

06-462
13 cm
Mini profile

HALSEY
06-460



06-470
12 cm, 13 cm
Two Sizes
Smooth jaw

WEBSTER



06-480
15 cm
Mini profile

CRILE-WOOD







06-490
13 cm
Mini profile

KILNER

NEEDLE HOLDERS T.C.

Nadelhalter
Porta-agujas

Porte-agujas
Portaghi

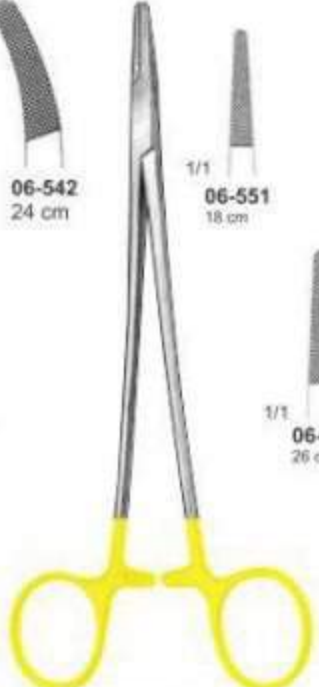
 <p>WEBSTER 06-501 13 cm Mini profile</p> <p>1/1</p> <p>CRILE-WOOD 06-502 15 cm</p> <p>1/1</p> <p>06-510 20.5 cm Mini profile</p> <p>1/1</p> <p>06-521 18 cm Standard profile</p> <p>1/1</p> <p>06-522 20 cm Standard profile</p> <p>1/1</p> <p>06-523 26 cm Standard profile</p> <p>06-500</p>	 <p>06-510 20.5 cm Mini profile</p> <p>1/1</p> <p>06-521 18 cm Standard profile</p> <p>1/1</p> <p>06-522 20 cm Standard profile</p> <p>1/1</p> <p>06-523 26 cm Standard profile</p> <p>CRILE-WOOD</p>	 <p>SAROT 06-520</p>
 <p>MAYO-HEGAR 06-530 Standard profile</p> <p>1/1</p> <p>06-531 16 cm</p> <p>1/1</p> <p>06-532 18 cm</p> <p>1/1</p> <p>06-533 20 cm</p> <p>1/1</p> <p>06-534 24 cm</p> <p>1/1</p> <p>06-535 26 cm</p> <p>1/1</p> <p>06-536 30 cm</p>	 <p>HEANEY 06-540 Standard profile</p> <p>1/1</p> <p>06-541 20 cm</p> <p>06-542 24 cm</p> <p>06-543 26 cm</p>	 <p>DeBAKEY 06-550 Delicate pattern mini profile</p> <p>1/1</p> <p>06-551 18 cm</p> <p>1/1</p> <p>06-552 20 cm</p> <p>1/1</p> <p>06-553 23 cm</p> <p>1/1</p> <p>06-554 26 cm</p> <p>1/1</p> <p>06-555 31 cm</p>

NEEDLE HOLDERS T.C.

Nadelhalter
Porta-agujas

Porte-agujas
Portaghi



RAYDER
06-560
Mini profile

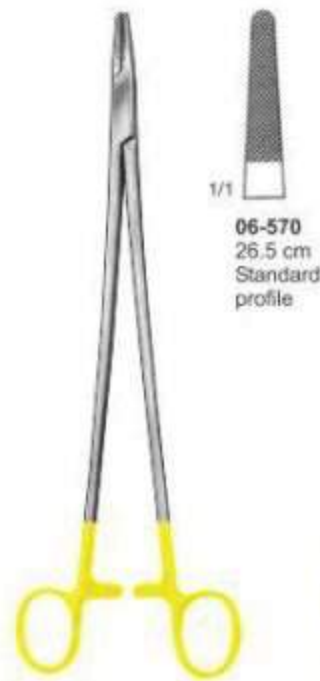

MASSON

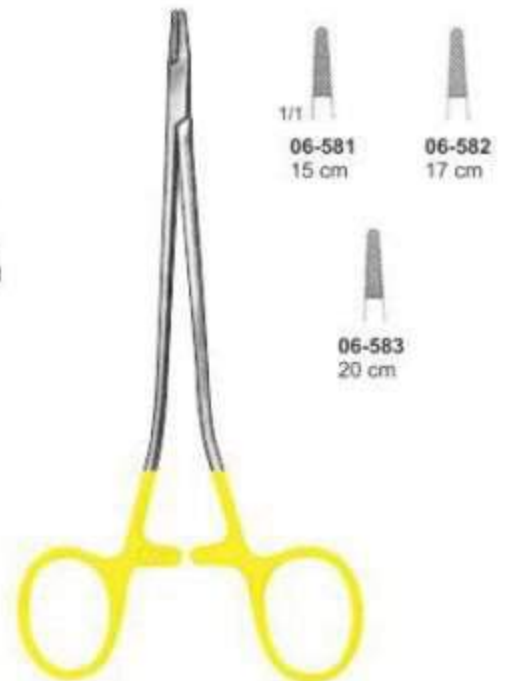

06-580
mini profile
elastic type

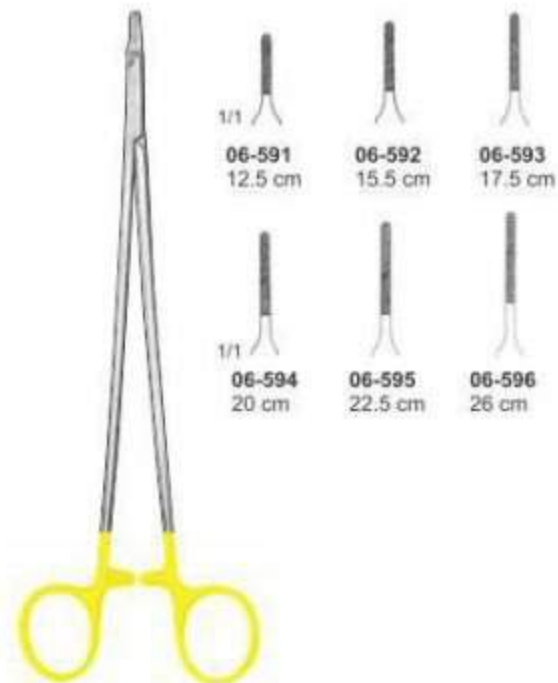

RYDER-VASCULAR
06-590
Slender pattern
micro profile

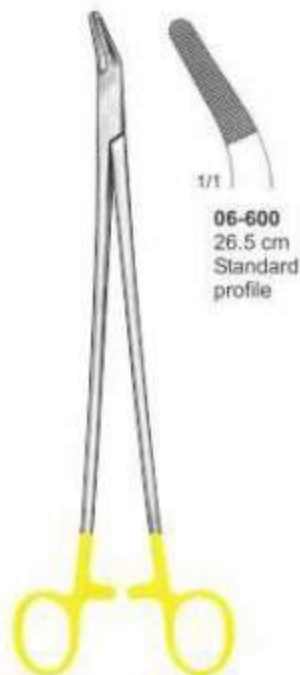

FINOCHIETTO

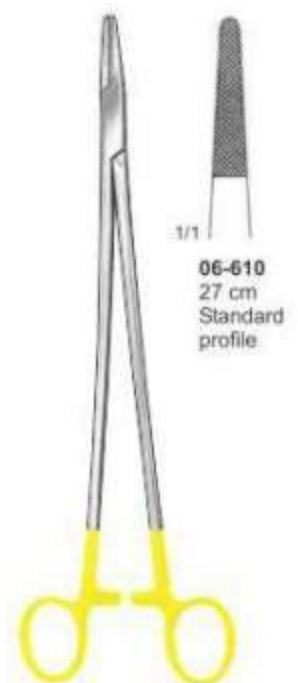

WANGENSTEEN

NEEDLE HOLDERS T.C.

Nadelhalter
Porta-agujas

Porte-agujas
Portaghi



HEGAR-VASCULAR
06-620
Micro profile

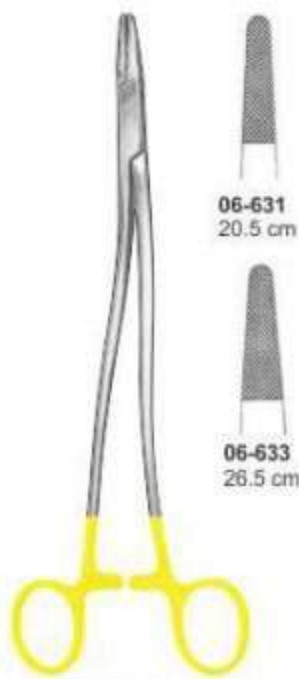

BOZEMANN
06-630
Standard profile



HEGAR
06-640
Standard profile

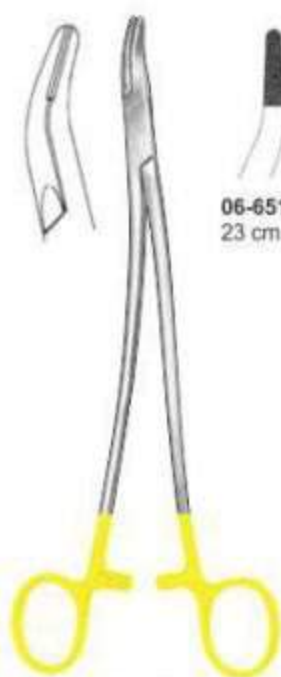

STRATTE
06-650
Standard profile

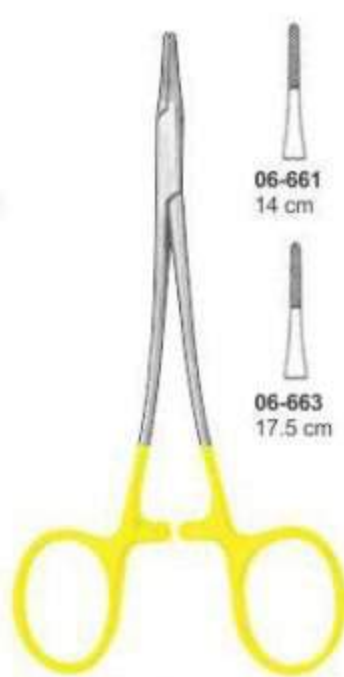

MARTINI
06-660
Slender pattern,
micro profile

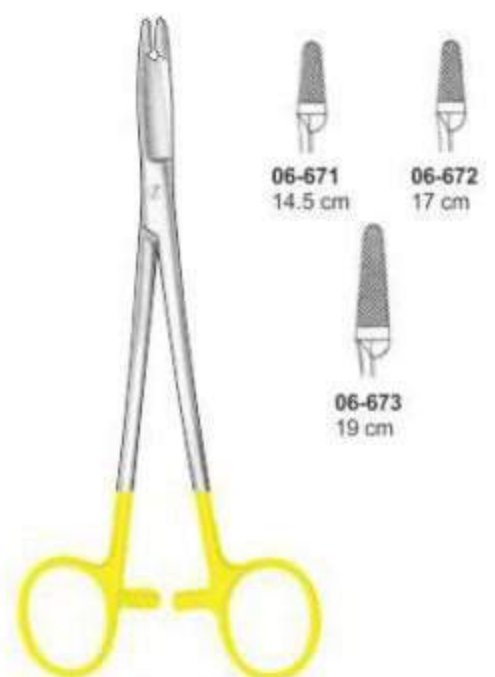

OLSEN-HEGAR
06-670
Standard profile

NEEDLE HOLDERS T.C.

Nadelhalter
Porta-agujas

Porte-agujas
Portaghi



FOSTER-GILLIES



GILLIES-MINI

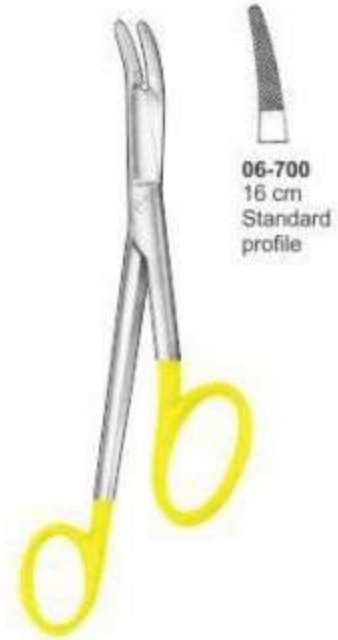

GILLIES



MICROVASCULAR
06-710
Slender pattern,
micro profile



MARTINI
06-720
Slender pattern,
smooth jaw



NEEDLE HOLDERS T.C.

Nadelhalter
Porta-agujas

Porte-agujas
Portaghi



ARRUGA
06-730



CASTROVIEJO



BARRAQUER



BARRAQUER



CASTROVIEJO
06-770



NEEDLE HOLDERS T.C.

Nadelhalter
Porta-agujas

Porte-agujas
Portaghi

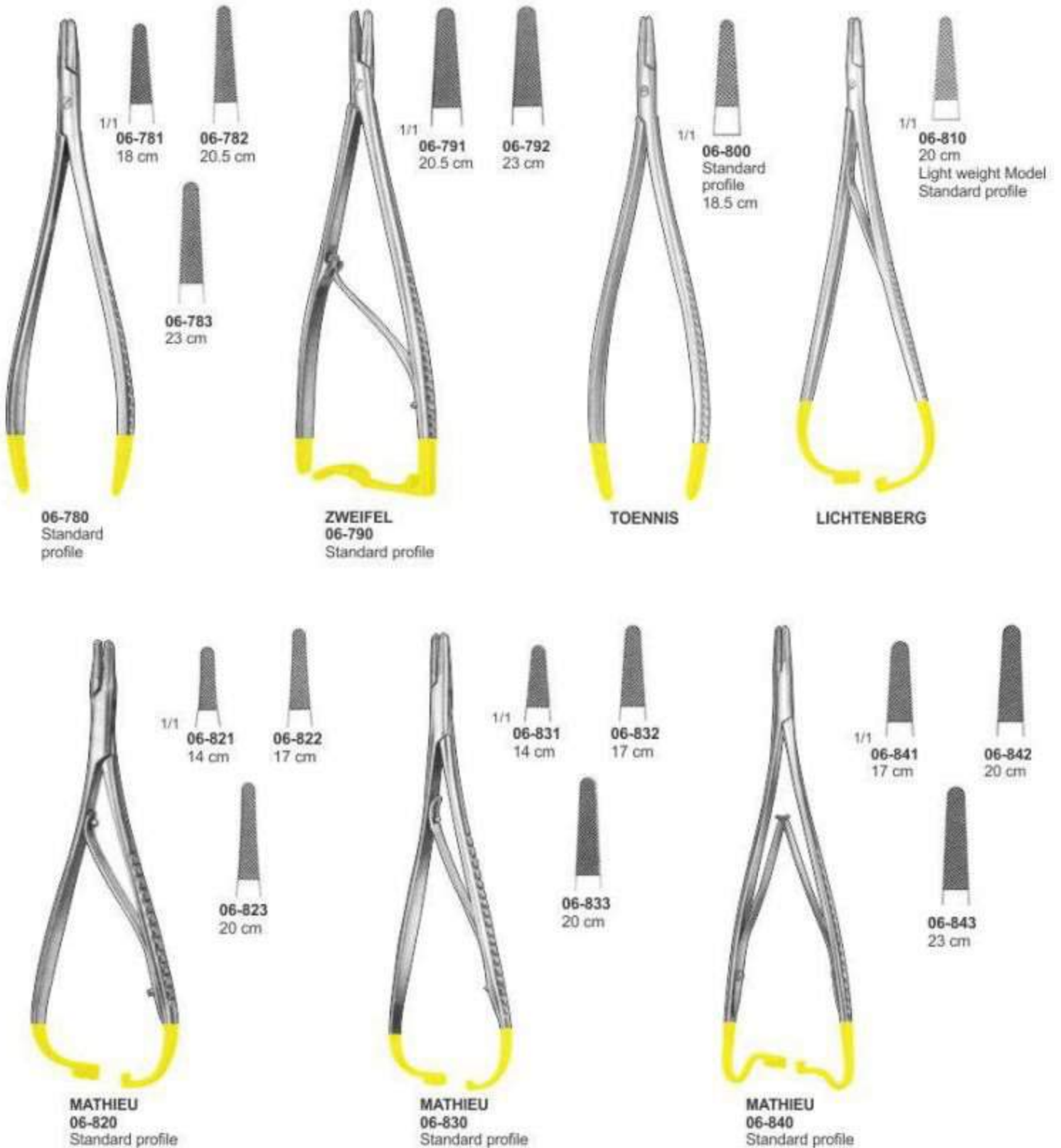

NEEDLE HOLDERS T.C.

Nadelhalter
Porta-agujas

Porte-agujas
Portaghi

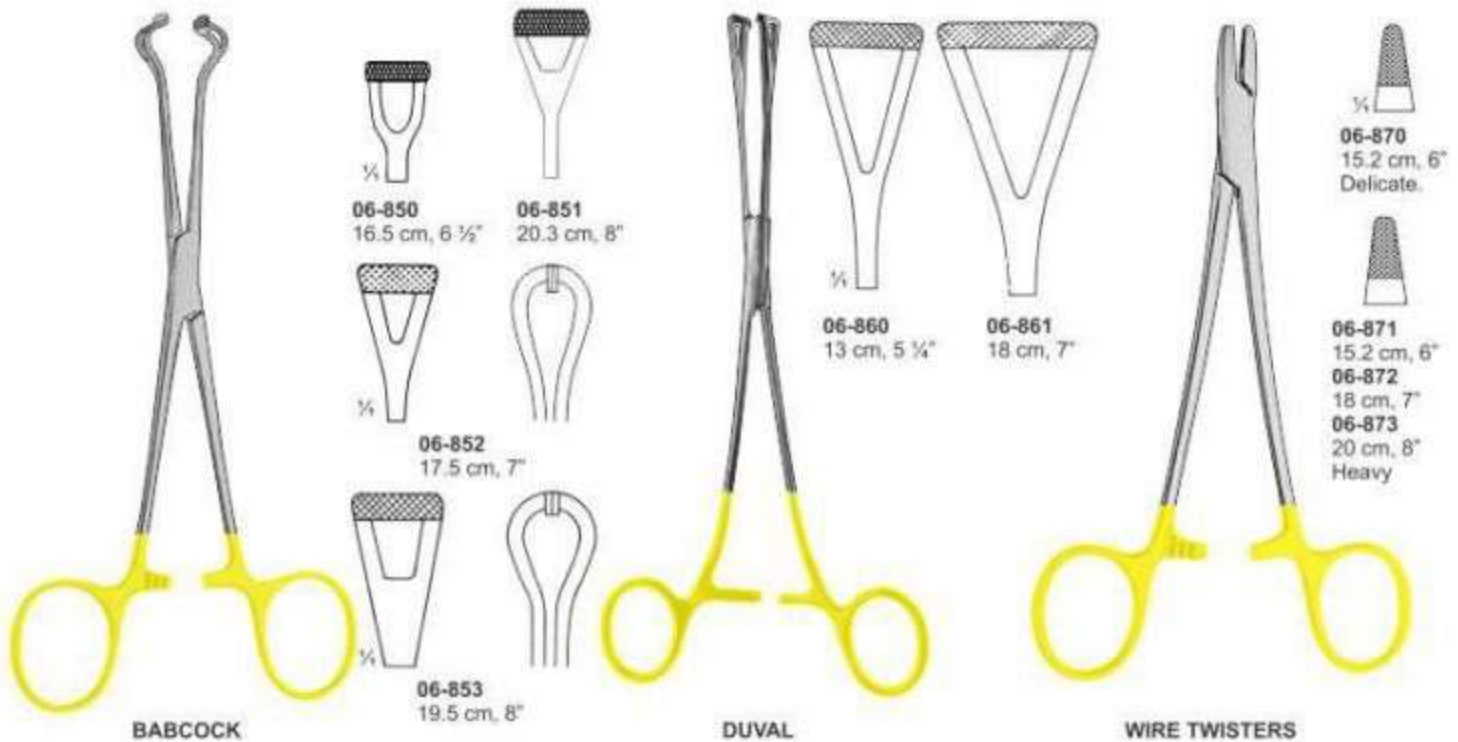

GENERAL INSTRUMENTS

Allgemeines Instrumentarium
Instrumental general

Instrumentation générale
Strumentario generale



MICHEL
06-920 12cm



MICHEL
06-930 12cm



WACHENFELDT
06-940 12.5cm



WACHENFELDT
06-950 12.5cm



HEGENBARTH
06-960 12.5cm



CHILDE
06-970 18cm



CHILDE
06-980 18cm



RICHTER-HEATH
06-990 14cm



COLLIN
06-1000 13cm



MICHEL
06-1010 12cm

GENERAL INSTRUMENTS

Allgemeines Instrumentarium
Instrumental general

Instrumentation générale
Strumentario generale

PROBES



- | | | |
|----------------|---------|----------------|
| 06-1020 11.5cm | 06-1030 | 06-1040 12.5cm |
| 06-1021 12.5cm | 06-1031 | 06-1041 14 cm |
| 06-1022 14 cm | 06-1032 | 06-1042 16 cm |
| 06-1023 16 cm | 06-1033 | |
| 06-1024 18 cm | 06-1034 | |
| 06-1025 20 cm | 06-1035 | |
| 06-1026 25 cm | 06-1036 | |

DIRECTOR



- | | |
|----------------|---------|
| 06-1050 12.5cm | 06-1060 |
| 06-1051 14 cm | 06-1061 |
| 06-1052 16 cm | 06-1062 |

SPATULA

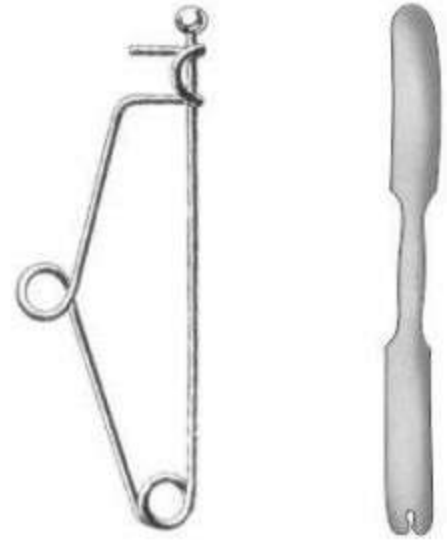

- | | |
|--------------|----------------|
| MAYO | PLASTER |
| 06-1070 14cm | 06-1080 13cm |
| | 06-1081 16cm |

NEEDLES



- | | |
|--------------|-------------|
| 06-1090 13cm | SYME |
| | 06-1100 |

DISSECTORS



- | | |
|-----------------|----------------|
| McDONALD | CHEYNE |
| 06-1110 19cm | 06-1120 12.5cm |
| | 06-1121 17.5cm |

APPLICATORS

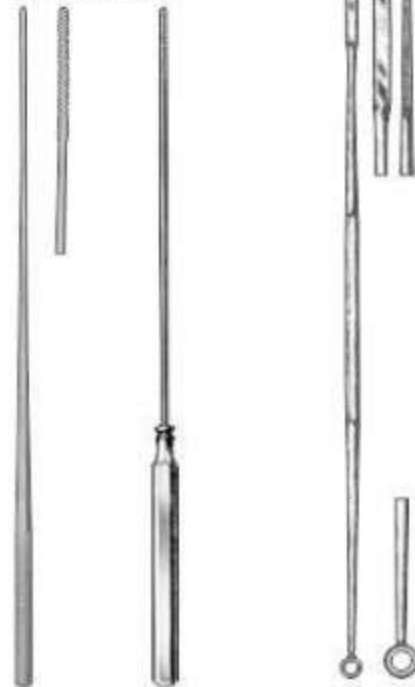

- | | |
|----------------|---------------------|
| FARRELL | JOBSON-HORNE |
| 06-1130 12cm | 06-1140 |
| 06-1131 14cm | 06-1141 |
| 06-1132 16cm | 06-1142 |
| 06-1133 18cm | 06-1143 |
| | 06-1150 12.5cm |
| | 06-1151 18 cm |

GENERAL INSTRUMENTS

Allgemeines Instrumentarium
Instrumental general

Instrumentation générale
Strumentario generale

BOWMAN LACRIMAL PROBES

Double Ended, Sterling Silver

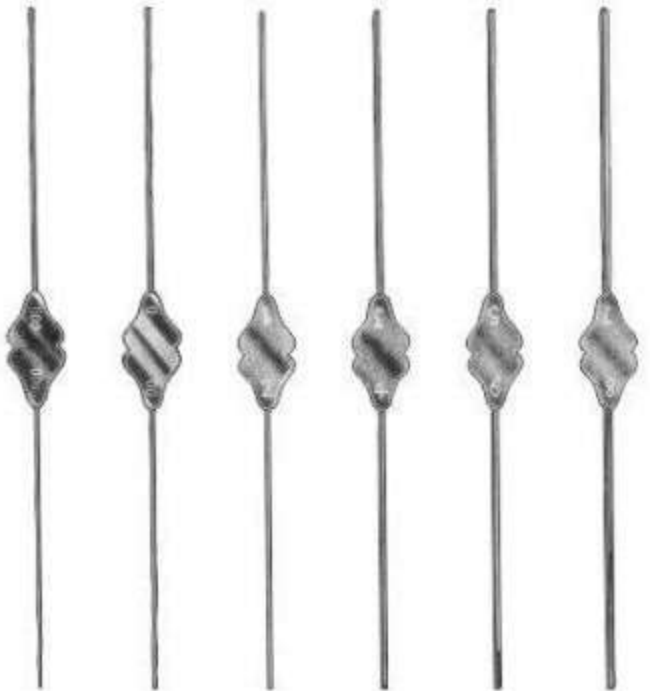

06-1160 Bowman Probe, 000-0000
06-1161 Bowman Probe, 00-0
06-1162 Bowman Probe, 1-2
06-1163 Bowman Probe, 3-4
06-1164 Bowman Probe, 5-6
06-1165 Bowman Probe, 7-8

WILLIAM LACRIMAL PROBES

Double Ended, Sterling Silver



06-1170 William Probe, 000-0000
06-1171 William Probe, 00-0
06-1172 William Probe, 1-2
06-1173 William Probe, 3-4
06-1174 William Probe, 5-6
06-1175 William Probe, 7-8



06-1180 14.5 cm, 5 3/4"
06-1181 16.0 cm, 6 1/4"
06-1182 20.0 cm, 8"
probes with eye



06-1190 14.5 cm, 5 3/4"
Myrtle leaf probe



06-1200 13.0 cm, 5"
06-1201 14.5 cm, 5 3/4"
06-1202 16.0 cm, 6 1/4"
06-1203 18.5 cm, 7"
06-1204 20.0 cm, 8"



06-1210 probe



06-1220 19.0 cm, 8 1/4"
Double ended probe, malleable, diam. of tips 3 mm with hole



06-1230 1.5 mm
06-1231 2.0 mm
06-1232 2.5 mm
30.0 cm, 12"

GENERAL INSTRUMENTS

Allgemeines Instrumentarium
Instrumental general

Instrumentation générale
Strumentario generale



DIRECTORS
06-1240 13 cm, 5"
06-1241 14.5 cm, 5 3/4"
06-1242 16 cm, 6"



DOYEN
06-1250
14.5 cm, 5 3/4"



NELATON
06-1260
16 cm, 6"



06-1270
14 cm, 5 1/2"
Director with tip
Diam. Of tip 3.3 mm



BRODIE
06-1280
20 cm, 8"
Director with tip
Diam. Of tip 3.5 mm



LOCKHART-MUMMERY
06-1290
16.5 cm, 6 1/2"



LOCKHART-MUMMERY
06-1300
16.5 cm, 6 1/2"



LOCKHART-MUMMERY
06-1310
16.5 cm, 6 1/2"

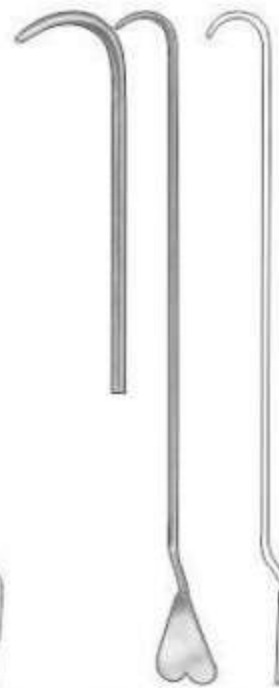

LOCKHART-MUMMERY
06-1320
16.5 cm, 6 1/2"



06-1330
19 cm, 7 1/4"
director with wire
loop, malleable

RETRACTORS

Wundhaken
Separadores

Ecarteurs
Divaricatori



US-ARMY
Set 2 pcs.
07-100 21.5 cm, 8 1/2"
28 x 15 / 42 x 15 mm
07-101 21.5 cm, 8 1/2"
25 x 15 / 38 x 15 mm

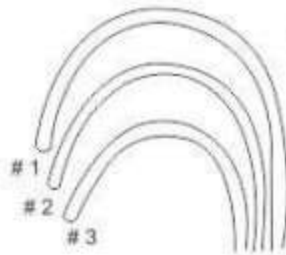

ROUX
Set 3 pcs. consisting of
1 07-110 14 cm, 5 1/2" 24 x 20 / 30 x 28 mm
2 07-111 15 cm, 6" 29 x 26 / 36 x 36 mm
3 07-112 17 cm, 6 1/4" 33 x 29 / 38 x 43 mm



FARABEUFG
Set 2 Pcs.
07-120 15 cm, 6"
27 x 16 / 30 x 16 mm
07-121 15 cm, 6"
23 x 16 / 26 x 16 mm



PARKER
07-130 13.5 cm, 5 1/4"
18 x 15 mm / 19 x 15 mm



DEEVER
07-140
18 cm, 7"



DEEVER
07-150
21.5 cm, 8 1/2"



DEEVER
07-160
23 cm, 9"



DEEVER
07-170
30 cm, 11 3/4"



DEEVER
07-180
33 cm, 13"



DEEVER
07-190
36 cm, 13 1/2"

HOOKLETS, RETRACTORS

Wundhäkchen, Wundhaken
Ganchito, Separadores

Crochet, Ecarteurs
Divaricatore, Divaricatori



38 mm

DEAVER
07-200
30 cm, 11 3/4"



50 mm

DEAVER
07-210
30 cm, 11 3/4"



75 mm

DEAVER
07-220
30 cm, 11 3/4"



HARRINGTON
07-230
32 cm, 12 3/4" 127 x 40 mm
07-231
32 cm, 12 3/4" 127 x 62 mm



16 cm, 6 1/4"
flexible



07-240



07-241



07-242



07-243



07-244



07-245



16.5 cm, 6 1/2"
flexible



07-250
sharp



07-251
blunt

HOOKELETS, RETRACTORS

*Wundhäkchen, Wundhaken
Ganchito, Separadores*

*Crochet, Ecarteurs
Divaricatore, Divaricatori*



KOCHER
Sharp

- 07-260 22 cm, 8 3/4" 15 x 10 mm Fig. 1
- 07-261 22 cm, 8 3/4" 15 x 15 mm Fig. 2
- 07-262 22 cm, 8 3/4" 15 x 20 mm Fig. 3
- 07-263 22 cm, 8 3/4" 15 x 30 mm Fig. 4
- 07-264 22 cm, 8 3/4" 15 x 40 mm Fig. 5



KOCHER
Blunt

- 07-270 22 cm, 8 3/4" 15 x 10 mm Fig. 1
- 07-271 22 cm, 8 3/4" 15 x 15 mm Fig. 2
- 07-272 22 cm, 8 3/4" 15 x 20 mm Fig. 3
- 07-273 22 cm, 8 3/4" 15 x 30 mm Fig. 4
- 07-274 22 cm, 8 3/4" 15 x 40 mm Fig. 5



SENN-MUELLER
07-280
18 x 6 mm
16 cm, 6 1/4" sharp



MEYERDING
18 cm, 7"



07-290
18 x 7 mm
Blunt



07-292
7 x 4 mm
Toothed



07-294
7 x 4 mm
Saddle Shaped



07-291
16 x 5 mm
Toothed



07-293
10 x 3 mm
Blunt



07-295
10 x 4 mm
Sharp



LANGENBECK
07-300
22 cm, 8 3/4"



07-301
25 x 6 mm



07-303
35 x 11 mm



07-305
41 x 11 mm



07-307
70 x 14 mm



07-302
25 x 6 mm



07-304
35 x 11 mm



07-306
41 x 11 mm



LANGENBECK
07-320
22 cm, 8 3/4"

RETRACTORS

Wundhaken
Separadores

Ecarteurs
Divaricatori



07-330
23 x 20 mm

07-331
30 x 29 mm

07-332
37 x 37 mm



RICHARDSON
24.0 cm 9.5"

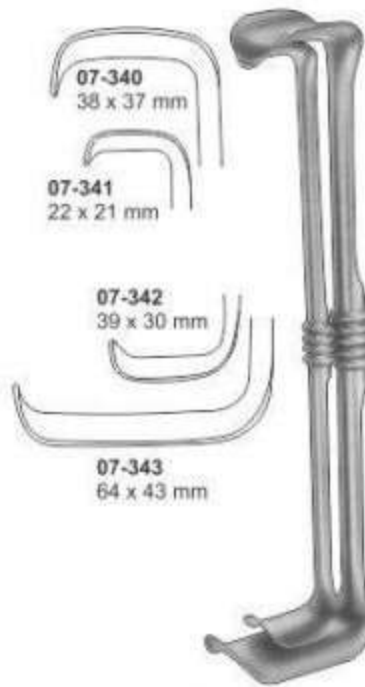

07-340
38 x 37 mm

07-341
22 x 21 mm

07-342
39 x 30 mm

07-343
64 x 43 mm

RICHARDSON-EASTMAN
07-344
25.0 cm 10", Set of 2 piece



KOCHER
07-350 40 x 10 mm
22 cm, 8 1/2"
07-351 40 x 15 mm
22 cm, 8 1/2"
07-352 40 x 20 mm
22 cm, 8 1/2"



FRITSCH
07-360 35 x 40 mm
24 cm, 9 1/2"



MORRIS
07-370 90mm
07-371 100mm
07-372 115mm



57x64mm 48mm

57x50mm 48mm

MORRIS
07-380 48mm



LANGENBECK
07-390 22 x 6 mm
07-391 44 x 13 mm



DURHAM
07-400 13 mm
07-401 19 mm

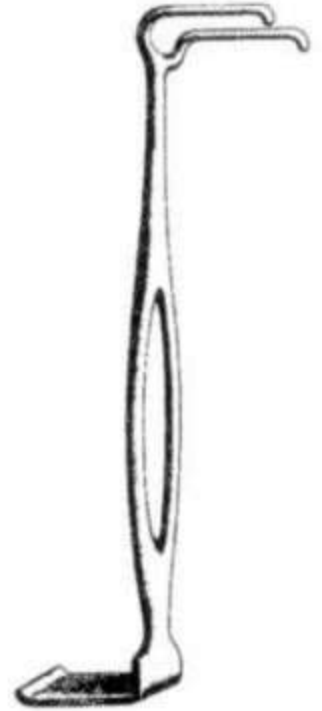

CZERNY
07-410 20 mm

RETRACTORS

Wundhaken
Separadores

Ecarteurs
Divaricatori

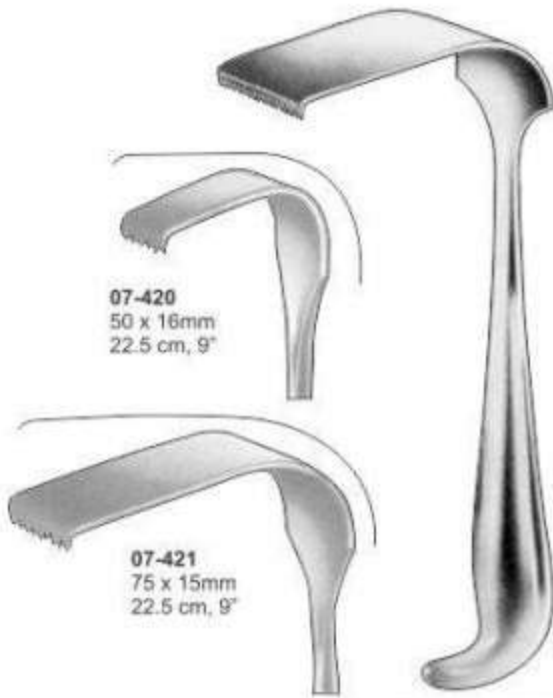

07-420
50 x 16mm
22.5 cm, 9"

07-421
75 x 15mm
22.5 cm, 9"

MEYERDING
07-422 75 x 25mm
22.5 cm, 9"

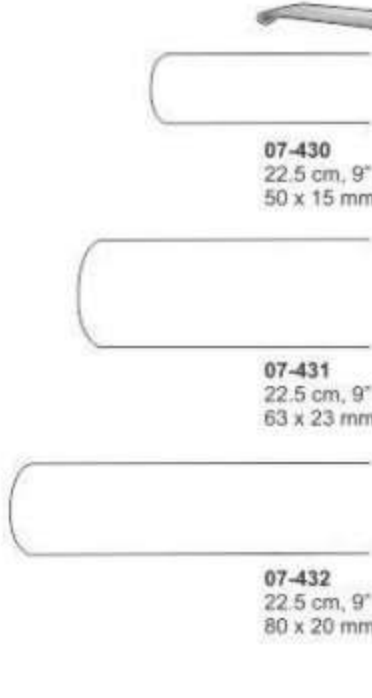

07-430
22.5 cm, 9"
50 x 15 mm

07-431
22.5 cm, 9"
63 x 23 mm

07-432
22.5 cm, 9"
80 x 20 mm



SAUERBRUCH
22.5 cm, 9"



DOYEN
07-440
50 x 85 mm
25 cm, 10"



KELLY
07-450 190 x 38 mm
27 cm, 10 1/2"
07-451
190 x 57 mm 27 cm, 10 1/2"



MIKULICZ
07-460
28 cm, 10 1/2"
95 x 35 mm



DARTIGUS
07-470
65 x 45 mm

RETRACTORS

Wundhaken
Separadores

Ecarteurs
Divaricatori



COOLEY
07-480
25 cm, 10"
Right



COOLEY
07-490
27 cm, 10 1/2"
Left



COOLEY
07-500
25 cm, 10"
Right - Serrated



MAYO ABDOMINAL
RETRACTOR
07-510
25 cm, 10"
69 x 254 mm



C.W. MAYO ABDOMINAL
RETRACTOR
07-520 25.7 cm, 10 1/4"
Blade 70 mm wide.
07-521 24.8 cm, 10"
Blade 79 mm wide.



BREWSTER RETRACTOR
07-530 Style A 19 x 38 mm
07-531 Style B 45 x 25 mm
07-532 Style C 50 x 45 mm
07-533 Style D 57 x 45 mm
07-534 Style E 64 x 45 mm
24 cm, 9 1/2"



KELLY RETRACTOR
07-540 23 cm, 9" 38 x 50 mm
07-541 24 cm, 9 1/2" 50 x 64 mm
07-542 25 cm, 10" 64 x 76 mm
07-543 26 cm, 10 1/4" 69 x 82 mm



SIMS-KELLY RETRACTOR
07-550 57 x 25 mm
07-551 69 x 45 mm
07-552 76 x 38 mm
24 cm, 9 1/2"



ZAIKIND LUNG RETRACTOR
07-560 Malleable 50 x 305 mm
07-561 Malleable 76 x 305 mm
25 cm, 10"

RETRACTORS

Wundhaken
Separadores

Ecarteurs
Divaricatori

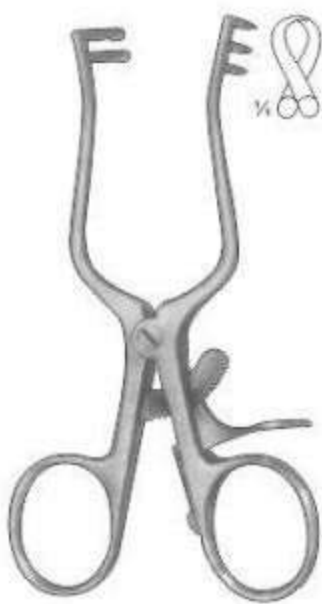

WEITLANER
07-570
Sharp
11.0 cm

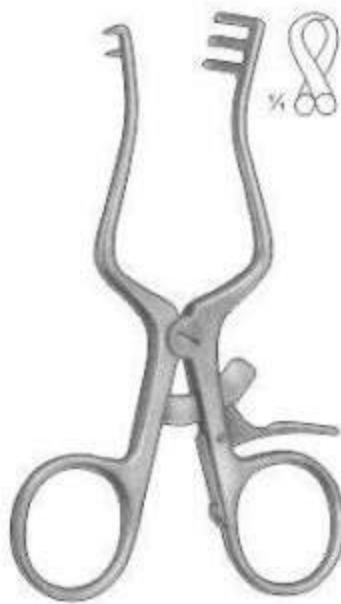

WEITLANER
07-580
Semi-Sharp
11.0 cm



WEITLANER
07-590
Blunt
11.0 cm

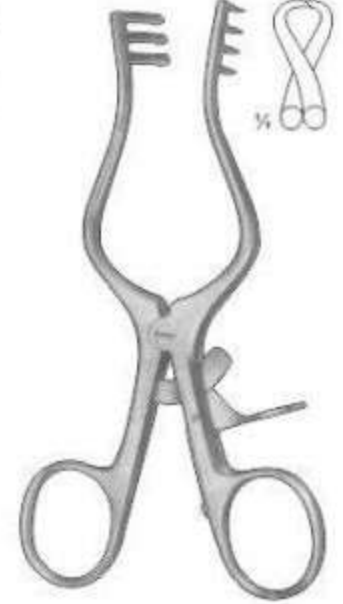

WEITLANER
07-600
Sharp
13.0 cm



WEITLANER
07-610
Semi-Sharp
13.0 cm



WEITLANER
07-620
Blunt
13.0 cm



MILLIGAN
07-630
18.5 mm x 20 mm
Blunt, 3:3
13 cm, 5"



JANSEN
07-640 10 cm, 4"
Sharp 3:3
07-641 10 cm, 4"
Blunt 3:3



GELPI-LOKTITE
07-650
18 cm, 7"

RETRACTORS

Wundhaken
Separadores

Ecarteurs
Divaricatori



BECKMANN-ADSON
07-660
31 cm, 12 1/4"
Sharp



BECKMANN-ADSON
07-661
31 cm, 12 1/4"
Semi-Sharp



ADSON
07-670
32 cm, 12 1/2"
Semi-Sharp



BECKMANN-EATON
07-680
32 cm, 12 1/2"
Sharp

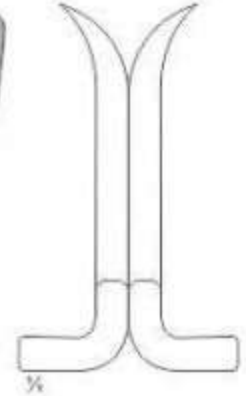

HENLEY

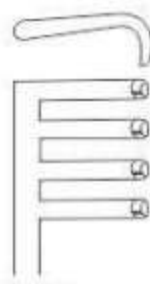

07-690
16 cm, 6 1/4"
3 x 4 mm
blunt

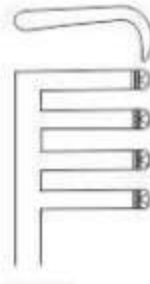

07-691
16 cm, 6 1/4"
3 x 4 mm
sharp



MISKIMON
07-700 22 cm, 8 3/4"
33 mm x 38 mm
Sharp, 7:7



07-710
32 cm, 12 1/2"
semi-sharp
4 x 5 teeth
26 mm



ADSON-BABY
07-711
16 cm, 6 1/4" sharp
3 x 4 teeth
13 mm



ADSON-BABY
07-712
16 cm, 6 1/4" blunt
3 x 4 teeth
13 mm



RETRACTORS

Wundhaken
Separadores

Ecarteurs
Divaricatori



PLESTER



07-720
11 cm, 4 1/2"
fig. 1 Blunt



07-721
11 cm, 4 1/2"
fig. 2 Blunt



GELPI
Vaginal Retractor
07-730
13.5 cm, 5"



GELPI
Skin- and Vaginal Retractor
07-740
17.5 cm, 7"



CLOWARD modif.
07-750
Spreader Only



40 mm
16 mm
07-751



45 mm
16 mm
07-752



40 mm
16 mm
07-753



45 mm
16 mm
07-754



60 mm
16 mm
07-755



50 mm
16 mm
07-756

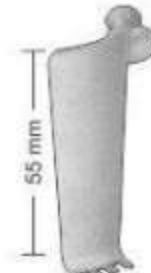

55 mm
16 mm
07-757



50 mm
16 mm
07-758

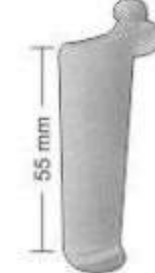

55 mm
16 mm
07-759



60 mm
16 mm
07-760

RETRACTORS

Wundhaken
Separadores

Ecarteurs
Divaricatori

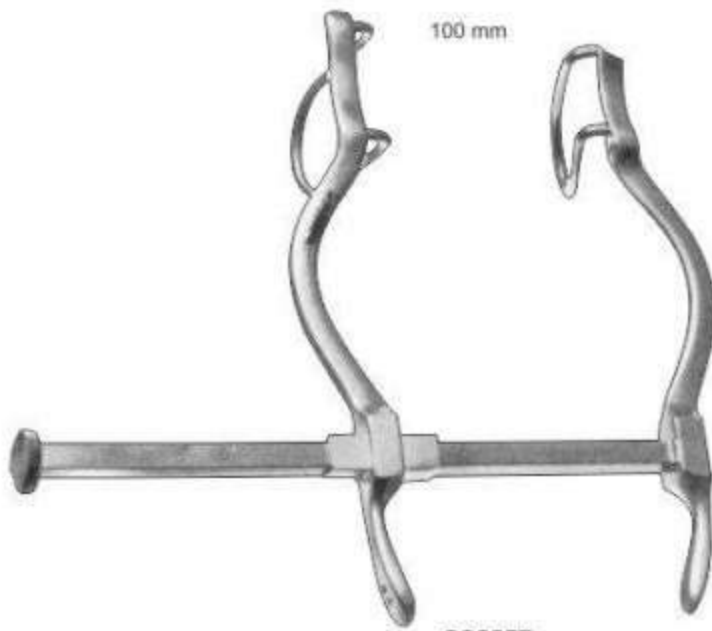

GOSSET
07-770
Center Blades 40 x 30 mm

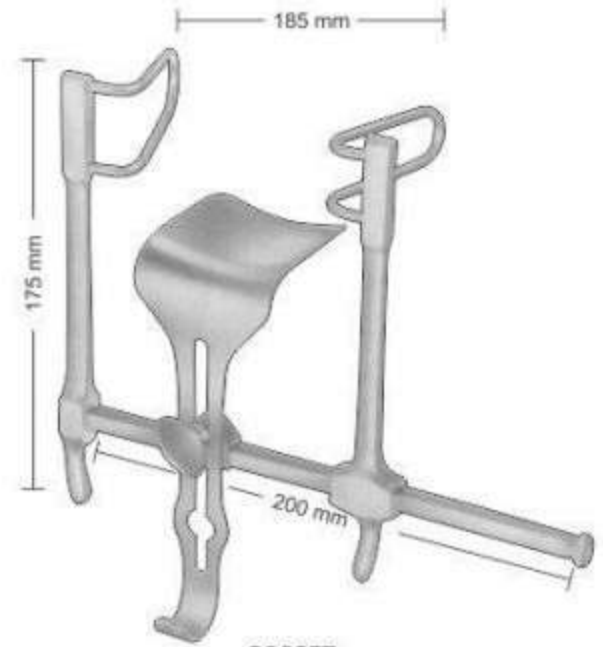

GOSSET
07-780
Lateral Blades 58 mm deep
Center blade 59 x 57 mm

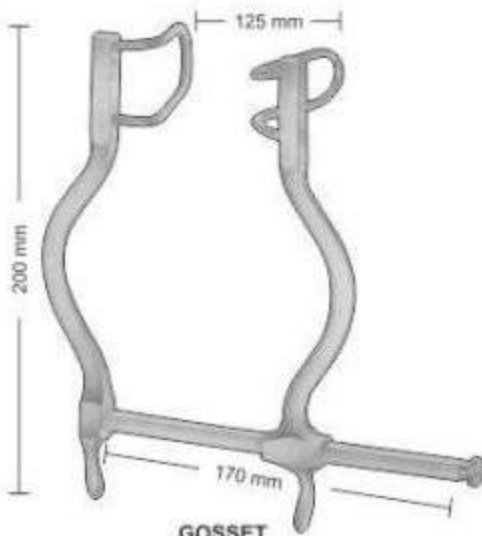

GOSSET
07-790
Blades: 55mm deep

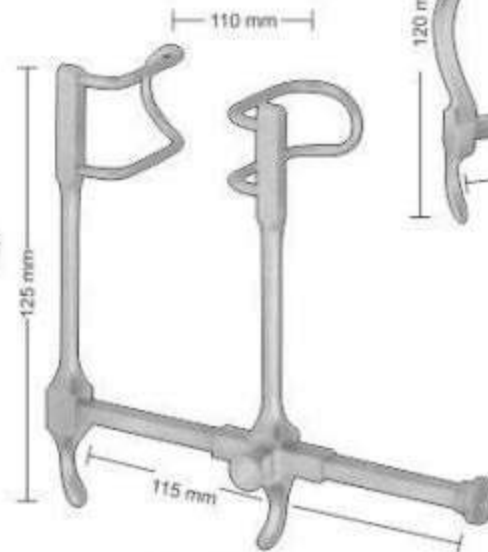

GOSSET
07-800
Blades: 38 mm deep

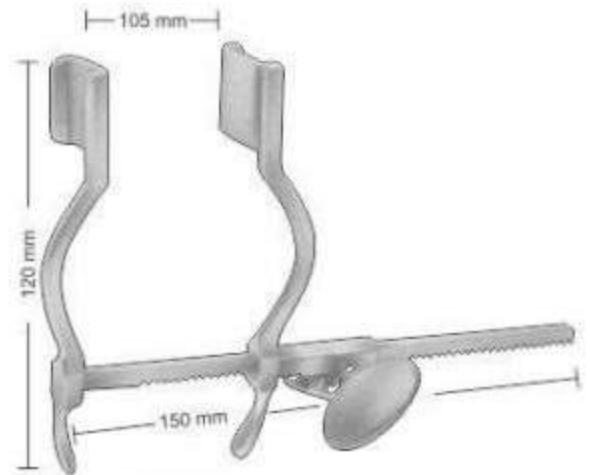

HERTZLER
07-810
Blades 20 x 25 mm

RETRACTORS

Wundhaken
Separadores

Ecarteurs
Divaricatori

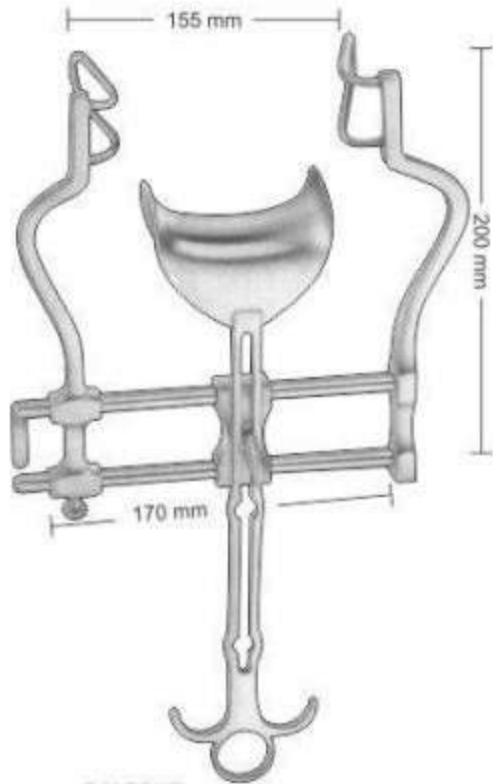

BALFOUR 07-820
Lateral blades 60 mm deep
Center blade 47 x 80 mm

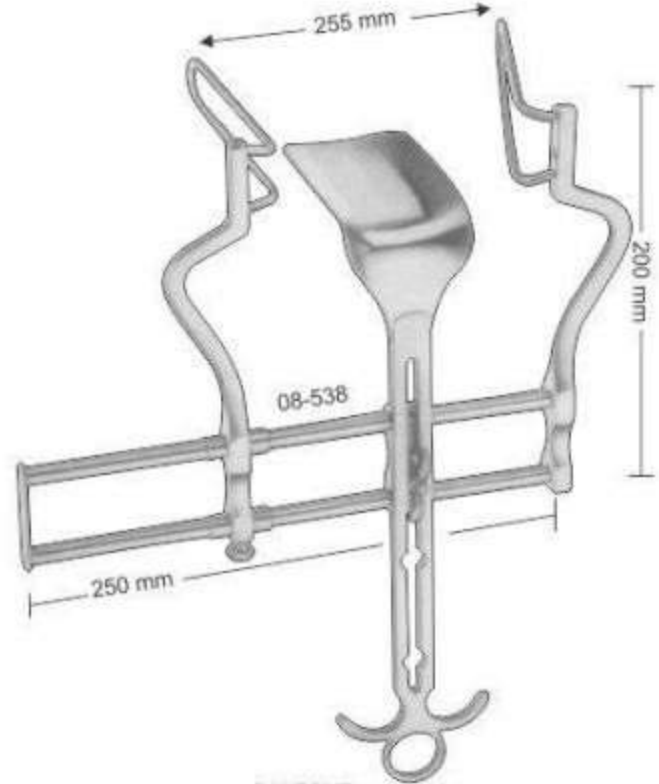

BALFOUR 08-538
Lateral blades 105 mm deep
Center blade 107 x 59 mm



07-840
Center blade only
54 x 80 mm

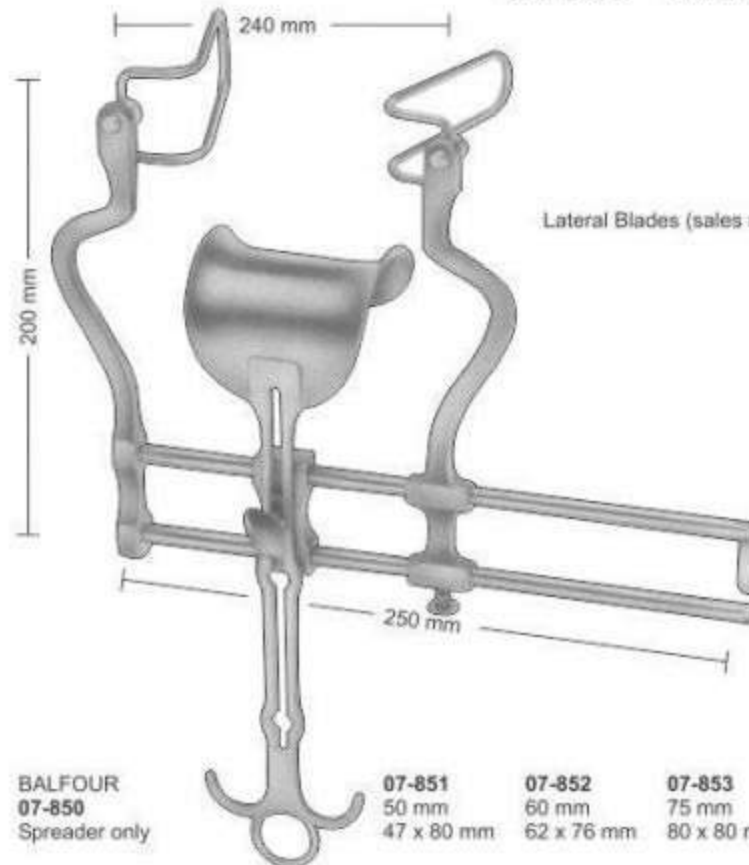

BALFOUR 07-850
Spreader only

07-851
50 mm
47 x 80 mm

07-852
60 mm
62 x 76 mm

07-853
75 mm
80 x 80 mm

07-854
90 mm
80 x 80 mm

Lateral Blades (sales unit of blades in pairs)

RETRACTORS

Wundhaken
Separadores

Ecarteurs
Divaricatori



O'SULLIVAN/O'CONNOR

- 07-860 (Set includes frame & 3 blades)
- 07-861 Frame Only (not pictured)



07-862
Single Retractor Blade
110 x 70 mm



07-863
Set of 2 Retractor Blade
80 x 45 mm

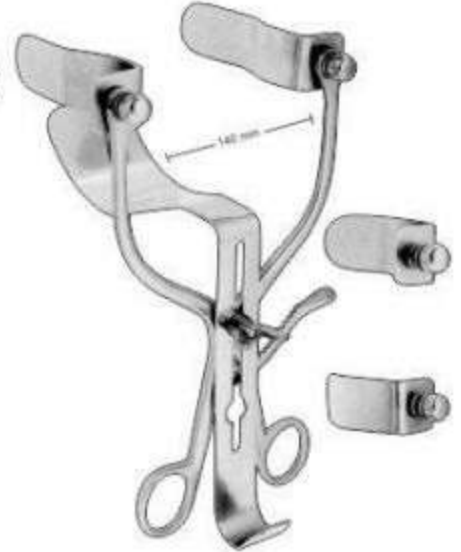

COLLIN

- 07-870 Complete
- 07-871 Spreader only
- 07-872 Blades 55 x 25 mm
- 07-873 Blades 80 x 25 mm
- 07-874 Center Blade
115 x 45 mm



07-880
Center Blade
45 x 80 mm
70 x 85 mm

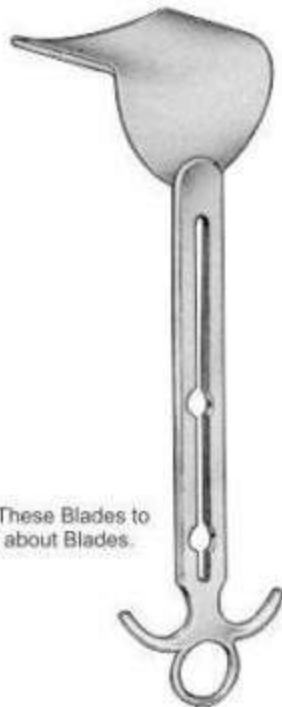

07-890
Center Blade
100 x 60 mm

Sizes of These Blades to
Same as about Blades.

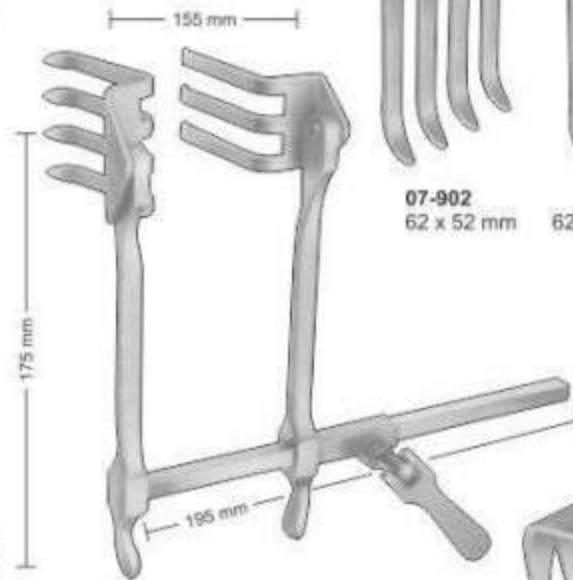

SCOVILLE-RICHTER

- 07-900 Complete with 1 pair blades.
- 07-901 Frame only.
The Retractor bar and shanks may be easily rotates 180 when blades are in situ.



07-902
62 x 52 mm



62 x 37 mm



07-903
47 x 51 mm



07-904
30 x 40 mm



07-905
37 x 62 mm

RETRACTORS

Wundhaken
Separadores

Ecarteurs
Divaricatori



BABY-COLLIN
07-910
with 2 pair of blades

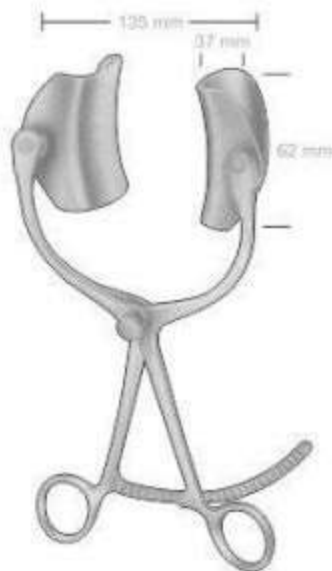

COLLIN
07-920
complete



COLLIN
07-930
Spreader Only



RICARD
07-950 Complete
07-951 Spreader only
Lateral blade 07-952 07-954
58x80mm 72x84mm
Center blade 07-953 07-955
54x70mm 72x90mm

Lateral blade	07-931 37x62mm	07-933 37x80mm	07-935 37x98mm
Center blade	07-932 54x55mm	07-934 54x67mm	07-936 52x76mm



HOLZBACH
07-970 Complete
07-971 Spreader only
07-972 Lateral blade 59x80mm
07-973 Center blade 74x82mm



COLLIN
07-980 20 cm, 8"
complete with 2 lateral
blades and central blade



LEGUEU
07-990
17 cm, 6 3/4"



DOYEN
07-1000 48 mm x 90 mm
07-1001 48 mm x 105 mm
07-1002 48 mm x 120 mm
07-1003 48 mm x 135 mm
28 cm, 11"



ROCHARD
07-1010 48 mm x 90 mm
07-1011 48 mm x 105 mm
07-1012 48 mm x 120 mm
07-1013 48 mm x 135 mm
07-1014 48 mm x 155 mm
31 cm, 12"

RETRACTORS

Wundhaken
Separadores

Ecarteurs
Divaricatori

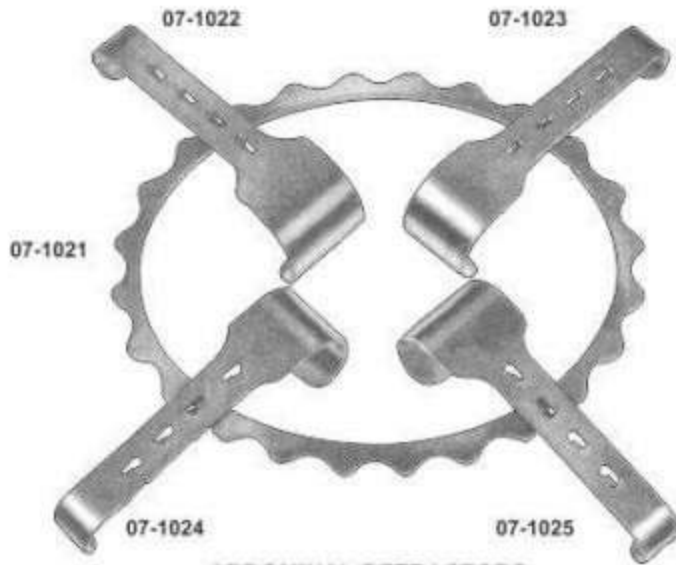

ABDOMINAL RETRACTORS
for new-born and children

DENIS-BROWNE

07-1020 Complete with 4 blades

07-1021 Frame 190 x 160 mm

07-1022 2 blades only 40 x 30 mm

07-1023 2 blades only 40 x 40 mm

07-1024
Blades only 20 x 30 mm

07-1025
Blades only 20 x 40 mm



ABDOMINAL RETRACTORS
well suitable for gynaecologists

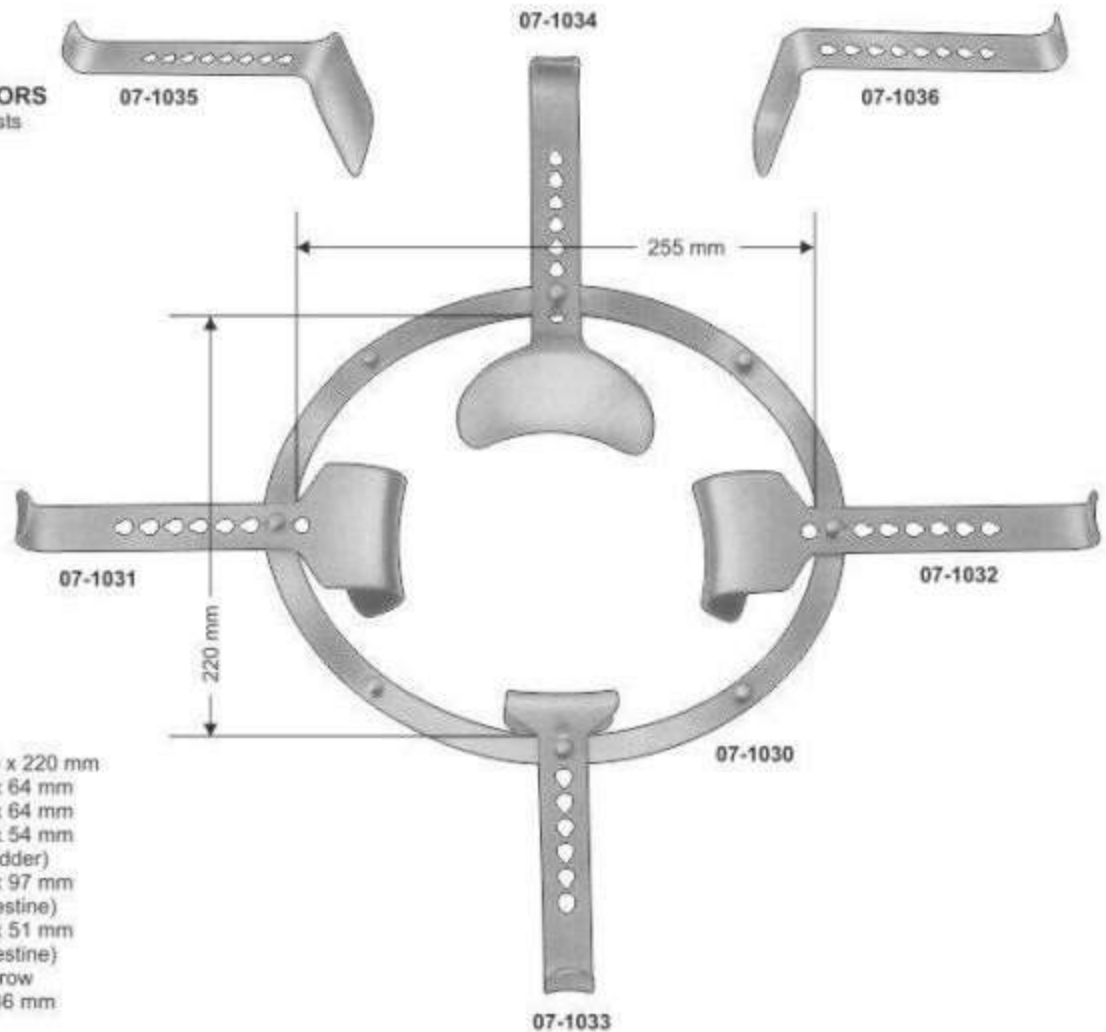

SEMM

consisting of:

- 07-1030 1 frame 225 x 220 mm
- 07-1031 1 blade 46 x 64 mm
- 07-1032 1 blade 46 x 64 mm
- 07-1033 1 blade 53 x 54 mm
(for bladder)
- 07-1034 1 blade 82 x 97 mm
(for intestine)
- 07-1035 1 blade 98 x 51 mm
(for intestine)
- 07-1036 1 blade, narrow
107 x 36 mm

RETRACTORS

Wundhaken
Separadores

Ecarteurs
Divaricatori

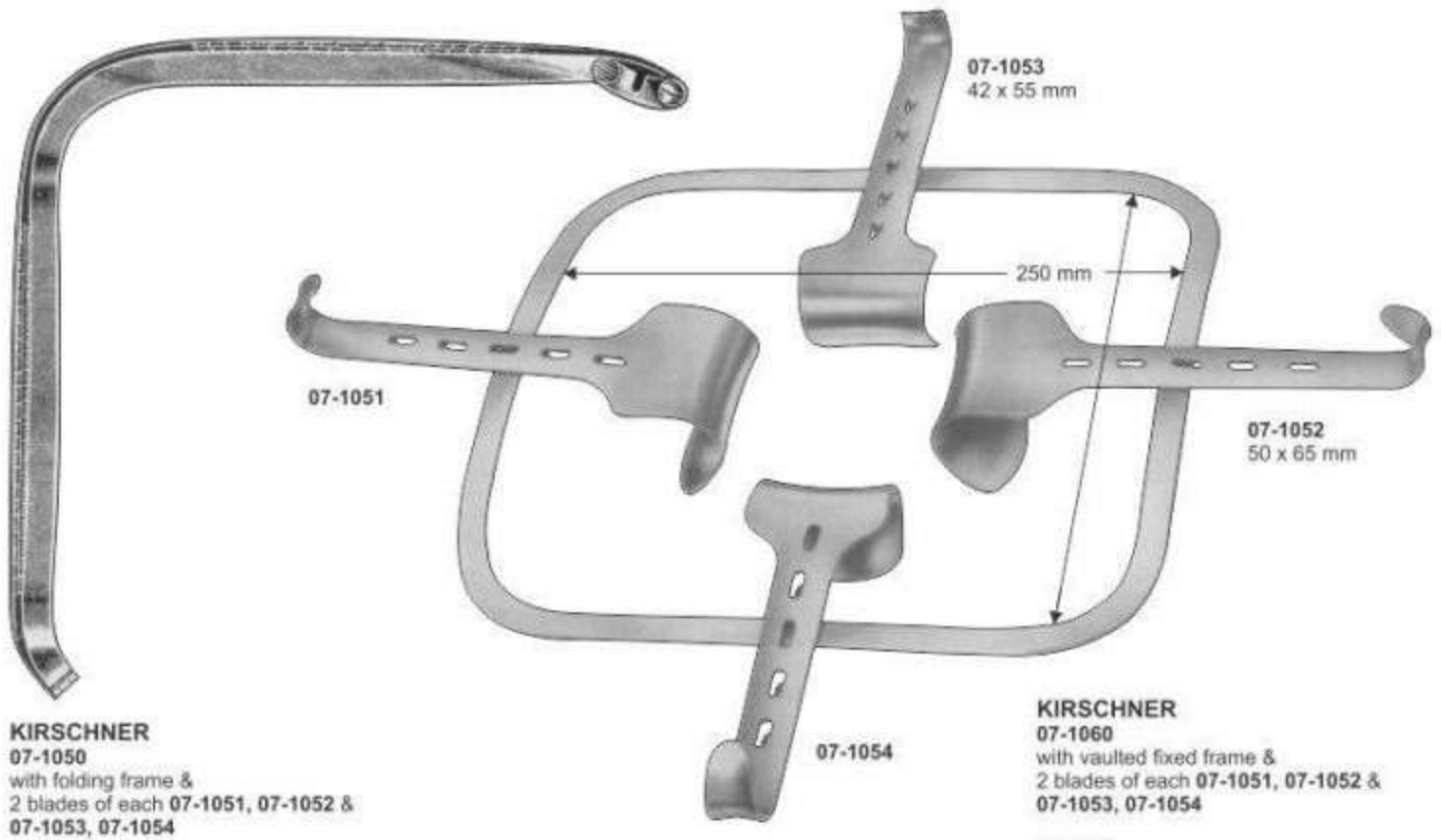

KIRSCHNER
07-1050
with folding frame &
2 blades of each **07-1051**, **07-1052** &
07-1053, **07-1054**

KIRSCHNER
07-1060
with vaulted fixed frame &
2 blades of each **07-1051**, **07-1052** &
07-1053, **07-1054**

07-1061
300 x 380 mm
Frame only, over-sized

07-1062
320 x 300 mm
Frame only

Additional valves for corpulent persons



KIRSCHNER
07-1070
64 x 80 mm

KIRSCHNER-BALFOUR
07-1080
80 x 82 mm

KIRSCHNER
07-1090 90 x 69 mm
07-1091 92 x 95 mm
07-1092 78 x 58 mm

KIRSCHNER
07-1100 108 x 42 mm
07-1101 91 x 55 mm
07-1102 121 x 55 mm

THORACIC/CARDIOVASCULAR

Thorax-cardiovasculaire
Thorax-cardiovasculaire

Torace-cardiovascolare
Torax-cardiovascular

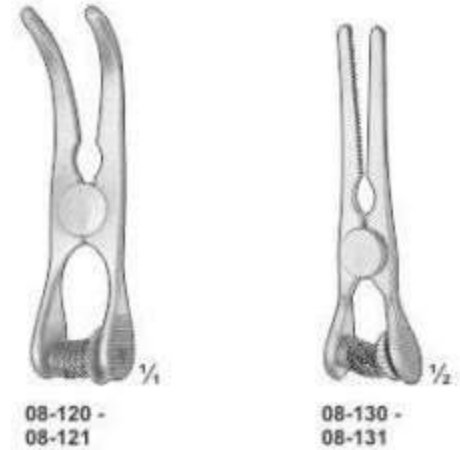
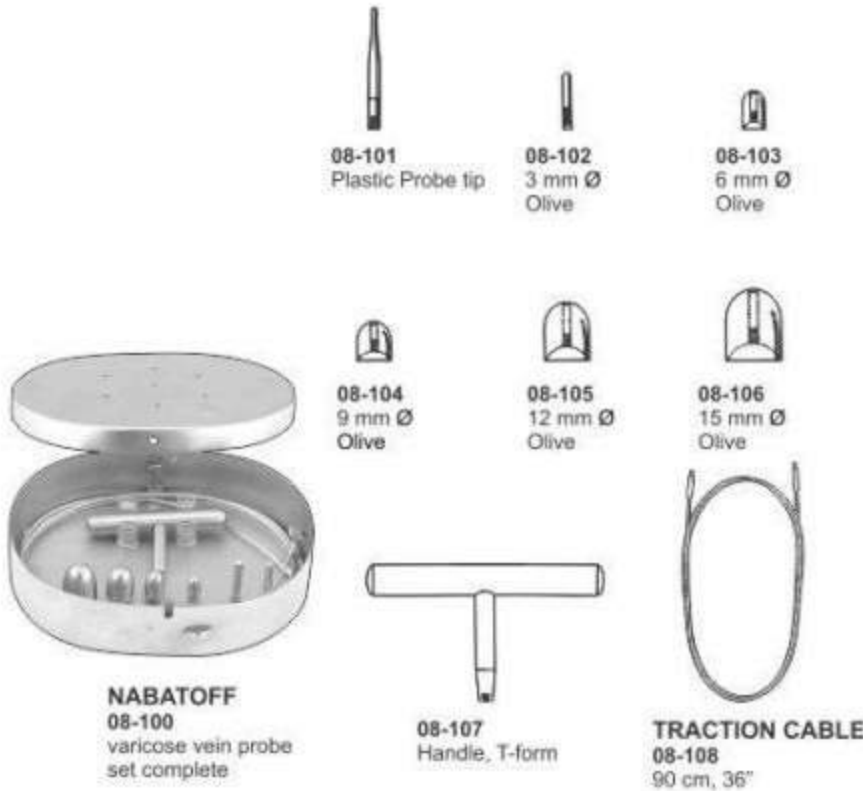

COOLEY Atraumatic Bulldog Clamp

Cat.#	Jaw Length mm	Jaw	Length
08-120	20	Str.	5.0 cm, 2"
08-121	30	Str.	5.5 cm, 2 5/8"
08-130	47	Str.	9.5 cm, 3 3/8"
08-131	60	Str.	12.5 cm, 5"

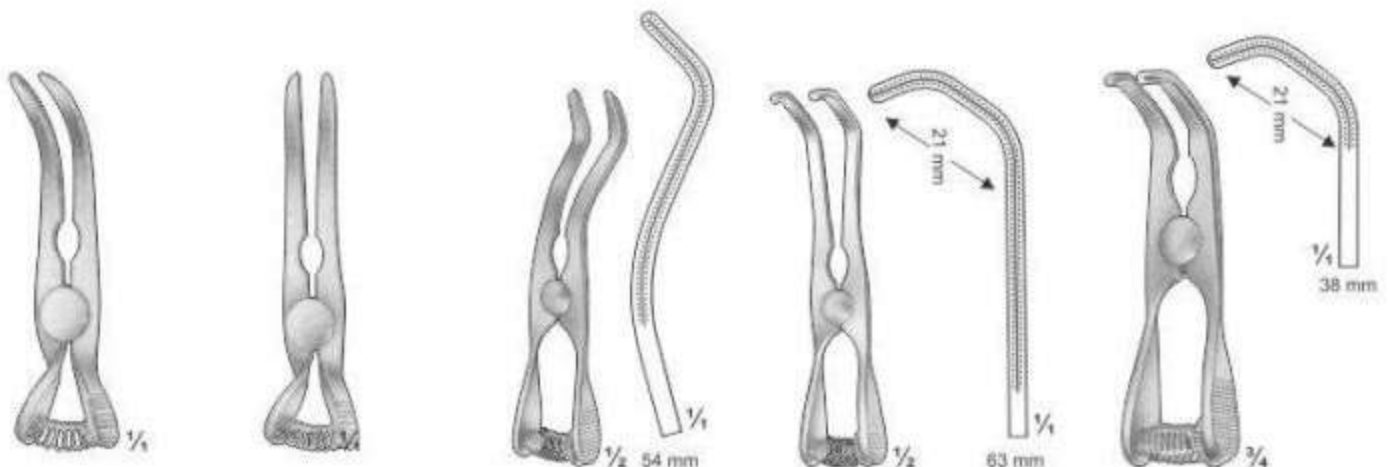

DE BAKKEY ATRAUMATIC MIN

DE BAKKEY ATRAUMATIC MIN

08-140
5.0 cm, 2"
Jaw Length 27 mm
Straight

08-141
5.0 cm, 2"
Jaw Length 27 mm
Curved

08-150
10 cm, 4"
Jaw Length 54 mm
S-Ship

08-151
10 cm, 4"
Jaw Length 63 mm
Multi







08-152
7 cm, 2 3/4"
Jaw Length 38 mm
Multi

THORACIC/CARDIOVASCULAR

Thorax-cardiovasculaire
Thorax-cardiovasculaire







Torace-cardiovascolare
Torax-cardiovascular



-  **08-160**
3.8 cm, 1 1/2"
-  **08-161**
3.8 cm, 1 1/2"
-  **08-162**
5.1 cm, 2"
-  **08-163**
6 cm, 2 1/2"
-  **08-164**
6 cm, 2 1/2"
-  **08-165**
6 cm, 2 1/2"



DIEFFENBACH



-  **08-170**
4.9 cm, 2"
Jaw 8 mm
Straight
-  **08-171**
5.3 cm, 2"
Jaw 12 mm
Straight
-  **08-172**
5.9 cm, 2 1/2"
Jaw 20 mm
Straight
-  **08-173**
4.3 cm, 1 3/4"
Jaw 8 mm
Curved
-  **08-174**
4.5 cm, 1 3/4"
Jaw 12 mm
Curved
-  **08-175**
5 cm, 2"
Jaw 20 mm
Curved

DIETRICH



-  **08-180**
4.3 cm, 1 3/4"
Jaw 13 mm
Curved
-  **08-181**
4.9 cm, 2"
Jaw 18 mm
Curved
-  **08-182**
5.4 cm, 2 1/4"
Jaw 20 mm
Curved





BULLDOG CLAMP



- 08-190** 3.8 cm, 1 1/2"
- 08-191** 5.0 cm, 2"
- 08-192** 5.5 cm, 2 1/8"
- 08-193** 6.0 cm, 2 1/2"
- 08-194** 7.0 cm, 2 3/4"
- 08-195** 8.0 cm, 3 1/8"
- 08-196** 8.5 cm, 3 1/2"





JOHNS-HOPKINS



-  **08-200**
8 cm, 3 1/4"
Jaw 20 mm
Straight
-  **08-201**
9 cm, 3 1/2"
Jaw 30 mm
Straight
-  **08-202**
10.5 cm, 4"
Jaw 45 mm
Straight
-  **08-203**
12.5 cm, 5"
Jaw 68 mm
Straight

DEBAKEY



-  **08-210**
7.5 cm, 3"
Jaw 20 mm
Curved
-  **08-211**
8.5 cm, 3 1/2"
Jaw 30 mm
Curved
-  **08-212**
9.5 cm, 3 3/4"
Jaw 45 mm
Curved
-  **08-213**
11.5 cm, 4 1/2"
Jaw 68 mm
Curved



DEBAKEY



-  **08-220**
9 cm, 3 1/2"
-  **08-221**
11 cm, 4 1/2"

GREGORY-SOFT



-  **08-230**
left
-  **08-231**
right

GREGORY-SOFT
11 cm, 4 1/2"

THORACIC/CARDIOVASCULAR

Thorax-cardiovasculaire
Thorax-cardiovasculaire

Torace-cardiovascolare
Torax-cardiovascular

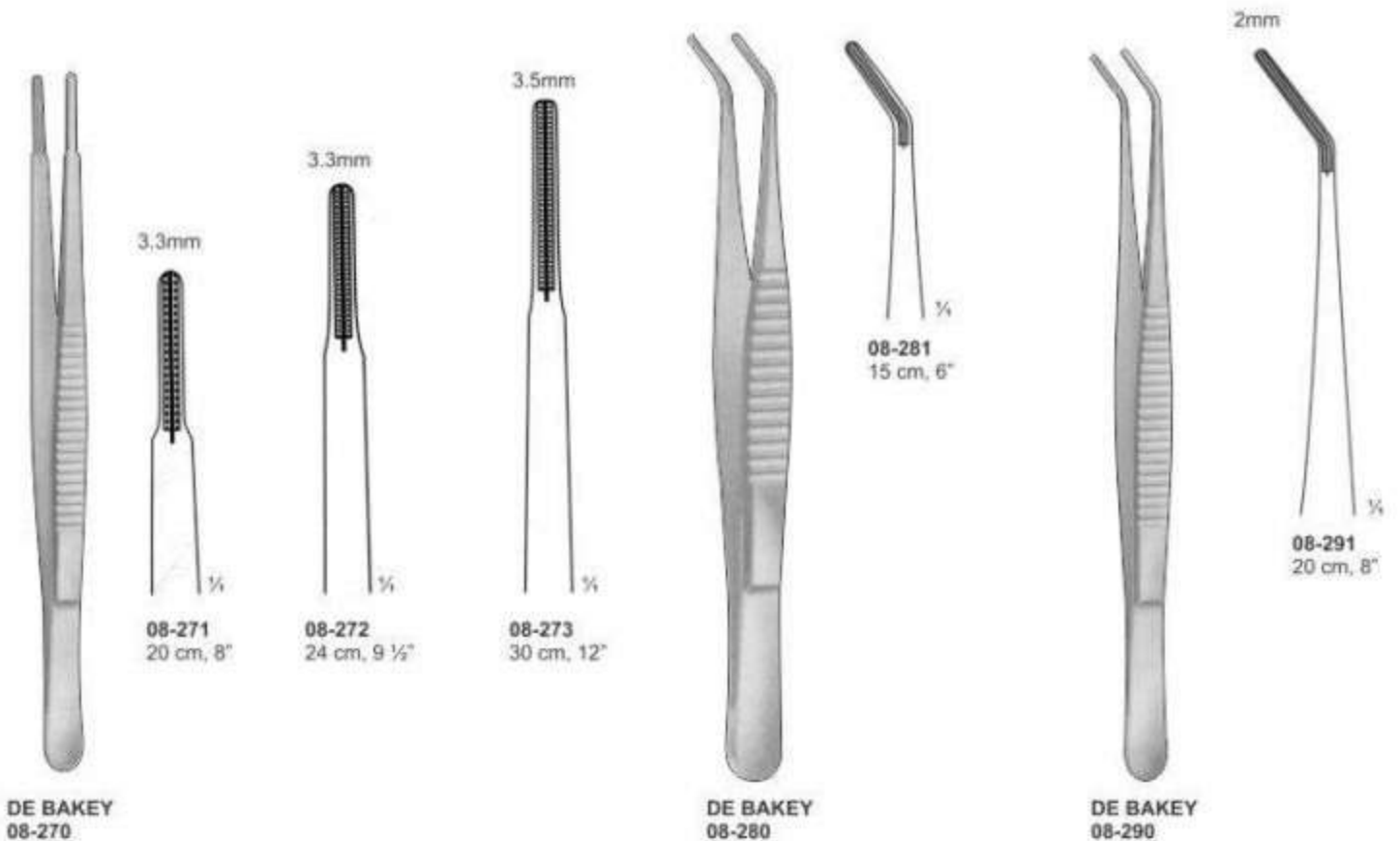
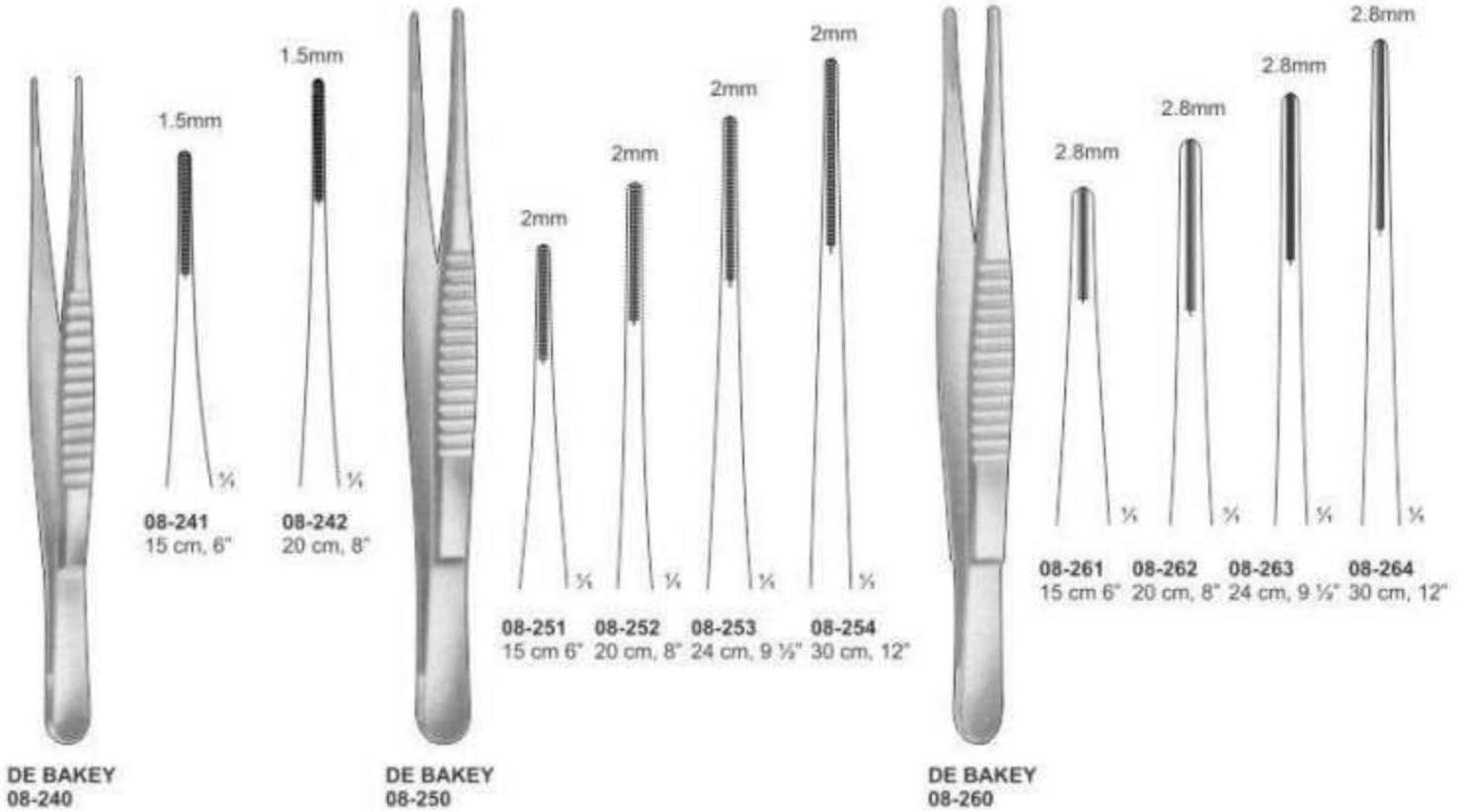

THORACIC/CARDIOVASCULAR

Thorax-cardiovasculaire
Thorax-cardiovasculair

Torace-cardiovascolare
Torax-cardiovascular



2.7 mm



3.5 mm



2 mm

1.2 mm



08-330 18 cm, 7"
08-301 21 cm, 8 1/4"

2 mm



08-332 18 cm, 7"
08-303 21 cm, 8 1/4"

DEBAKEY

08-300 15 cm 6"
08-301 20 cm 8"
08-302 24 cm 9 1/2"
08-303 30 cm 12"

DEBAKEY

08-310 15 cm 6"
08-311 20 cm 8"
08-312 24 cm 9 1/2"
08-313 30 cm 12"

COOLEY

08-320 15 cm 6"
08-321 20 cm 8"
08-322 24 cm 9 1/2"
08-323 30 cm 12"

DE BAKEY



08-340 16 cm, 6 1/2" 1.5 mm
08-341 20 cm, 8" 1.5 mm
08-342 24 cm, 9 1/2" 1.5 mm



08-343 16 cm, 6 1/2" 2.0mm
08-344 20 cm, 8" 2.0mm
08-345 24 cm, 9 1/2" 2.0mm
08-346 30.5 cm, 12" 2.0mm



08-347 16 cm, 6 1/2" 2.7mm
08-348 20 cm, 8" 2.7mm
08-349 20 cm, 8" 2.7mm Heavy
08-350 24 cm, 9 1/2" 2.7mm
08-351 30.5 cm, 12" 2.7mm



08-352 16 cm, 6 1/2" 3.5mm
08-353 20 cm, 8" 3.5mm
08-354 24 cm, 9 1/2" 3.5mm
08-355 30.5 cm, 12" 3.5mm



08-370 16 cm, 6 1/2"

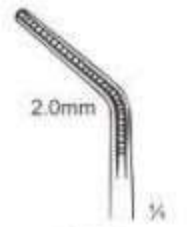

08-371 20 cm, 8"

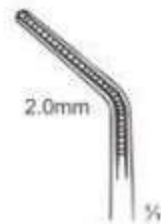

08-372 24 cm, 9 1/2"

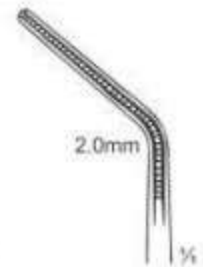

08-373 30 cm, 12"

DE BAKEY

DE BAKEY

THORACIC/CARDIOVASCULAR

Thorax-cardiovasculaire
Thorax-cardiovasculair

Torace-cardiovascolare
Torax-cardiovascular

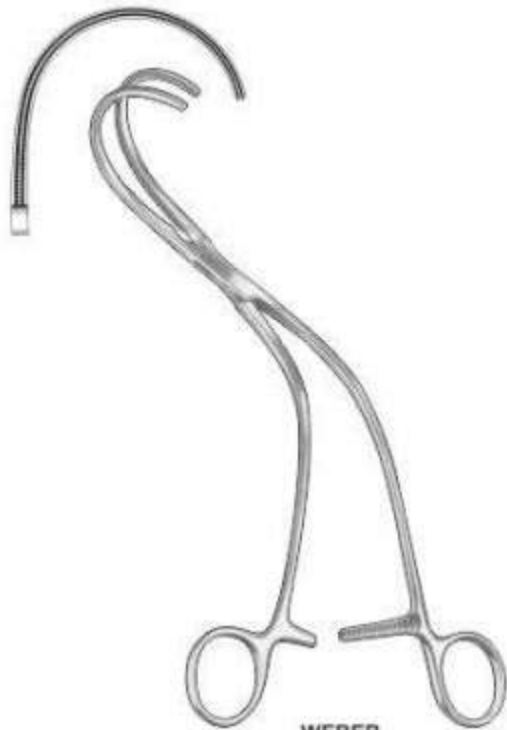

WEBER
08-380
26 cm, 10 1/4"
left



WEBER
08-390
26 cm, 10 1/4"
right

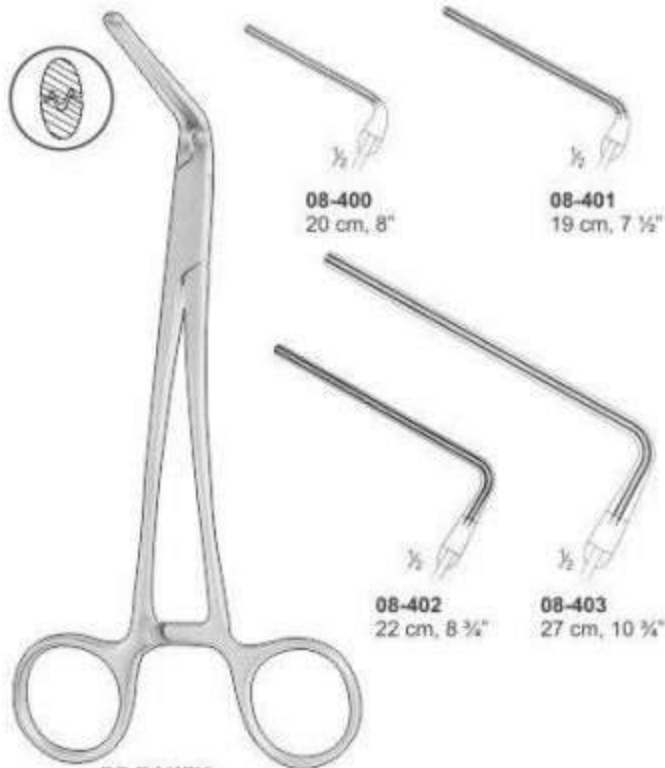

DE BAKAY
Right Angled Jaws

08-400
20 cm, 8"

08-401
19 cm, 7 1/2"

08-402
22 cm, 8 3/4"

08-403
27 cm, 10 1/4"



DE BAKAY

08-410
19 cm,
7 1/2"

08-411
25 cm,
10"

08-412
25 cm,
10"

08-413
25 cm,
10"

08-414
27 cm,
10 3/4"

THORACIC/CARDIOVASCULAR

Thorax-cardiovasculaire
Thorax-cardiovascular

Torace-cardiovascolare
Torax-cardiovascular

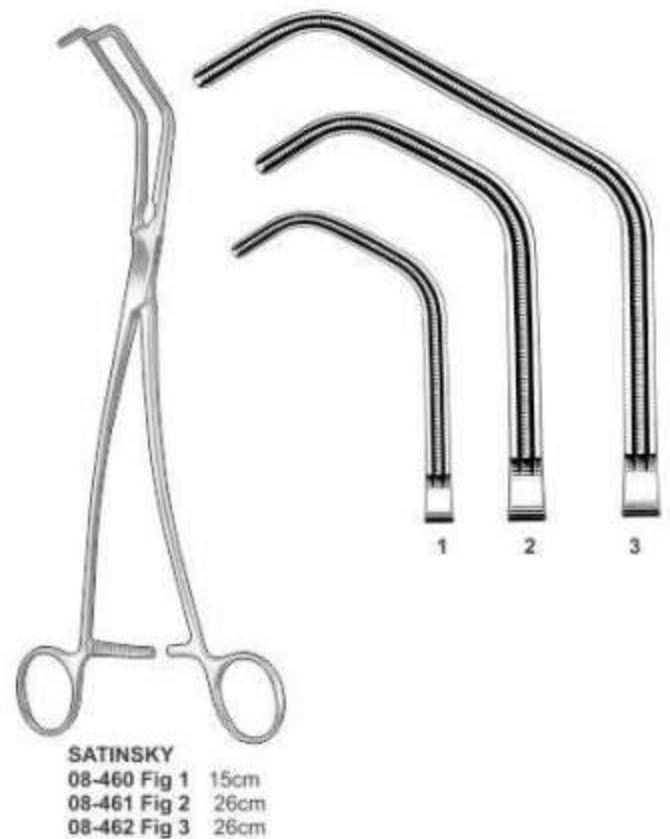
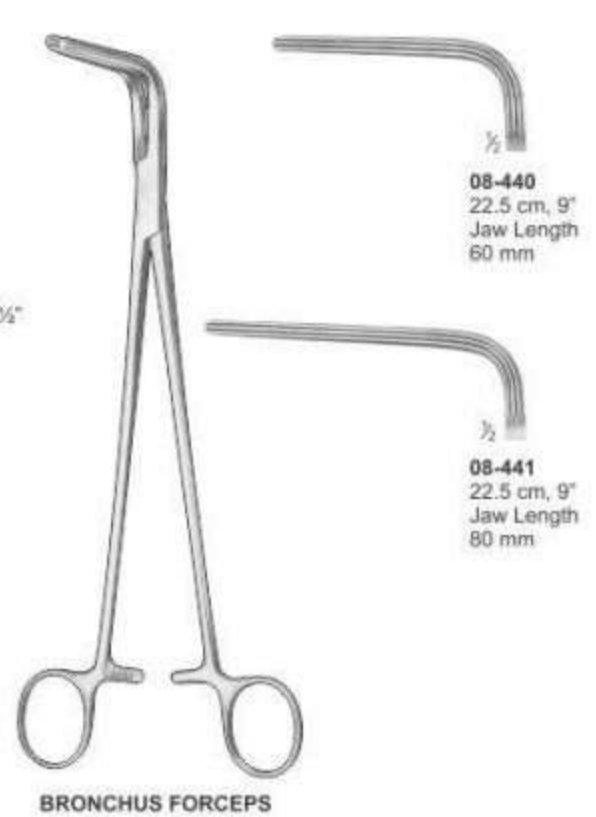
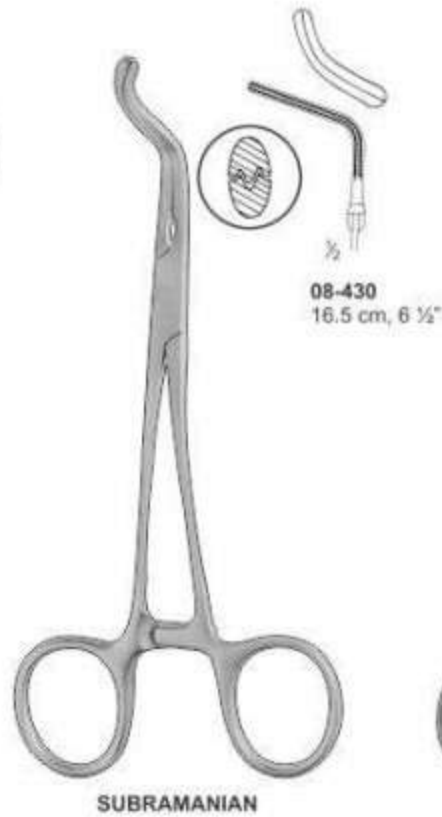

THORACIC/CARDIOVASCULAR

Thorax-cardiovasculaire
Thorax-cardiovasculair

Torace-cardiovascolare
Torax-cardiovascular

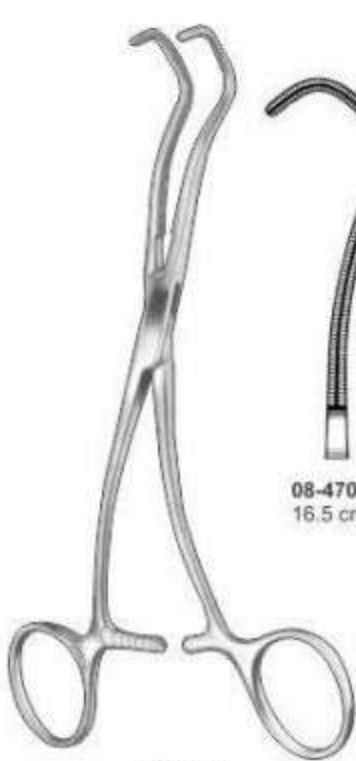

DERRA

08-470
16.5 cm, 6 1/2"

08-471
17 cm, 6 3/4"

08-472
18 cm, 7"

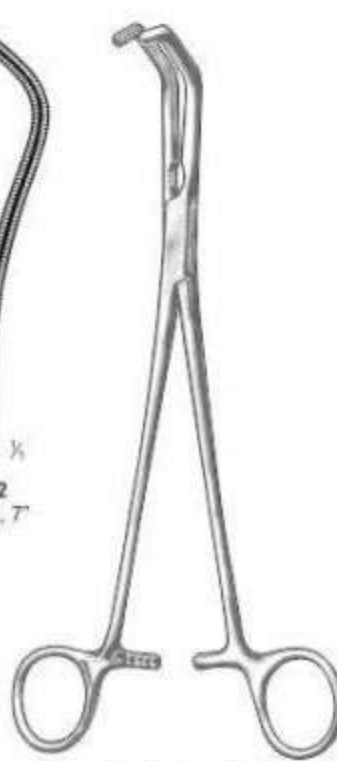

PRICE-THOMAS
08-480 22cm



WANGENSTEEN
08-490 28cm

LUNG GRASPING



LOVELACE
08-500 20cm

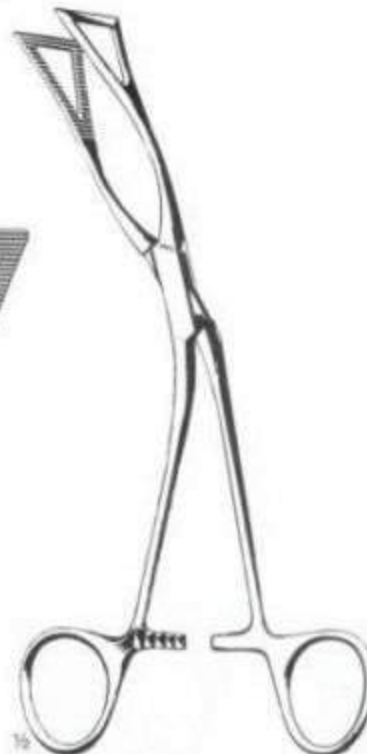

LOVELACE
08-510 20cm

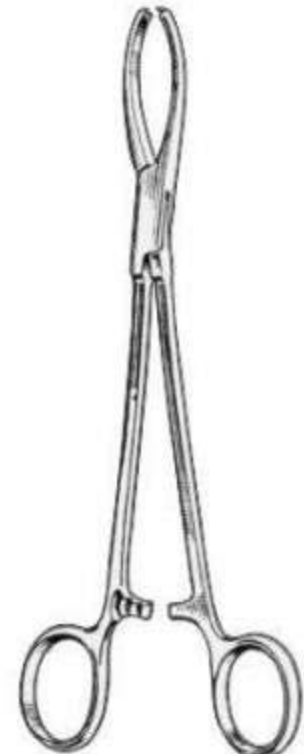

**HARRINGTON
ROCHESTER**
08-520 30cm

THORACIC/CARDIOVASCULAR

Thorax-cardiovasculaire
Thorax-cardiovasculaire

Torace-cardiovascolare
Torax-cardiovasculaire



DAVIDSON
08-530 23cm

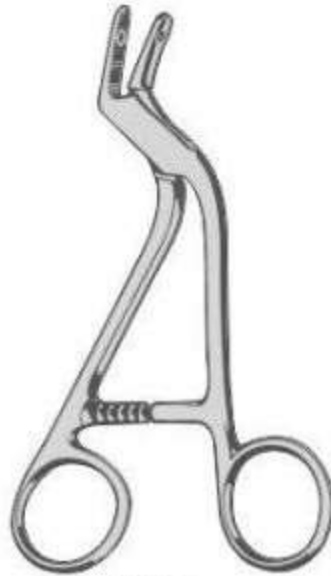

ADSON
08-540 15cm



BLALOCK
08-550 15cm
08-551 20cm
08-552 20cm

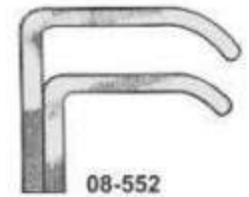

BAILEY-GIBBON
08-560
20 cm, 8"
For Adult



20 cm, 8"
For children



BAILEY-BABY
08-570
15 cm, 6"



SELLORS RIB CONTRACTOR
08-580
20 cm, 8"

RIB RETRACTORS

Rippensperrer
Separador costal

Ecarteur de côtes
Divaricatore costale

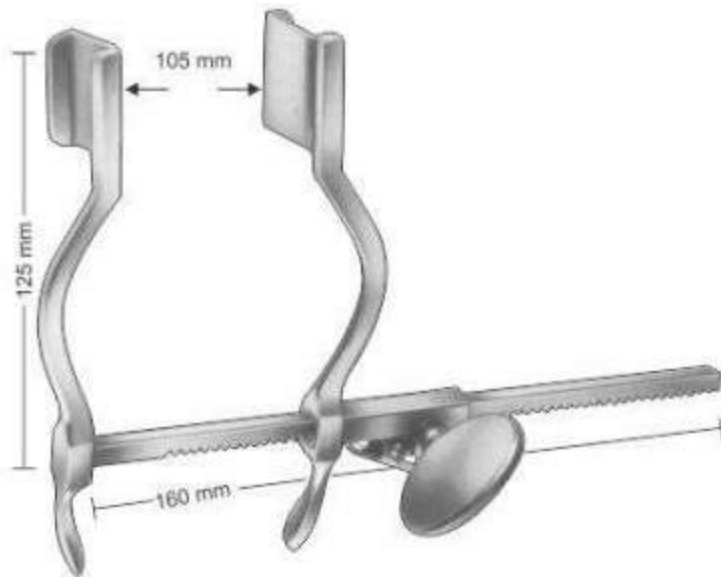

HERTZLER
08-590
blades 20 x 25 mm, spreading 105 mm

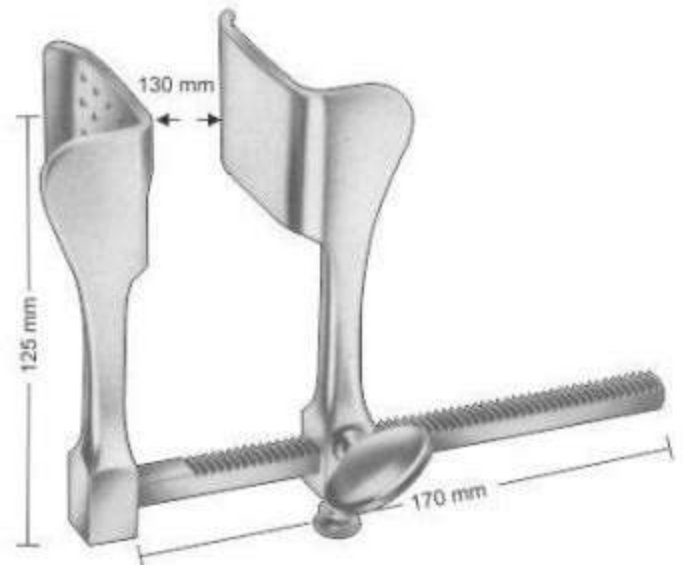

TUFFIER
08-600
blades 43 x 53 mm, spreading 130 mm



FINOCCHIETTO,
08-610
20 cm, 8"
08-611 30 mm x 45 mm spreading 150 mm
08-612 46 mm x 62 mm spreading 190 mm
08-613 80 mm x 65 mm spreading 190 mm



TUFFIER RIB RETRACTOR
08-620
lateral blades 45 x 45 mm,
spreading 160 mm

RIB SHEARS, STERNUM CHISEL

Rippenscheren, Sternummeißel
Costotomos, Cinceles

Costotomes, ciseau-Burin à sternum
Costotomi, Scalpello per sterno



SAUERBRUCH-FREY
08-630
for the first rib
37 cm, 14 1/2"



SCHUMACHER
08-640
sternum shears
21 cm, 8 1/4"



SAUERBRUCH
08-650 24 cm, 9 1/2" For Children,
08-651 27 cm, 10 3/4" For Adults,



SCHUARDT
08-660
17 cm, 6 3/4"



BONE SHEAR
08-670
23 cm, 9"



08-680
19 cm, 7 1/4"



RIB SHEAR
08-690
23 cm, 9"



GLUCK
RIB SHEAR
08-700
22 cm, 8 3/4"



COLLIN
08-710
19 cm, 7 1/4"

RIB SHEARS, STERNUM CHISEL

Rippenscheren, Sternummeißel
Costotomos, Cinceles

Costotomes, ciseau-Burin à sternum
Costotomi, Scalpello per sterno



DOYEN
08-720
19 cm, 7 1/4"



LEBSCHÉ
STERNUM CHISEL
08-730
24.5 cm, 9 3/4"



SEMB
08-740
20 cm, 8"



SEMB
08-750
20 cm, 8"



GIERTZ-STILLE
08-760
27 cm, 10 1/2"

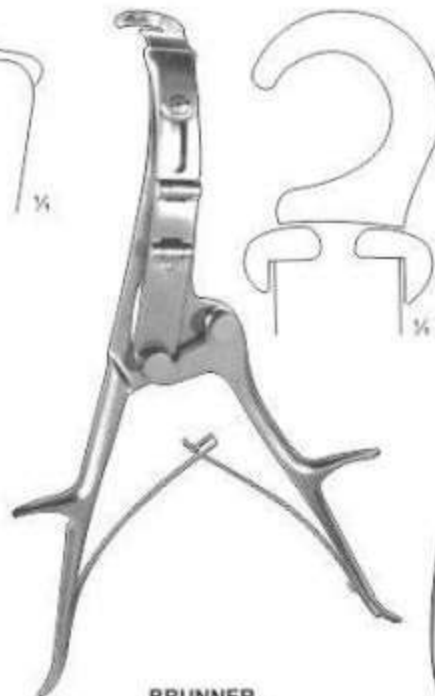

BRUNNER
08-770
33.5 cm, 13"



MAURER-COLLIN

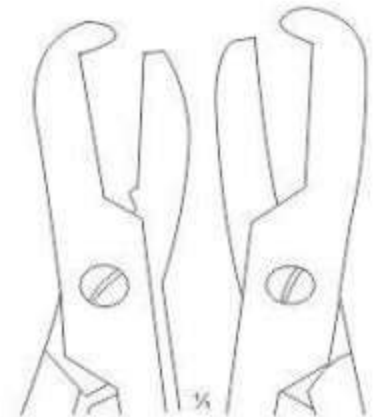

08-780
Hooked Left
23 cm, 9"

08-781
Hooked Right
23 cm, 9"

AMPUTATION SAW

Amputationssägen
Sierras de amputación

Scies à amputation
Seghe per amputazione

BONE DRILLS

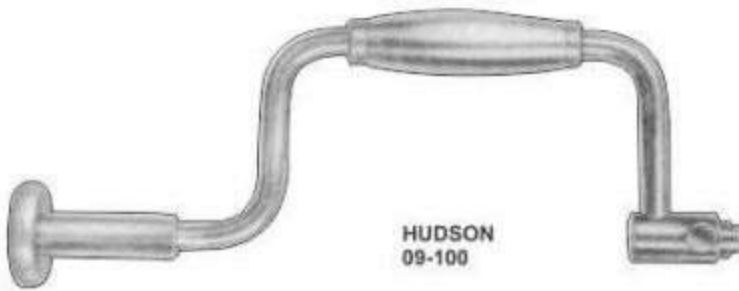

HUDSON
09-100



Fig. 1
09-105



Fig. 2
09-110



Fig. 3
09-115



CUSHING
09-120



09-125



GIGLI SAW
09-130 30 mm
09-131 40 mm
09-132 50 mm
09-133 70 mm
stainless



GIGLI HANDLE
09-140



**ENGEL
PLASTER SAW**
09-150
15.5 cm, 6"



POST MORTEN
09-160
20 cm, 8"



CHARRIERE
09-170 25 cm, 10"
09-171 27 cm, 10 1/2"
Double saw



CHARRIERE
09-180 27 cm, 10 1/2"
09-181 30 cm, 12"



CHARRIERE
09-190
35 cm, 13 1/4"



SATTERLEE
09-200
31cm, 12 1/4"



PERCY RETRACTOR
09-210

BONE HOLDING FORCEPS

Repositionszangen
Pinzas para reposición

Pinces à réduction
Pinze per riposizioni



09-220



SEQUESTRUM
09-220 27cm
09-221 29cm



09-221



VAN BUREN
09-230 27cm

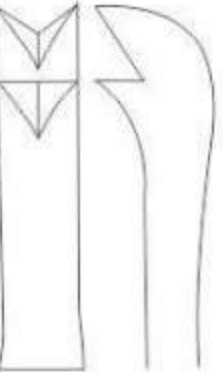

heavy pattern

FERGUSSON
BONE HOLDING
FORCEPS
09-240
21cm



LANGENBECK BONE
HOLDING FORCEPS
09-250
21cm



SEMB BONE
HOLDING FORCEPS
09-260
19cm

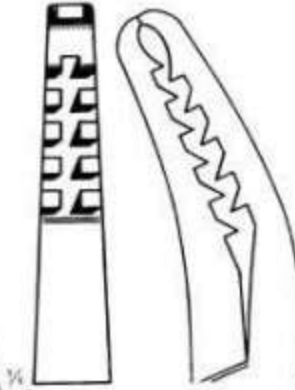

curved sideways



FARABEUF BONE
HOLDING FORCEPS
09-270 23cm
09-271 26cm

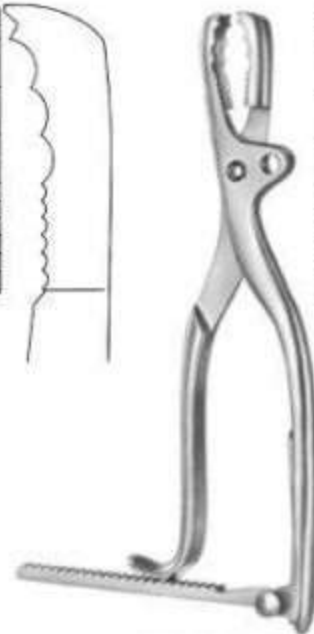
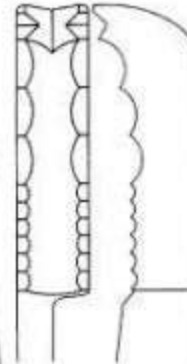

FARABEUF BONE
HOLDING FORCEPS
09-280
26cm

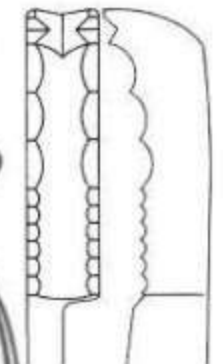

BONE HOLDING FORCEPS

Repositionszangen
Pinzas para reposición

Pinces à réduction
Pinze per riposizioni



Lane Bone Holding Forceps
09-290 31.5cm
09-291 39cm



Lane Bone Holding Forceps
09-300 33cm
09-301 45cm

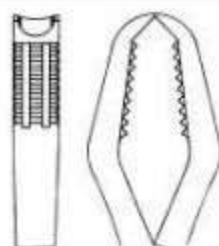

without ratchet

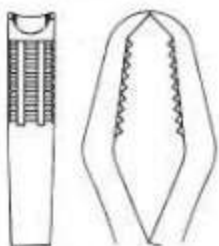

with ratchet



Kern Bone Holding Forceps
09-310 17cm
29-311 21cm



Kern Bone Holding Forceps
09-320 17cm
09-321 21cm



Lambotte Bone Holding Forceps
09-330 19cm
09-331 23cm
09-332 26cm



Lambotte Bone Holding Forceps
09-340 22cm
09-341 26cm
09-342 33cm



VERBRUGGE
09-350
18 cm, 7"



VERBRUGGE
09-360
18 cm, 7"



VERBRUGGE
09-370 25 cm, 10"
09-371 26 cm, 10 1/4"
09-372 27 cm, 10 1/2"



VERBRUGGE
09-380 25 cm, 10"
09-381 26 cm, 10 1/4"
09-382 27 cm, 10 1/2"



VERBRUGGE
09-390
18 cm, 7"



VERBRUGGE
09-400 25 cm, 10"
09-401 26 cm, 10 1/4"
09-402 27 cm, 10 1/2"



REIL
09-410
17 cm, 7"



REDUCTION FORCEPS
09-420
20 cm, 8"
with Points



09-430 17 cm, 7"
For fingers, with drill
Guide for Kirschner
Wires up to 1 mm

BONE HOLDING FORCEPS, REPOSITION FORCEPS

Knochenfasszange, Repositionszangen
Pinzas para hueso, Pinzas para reposición

Daviers porte-so, Pincas à réduction
Tenaglie per ossa, Pinze per riposizioni

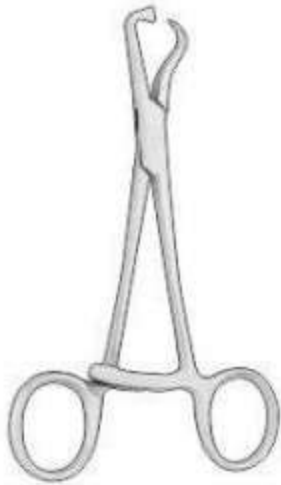

HOLDING FORCEPS
09-440
13 cm, 5"



RATCHET FIXATION FORCEPS
09-450
14.5 cm, 6"



MALLEOLAR FORCEPS
09-460
20 cm, 8"

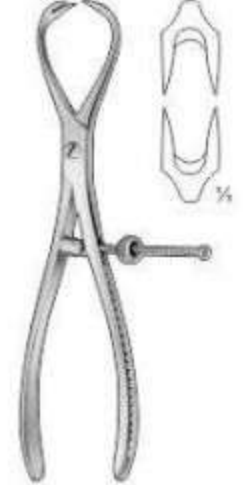

PATELLA FORCEPS
09-470
18.5 cm, 7 1/4"



REDUCTION FORCEPS
09-480 16 cm, 6 1/2"
09-481 24 cm, 9 1/2"
with Thread Lock

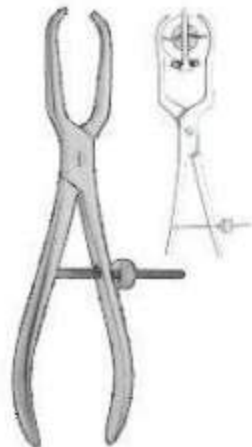

REPOSITION FORCEPS
09-490
23 cm, 9"



LOWMANN BONE CLAMP
09-500 18.0 cm, 7"
09-501 20.0 cm, 8"
09-502 22.0 cm, 8 1/2"



LOWMAN-HOGLUND
09-510
17.5 cm, 7"

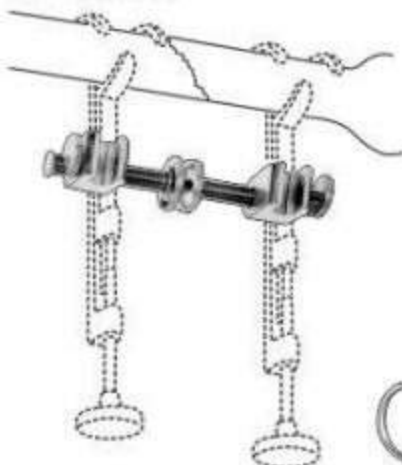

GERSTER
09-520 18 cm, 7"
09-521 20 cm, 8"
09-522 22 cm, 9"



LEWIN

09-530
17.5cm, 7"



ORTHO FORCEPS
09-540 13 cm, 5"

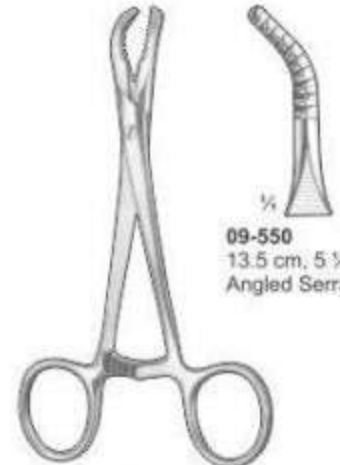

09-550
13.5 cm, 5 1/2"
Angled Serrated

MALLETS

Hämmer
Martillos

Mallets
Martelli



plane (nylon)
convex (steel)
plastic handle
Head 30mm Ø
Weight 675 Gr.

MALLET
09-560
26 cm, 10 1/2"



plastic handle
Head 42 / 30mm Ø
Weight 530 Gr.

MALLET
09-570
26 cm, 10 1/4"



plastic handle
Head 30mm Ø
Weight 480 Gr.

MALLET
09-580
24 cm, 9 1/2"



Plastic Handle
Head 30mm Ø
Weight 510 Gr.

MALLET
09-590
26 cm, 10 1/4"



disks and plastic handle
Head 37mm Ø
Weight 370 Gr.

MALLET
09-600
22.5 cm, 9"

Spare Facing (pair)
Pi09-448-00
Plastic



made of plastic
Head 30mm Ø
Weight 125 Gr.

MALLET
09-610
18 cm, 7"



made of plastic
with lead filling
Head 42mm Ø
Weight 400 Gr.
Head 42mm Ø
Weight 250 Gr.

MALLET
09-620
26 cm, 10 1/4"



made of plastic
with lead filling
Head 42mm Ø
Weight 250 Gr.

MALLET
09-630
26 cm, 10 1/4"



09-641
Head 26 mm Ø
Weight 300 Gr.
09-642
Head 28 mm Ø
Weight 340 Gr.
09-643
Head 30 mm Ø
Weight 400 Gr.

WILLIGER
09-640
24 cm, 9 1/2"

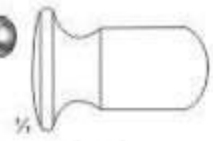

09-651
Head 25 mm Ø
Weight 120 Gr.
09-652
Head 30 mm Ø
Weight 180 Gr.
09-663
Head 35 mm Ø
Weight 260 Gr.

DOYEN
09-650
21 cm, 8 1/2"

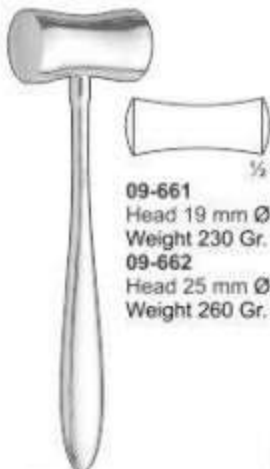

09-661
Head 19 mm Ø
Weight 230 Gr.
09-662
Head 25 mm Ø
Weight 260 Gr.

LUCAE
09-660
19 cm, 7 1/2"



WILLIGER
09-670
16.5 cm, 6 1/2"
Head 20 mm Ø
weight 140 Gr.



PARTSCH
09-680
18 cm, 7"



09-692
with interchangeable
Plastic disks
Head 26 mm Ø
Weight 320 Gr.

MEAD
09-690
17 cm, 6 1/2"



for ulnar head
prosthesis
plastic handle
Head 25mm Ø
Weight 300 Gr.

HERBERT
09-700
19 cm, 7 1/2"



nylon disks
plastic handle
Head 25mm Ø
Weight 300 Gr.

VICKERS
09-710
19 cm, 7 1/2"

MALLETS

Hämmer
Martillos

Maillets
Martelli

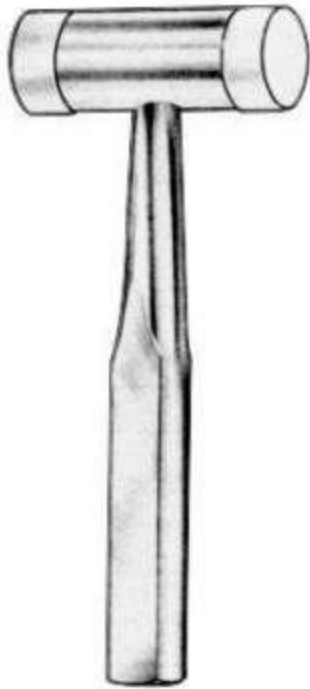

ORTHO / WITH PLASTIC CAPS
09-720
18 cm, 7"
25 mm Dia.
(140g)
Pair of spare disks
with interchangeable
plastic disks



ORTHO
09-730
26.5 cm, 10 1/2"
(450g)



**ORTHOAEDIC
MALLET**
09-740
19 cm, 7 1/2"



HAJEK
09-750
22 cm, 8 3/4"
27 mm Dia.
(140g)



ORTHO
09-760
26.5 cm
(450g)



BERGMANN
09-770
24 cm, 9 1/2"
(300g)



GERZOG
09-780
18 cm, 7"
(240g)



OMBREDANNE
09-790
24 cm, 9 1/2"
40 mm dia (550g)



COTTLE
09-800
19 cm, 7 1/2"
(240g)



COLLIN
09-810
20 cm, 8"
30 mm dia
220 g



HEATH
09-820
16 cm
Head 4.5 cm Dia.
Weight 793 Gr.

BONE CURETTES

Scharfe Löffel
Cucharillas cortantes

Curettes tranchantes
Curette taglianti

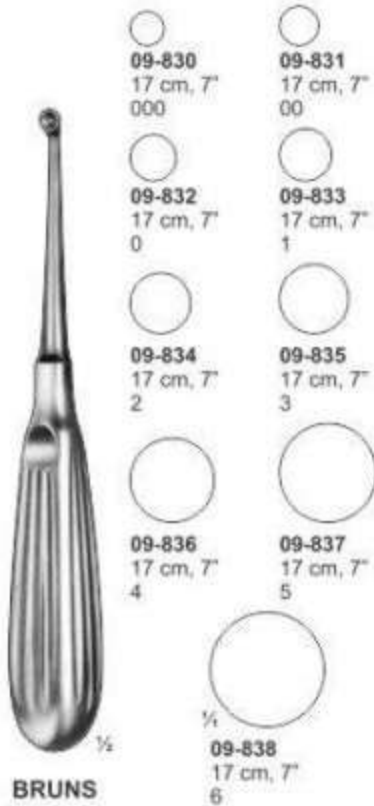

BRUNS

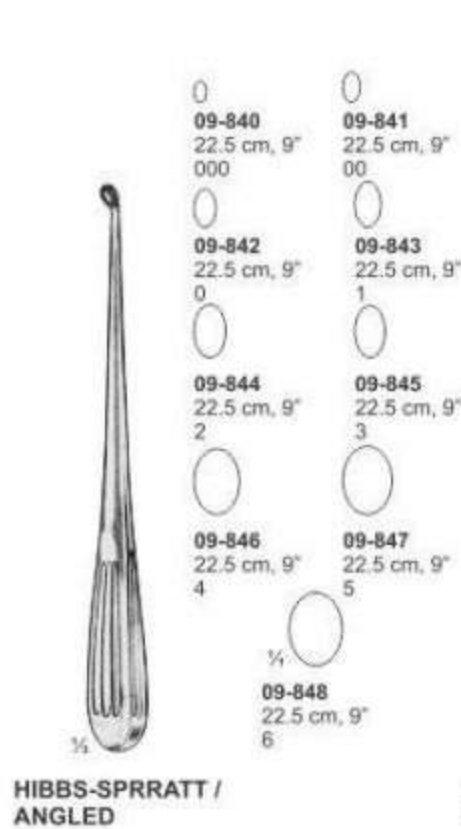

HIBBS-SPRATT / ANGLED

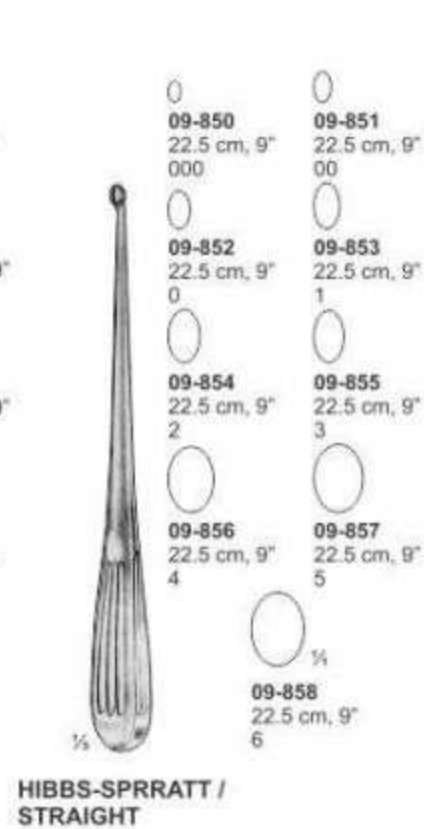

HIBBS-SPRATT / STRAIGHT



WILLIGER

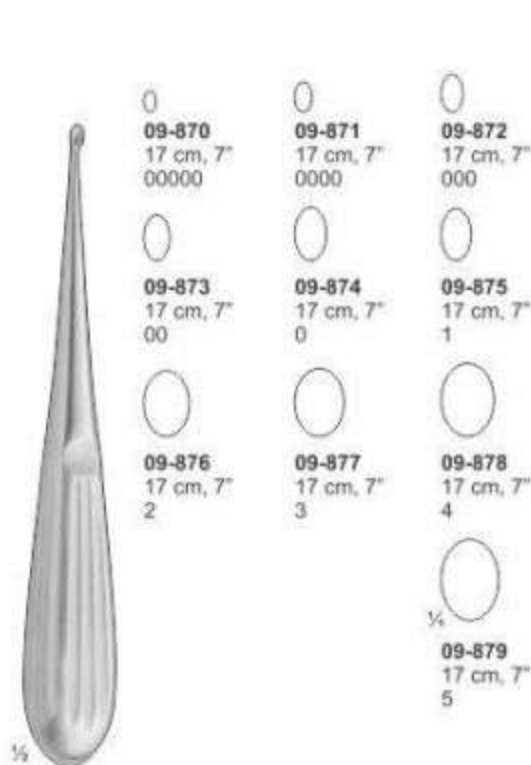

SPRATT / HOLLOW HANDLE

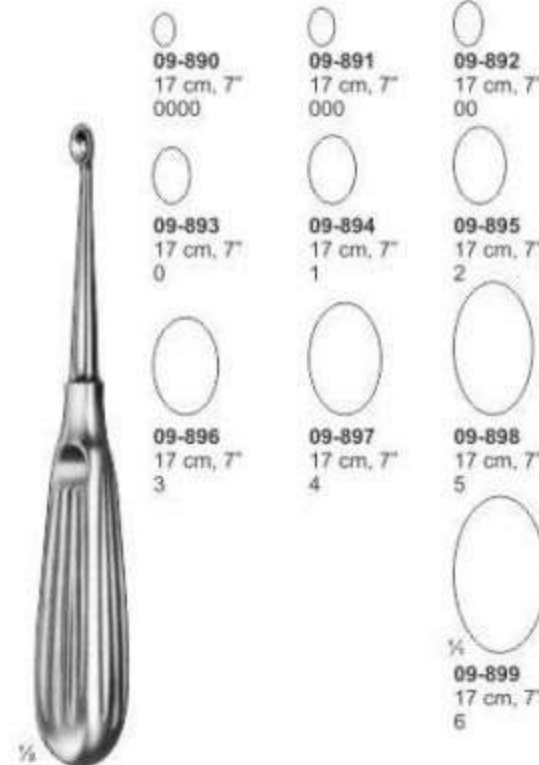

VOLKMANN

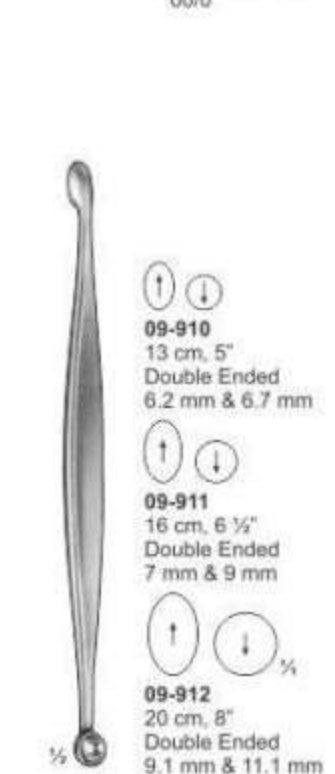

VOLKMANN

BONE CURETTES

Scharfe Löffel
Cucharillas cortantes

Curettes tranchantes
Curette taglianti



09-920 To
09-923
25 cm, 10"



UFFENORDE Left
09-930
17.5 cm, 7"



UFFENORDE Right
09-940
17.5 cm, 7"



SIMON
24 cm, 9 1/2"

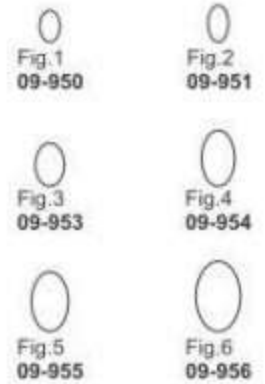

BRUNS
23 mm, 9"

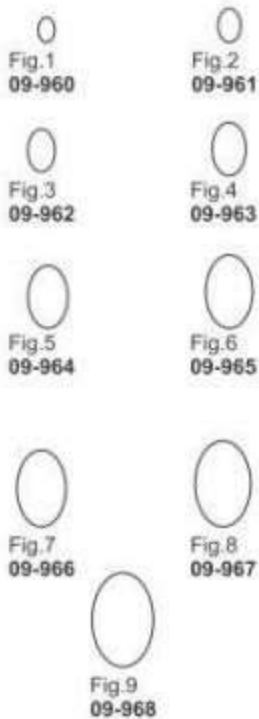

WILLIGER
13.5 cm, 5 1/4"



MARTINI
13.5 cm, 5 1/4"



JANSEN
09-990
16 cm, 6 1/4"



JANSEN
09-1000
15 cm, 6"

BONE CURETTES, DOUBLE-ENDED

Scharfe Doppellöffel
Cucharillas de doble extremo

Curettes doubles
Curette doppia



09-1010
21 cm, 8 1/4"



VOLKMANN



09-1020
13 cm, 5 1/4"

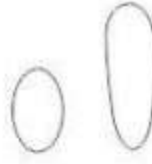

09-1021
14 cm, 5 1/4"



09-1022
17 cm, 6 1/4"



VOLKMANN



09-1030
13 cm, 5 1/4"

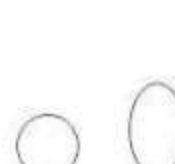

09-1031
16 cm, 6 1/4"



09-1032
20 cm, 8"



SPRATT

0
Fig. 0000
09-1040

0
Fig. 00
09-1042

0
Fig. 1
09-1044

0
Fig. 3
09-1046

0
Fig. 5
09-1048

0
Fig. 000
09-1041

0
Fig. 0
09-1043

0
Fig. 2
09-1045

0
Fig. 4
09-1047



BRUNS

Fig. 0000
09-1050

Fig. 0
09-1053

Fig. 3
09-1056

Fig. 000
09-1051

Fig. 1
09-1054

Fig. 4
09-1057

Fig. 00
09-1052

Fig. 2
09-1055

Fig. 5
09-1058

Fig. 6
09-1059



FIBER HANDLE
27 cm, 10 3/4"

Fig. 0
09-1070

Fig. 1
09-1071

Fig. 2
09-1072

Fig. 3
09-1073



SCOVILLE
25 cm, 10"



09-1080
Straight

09-1081
Down Angle

09-1083
Up Angle

REAMER, ELEVATORS, BONE FILES & ALVEOTOMY FILES

Reibahien, Elevatorien, Knochenfeilen, Alveotomiefeilen

Pointes-carrées, Elévateurs, Limes à os, Limes pour alvéolotomie

Escariadores, Elevadores, Limas para huesos, Limas para alveolotomía

Punteruoli, Elevatori, Lime per ossa, Lime per alveolotomia



09-1090
14 cm, 5 1/2"

09-1100
14 cm, 5 1/2"

PERTHES
09-1110 16 cm, 6 1/4"
09-1111 22 cm, 8 3/4"

BONE HOOK
09-1120
23 cm, 9"
3 cm Dia.

PUTTI
09-1130
27 cm, 10 1/2"

PUTTI
09-1140
30 cm, 12"

BONE TAMPS
09-1150
15.4 cm, 6"



FOMAN RASP
09-1160
21 cm, 8 1/2"



MILLER-COLBURN
BONE FILE
09-1170
18 cm, 7"

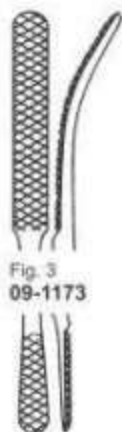

MILLER
ALVEOTOMY FILE
09-1180
19 cm, 7 1/2"



MILLER
ALVEOTOMY FILE
09-1190
19 cm, 7 1/2"

OSTEOTOMES, GOUGES

Osteotome, Hohlmeißel
Osteótomos, Gubias

Ostéotomes, Gouges
Osteotomi, Sgorbie



SMITH PETERSON
20 cm, 8"

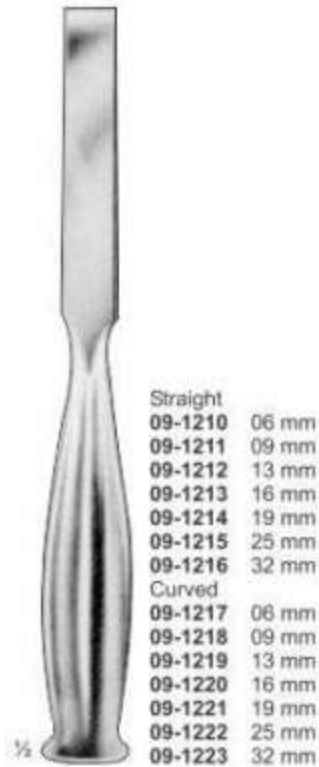

SMITH PETERSON
20 cm, 8"



STILLE
20 cm, 8"

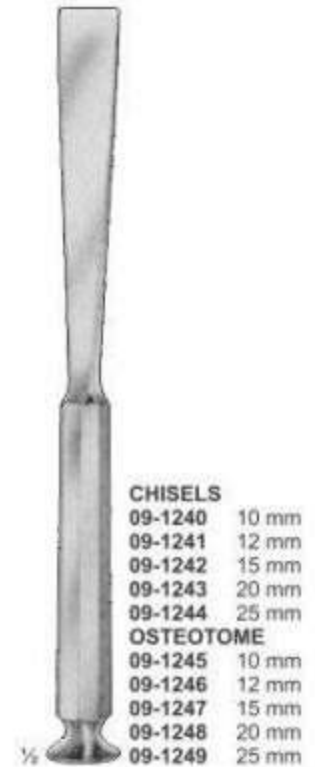

STILLE
20 cm, 8"

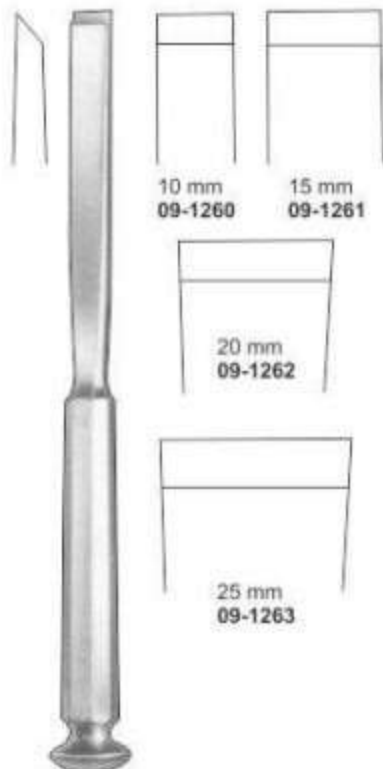

STILLE
09-1260 – 09-1263
20 cm, 8"

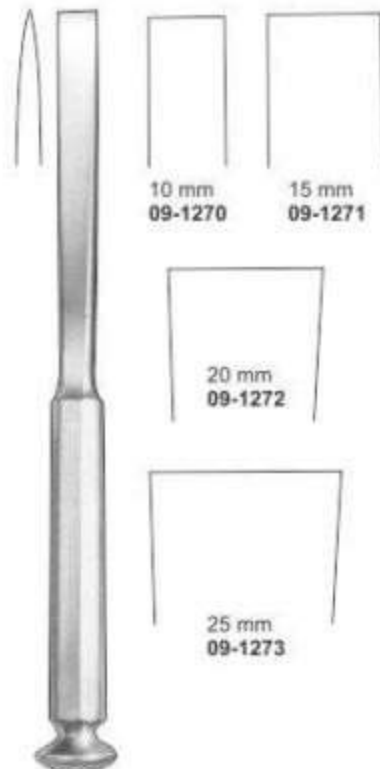

09-1270 – 09-1273
20 cm, 8"

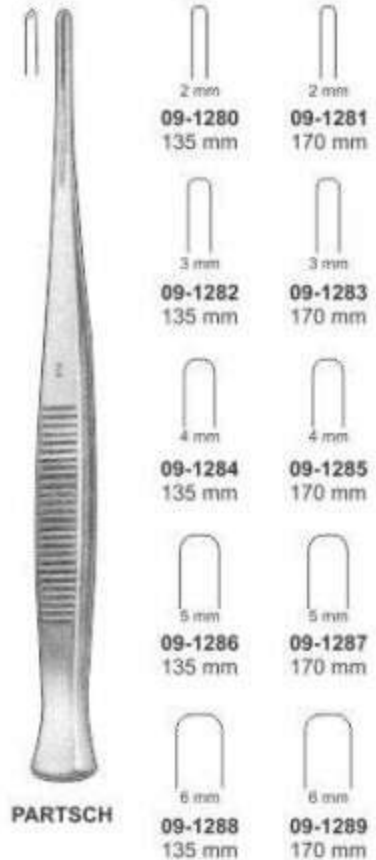

PARTSCH

OSTEOTOMES, GOUGES

Osteotome, Hohlmeißel
Osteótomas, Gubias

Ostéotomes, Gouges
Osteotomi, Sgorbie



09-1300 Straight 5 mm
09-1301 10 mm
09-1302 15 mm



09-1310 Curved 5 mm
09-1311 10 mm
09-1312 15 mm



MINI-LAMBOTTE
12.5 cm, 5"

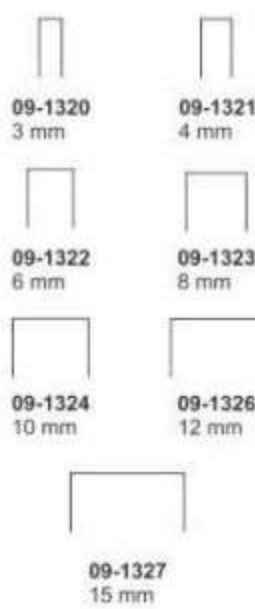

MINI LAMBOTTE
17 cm, 6 3/4"

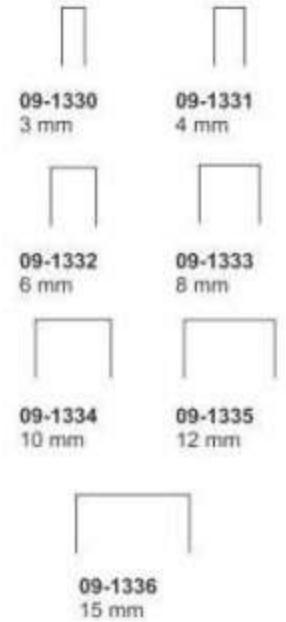

ALEXANDER



LAMBOTTE
24 cm, 9 1/2"

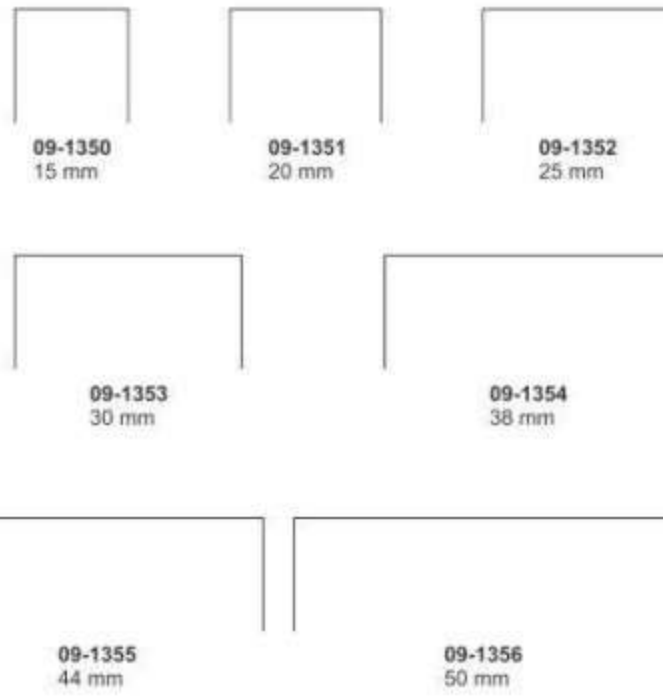

LAMBOTTE
23 cm, 9"

09-1360 15 mm
09-1361 20 mm
09-1362 25 mm
09-1363 30 mm
09-1364 38 mm
09-1365 44 mm
09-1366 50 mm

PERIOSTEAL ELEVATORS

Raspatorien
Periostótomos

Rugines-raspatoires
Periostotomi



PERIOSTEAL Elevator 09-1370
18.2 cm, 7"
Fiber/Phenolic Handle
blade 6mm



CHANDLER Bone Elevator

09-1380
19 cm, 7 1/2" 13 mm
09-1381
20 cm, 8" 20 mm
09-1382
23 cm, 9" 25 mm
09-1383
25 cm, 10" 31 mm



HOEN PERIOSTEAL Elevator 09-1390
16.5 cm, 6 1/2"



KEY PERIOSTEAL Elevator 09-1400
18 cm, 7 1/2"



KEY (Fig. A)

Fig.	Item	Description	Inch.	Width
A	09-1410	19 cm	7 1/2"	3 mm
A	09-1411	19 cm	7 1/2"	6 mm
A	09-1412	19 cm	7 1/2"	9 mm
A	09-1413	19 cm	7 1/2"	12 mm
A	09-1414	19 cm	7 1/2"	15 mm
A	09-1415	19 cm	7 1/2"	19 mm
A	09-1416	19 cm	7 1/2"	25 mm



COBB Elevators 09-1420
23.4 cm, 9"
Hex Handle

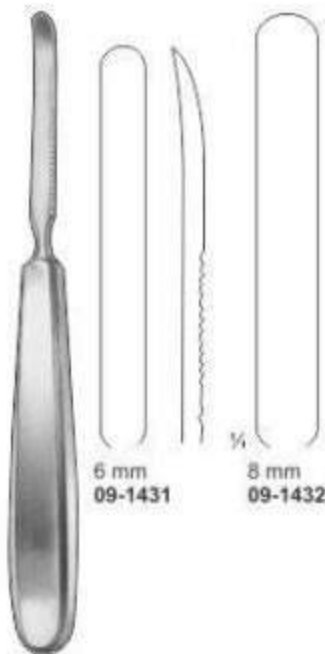

PERIOSTEAL ELEVATOR 09-1430
17 cm, 7"



DOYEN RIB RASPATORY 09-1440
17 cm, 7"

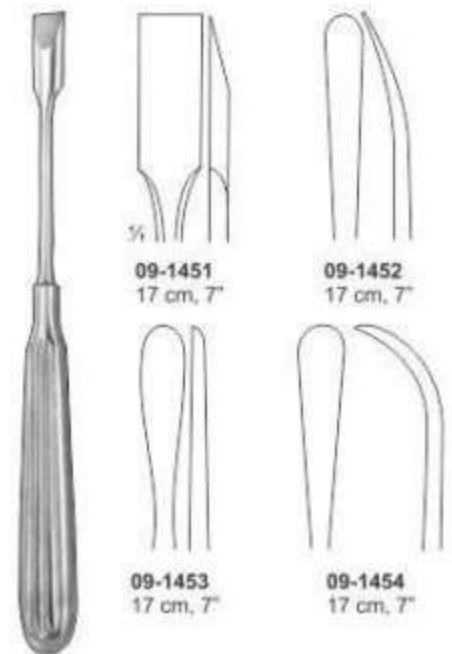

ADSON ELEVATOR 09-1450
17 cm, 7"

PERIOSTEAL ELEVATORS

Raspatorien
Periostótomos

Rugines-raspatoires
Periostotomi



09-1460
20 cm, 8"
Medium straight
blade round edge,
width 14 mm



09-1470
20 cm, 8"
Medium curved
blade round edge,
width 14 mm



09-1480
18 cm, 7"
Small curved
blade round edge,
width 6 mm



09-1490
18 cm, 7"
Small curved
blade straight edge,
width 6 mm



09-1500
18 cm, 7"
Extra small
curved blade
round edge,
width 3 mm



09-1510
20 cm, 8"
large straight blade
round edge,
width 20 mm



Medium Blade
Straight Edge, 14 mm
09-1520
Straight 18.5 cm, 7 1/2"
09-1521
Curved 18.5 cm, 7 1/2"



LANGENBECK
09-1530
18 cm, 7"



LANGENBECK
09-1540
19 cm, 7 1/2"



LAMBOTTE 21 cm, 8 1/2"
09-1550 1.0 cm
09-1551 1.5 cm
09-1552 2.0 cm



FARABEUF
09-1560
15 cm, 6"



FARABEUF
09-1570
15 cm, 6"



09-1580 5 mm
09-1581 6 mm
09-1582 7 mm
09-1583 18 cm, 6 1/2"

BONE LEVERS, KNEE RETRACTORS & SPINAL RETRACTORS

Knochenhebel, Kniehaken, Spinalhaken
Elevadores para hueso, Separadores para le genou,

Leviers à os, Ecarteurs pour le genou, Ecarteurs spinaux
Elevatori per ossa, Divaricatori per il ginocchio,



AUFRANC
09-1590
29 cm, 11 1/2"



AUFRANC
09-1600
29 cm, 11 1/2"



AUFRANC
09-1610
29 cm, 11 1/2"



**BLOUNT KNEE
RETRACTOR**
09-1620
17.5 cm, 7"



BENNETT
09-1630
24 cm, 9 1/2"
43 mm, 60 mm,
65 mm,

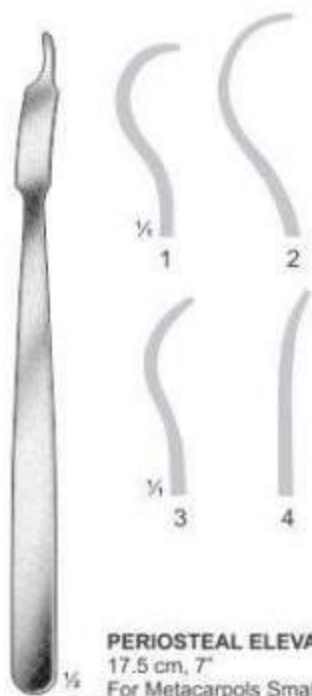

PERIOSTEAL ELEVATOR
17.5 cm, 7"
For Metacarpals Small
6 mm width
09-1640
For Metacarpals Medium
10 mm width
09-1641
Light Curve, Rounded End,
5 mm width
09-1642
Contra Angled Curve
4.5 mm width
09-1643

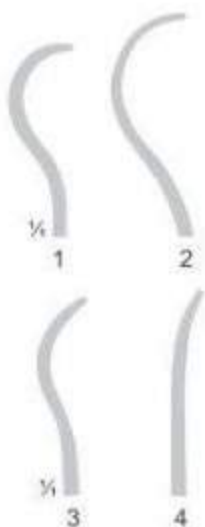

09-1650
18 cm, 7"
Small, width 6 mm
short, narrow tip



09-1660
18 cm, 7"
Small, width 8 mm
short, narrow tip



09-1670
12.5 cm, 5"
For Small Fragments
Board Shank



09-1680
20 cm, 8"
Width 8 mm
short, narrow tip



09-1690 20 cm, 8"
Width 18 mm short,
narrow tip
09-1691 20 cm, 8"
Width 18 mm long,
narrow tip

BONE LEVERS, KNEE RETRACTORS & SPINAL RETRACTORS

Knochenhebel, Kniehaken, Spinalhaken

Elevadores para hueso, Separadores para le genou,

Leviers à os, Ecarteurs pour le genou, Ecarteurs spinaux

Elevatori per ossa, Divaricatori per il ginocchio,



HOHMANN
09-1700
15 cm, 6"

HOHMANN
09-1710
15.4 cm, 6"
Short tip

09-1720 18 cm, 7"
Width 43 mm
narrow tip
09-1721 18 cm, 7"
Width 70 mm
narrow tip

09-1730
18 cm, 7"
Width 43 mm
long shank,
angled

09-1740
16 cm, 6 1/2"
width 22 mm
wide tip

09-1750
16 cm, 6 1/2"
long wire tip
for Hip Surgery,
width 24 mm

LANGE-HOHMANN
09-1760 27cm
09-1761 29cm

LANGE-HOHMANN
09-1770 24 cm, 9 1/2"
09-1771 26 cm, 10 1/2"
09-1772 29 cm, 11 1/2"

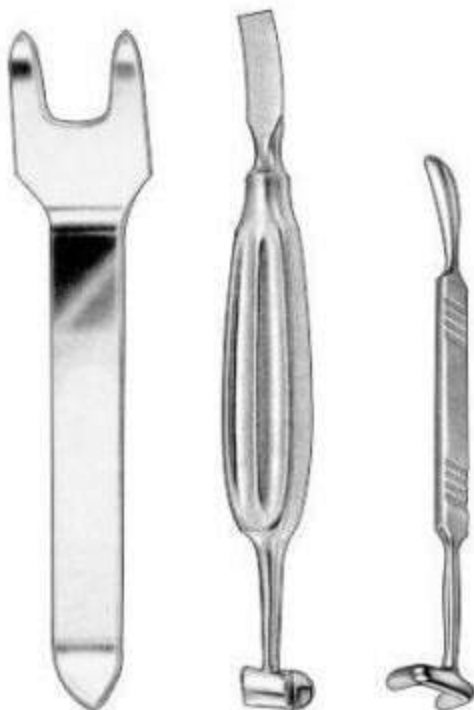

RETRACTOR
FOR KNEE
09-1780
27 cm, 11" Blunt

ALEXANDER
09-1790
20 cm, 8"

MATSON
09-1800
22 cm, 9"



LANGENBECK
ELEVATOR
09-1810
19.5cm

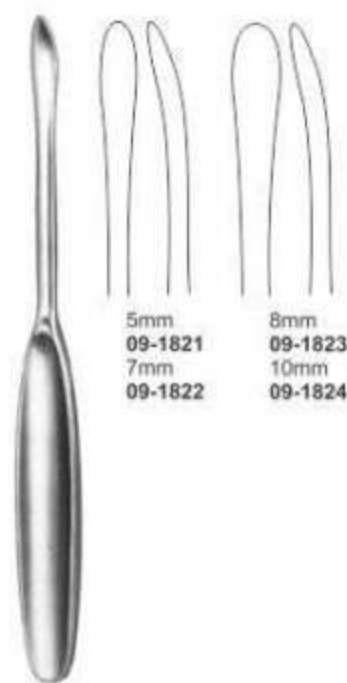

MARTIN-LANGENBECK
ELEVATOR
09-1820
17cm



Williger
Elevator
09-1830
17cm

Williger
Elevator
09-1840
17cm

ORTHOPAEDICS

Orthopädie
Ortopedia

Orthopédie
Ortopedia



09-1850 09-1851 09-1852 09-1853 09-1854 09-1855 09-1856

Semb



**NAIL EXTRACTING
FORCEPS**
09-1860
14 cm, 5 1/2"

**NAIL EXTRACTING
FORCEPS**
09-1870
14.5 cm, 5 3/4"

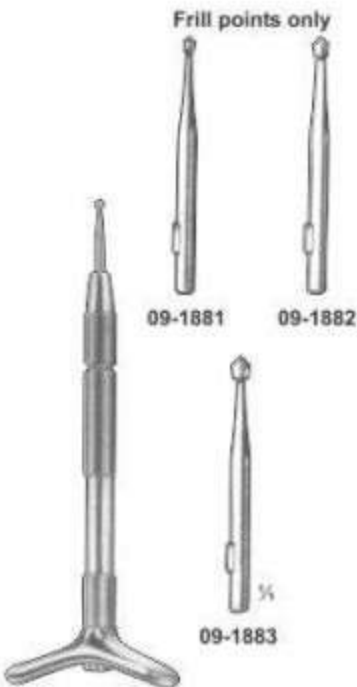

Frill points only

09-1881 09-1882

09-1883

09-1880
Finger nail drill with 3
drill points



**NAIL SPLITTING
FORCEPS**
09-1890
13.5 cm, 5 1/4"



RING CUTTER
09-1900
17 cm, 6 3/4"



09-1901
Saw Blade Only
for 09-1900



RING CUTTER
09-1910
17 cm, 6 3/4"



09-1911
Saw Blade Only
for 09-1910

FLAT NOSE PLIERS, TENDON TUNNELLING FORCEPS

Flachzangen, Sehnendurchzugzangen

Alicates de pico plano, Pinzas para pasar tendones

Pinces plates, Pinces pour passer les tendons

Tenaglie piatte, pinze passa-tendini



09-1920
14 cm, 5 1/2"
Cross serrated

NEEDLE
NOSE PLIERS



09-1930
19 cm, 7 1/2"
Serrated

NEEDLE
NOSE PLIERS



FLAT NOSE
09-1940
18 cm, 7"



09-1950
15.25 cm, 6"
6 mm

TENDON



BRAND
09-1960 15 cm, 6"
09-1961 19 cm, 7 1/2"
09-1962 24 cm, 9 1/2"



BRAND
09-1970 15 cm, 6"
09-1971 19 cm, 7 1/2"
09-1972 24 cm, 9 1/2"



CARROLL
09-1980
13 cm, 5"
Curved Shaft
2 mm x 6 mm



LEAD HAND
09-1990
Adult Size



FLAT NOSED
PARALLEL PLIERS
09-2000 18 cm, 7"
with lateral wire cutter

FLAT NOSE, COMBI-FLAT, VISE GRIP PLIERS

Flachzangen, Tonnenzange, Kombinationszange
Alicates de pico plano, Combi-Alicate de alambre

Pinces plates, Combi-Pince pour fils
Tenaglie piatte, Combi-Pinza per fili



09-2010
17 cm, 6 1/2"
Grooved, Serrated

**FLAT NOSED
PARALLEL PLIERS**



09-2020
18 cm, 7"
With Spring
serrated

LOCKING PLIERS



FLAT NOSED PLIER
09-2030 18 cm, 7"
parallell, with lateral
wire cutter



LOUTE
09-2040
21 cm, 8 1/2"



09-2050
23 cm, 9"
3 Prong

MODEL USA



09-2060
19.5 cm, 8"

SLIP JOINT



KIRSCHNER
09-2070 40 x 140 mm
09-2071 60 x 220 mm



KIRSCHNER, AMERICAN TYPE
09-2080 Medium 130 mm
09-2081 Large 185 mm
09-2082 Extra Large 220 mm
Max. Jaw Opening



KIRSCHNER
09-2090 200 mm x 155 mm
09-2091 155 mm x 155 mm
09-2092 135 mm x 130 mm
09-2093 120 mm x 120 mm
09-2094 105 mm x 100 mm
09-2095 95 mm x 110 mm
09-2096 95 mm x 70 mm



SCREW NUT WRENCH
09-2100
14 x 17 mm

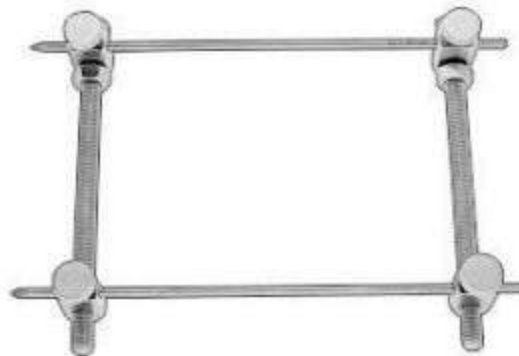

CHARNLEY-MUELLER
09-2110
Compression Clamp



	Inside Length	Inside Width
09-2120	90 mm	75 mm
09-2121	160 mm	90 mm
09-2122	210 mm	110 mm
09-2123	210 mm	150 mm

BONE RONGEURS

Hohlmeißelzangen
Pinzas gubias

Pinces-gouges
Pinze-sgorbie

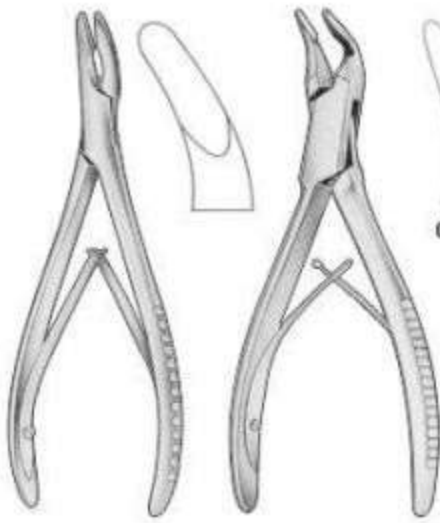

HARTMANN
09-2130
18.5 cm, 7 1/4"

BLUMENTHAL
15 cm, 6"

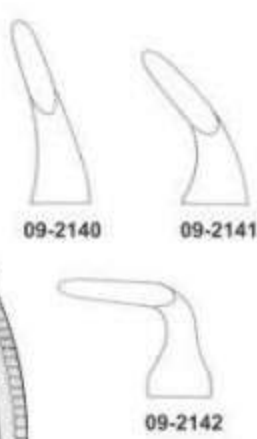

09-2140

09-2141

09-2142



LUER
15 cm, 6"

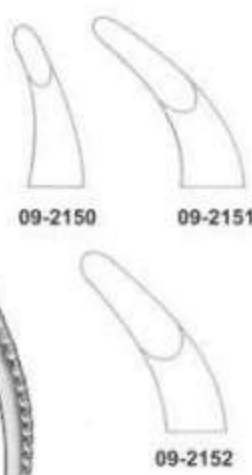

09-2150

09-2151

09-2152



09-2160
12 cm, 4 1/2"
Curved



09-2161
14 cm, 5 1/2"
Curved



09-2170
13.25 cm, 5 1/2"
Angled
17 mm x 3.5 mm

UNIVERSAL

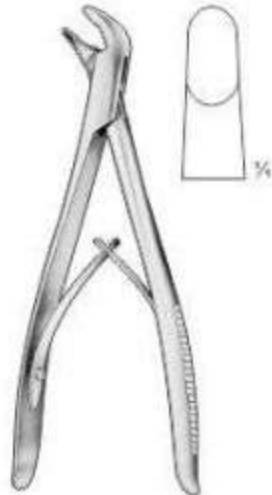

BACON
09-2180
20 cm, 8"



STELLBRINK
SYNOVCTOMY
RONGEUR



09-2190
17.5 cm, 7"

09-2191
17 cm, 6 3/4"

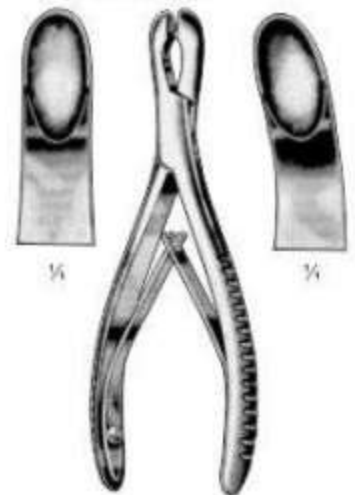

LUER
09-2200 17 cm, 6 3/4" straight
09-2201 17 cm, 6 3/4" curved

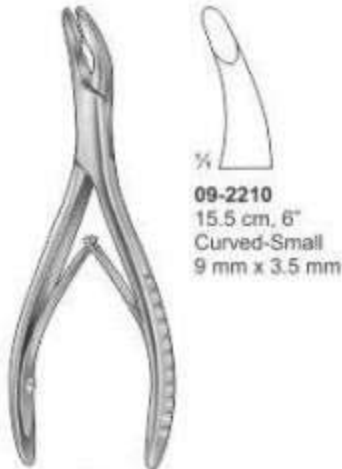

09-2210
15.5 cm, 6"
Curved-Small
9 mm x 3.5 mm

LUER



CLEVELAND
09-2220
14 cm, 5 1/2"

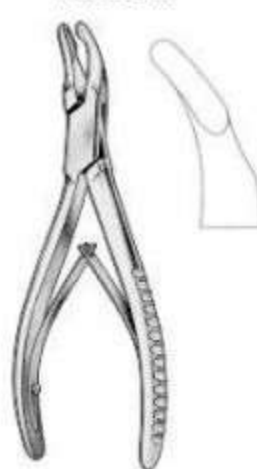

CLEVELAND
09-2230
17 cm, 6 3/4"



MEAD
16.5 cm, 6 1/2"

09-2240

09-2241

BONE RONGEURS

Hohlmeißelzangen
Pinzas gubias

Pinces-gouges
Pinze-sgorbie



LEMPERT
09-2250 19 cm, 7 1/2" straight
09-2251 19 cm, 7 1/2" curved



LEMPERT



ADSON
09-2270
20 cm, 8" Straight
15 mm x 7.5 mm



BANE



HAKANSSON
09-2290
15.5 cm, 6"



STILLE-RUSKIN



LEKSELL-STILLE

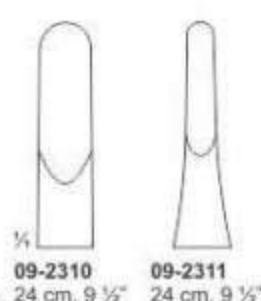

STILLE-LUER

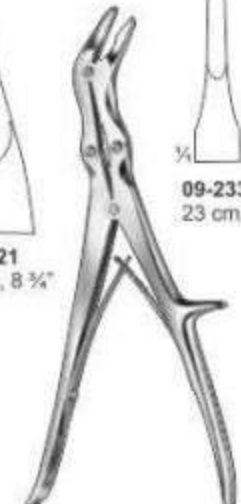
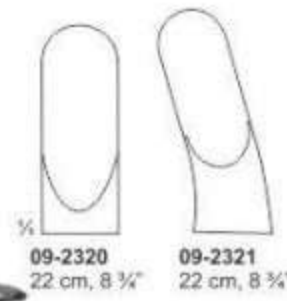

ECHLIN / STILLE-LUER

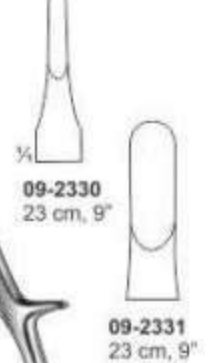

**BEYER
RONGEUR**
09-2340
18 cm, 7" curved

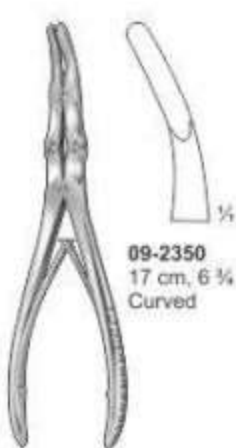

MAYFIELD

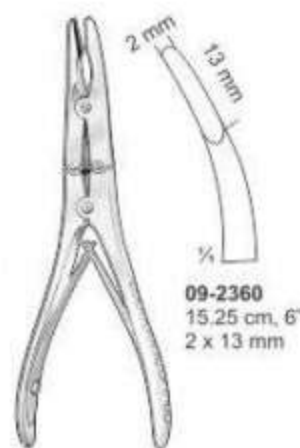

KLEINERT-KUTZ



RUSKIN-MINI



RUSKIN

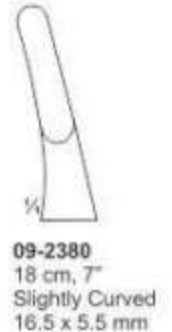

BONE RONGEURS

Hohlmeißelzangen
Pinzas gubias

Pinces-gouges
Pinze-sgorbie

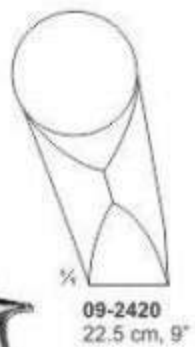
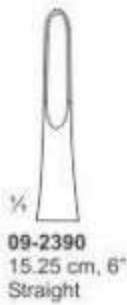

BÖHLER

BEYER

ZAUFAL-JANSEN

SEMB

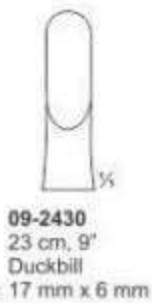

LEKSELL
09-2450 3 mm
09-2451 5 mm
09-2452 8 mm
22 cm, 8 1/4"



MAYFIELD
09-2460
17 cm, 6 3/4"



RUSKIN RONGEUR
09-2470
curved

STILLE

ECHLIN
23 cm, 9"

LEKSELL

MAYFIELD
09-2460
17 cm, 6 3/4"

RUSKIN RONGEUR
09-2470
curved



MARQUARDT
09-2480
20 cm, 8"



STILLE-LUER
Rongeur Forceps



STILLE RONGEUR
FORCEPS
09-2500
23 cm, 9"
Double-Action
jaws 3mm wide
Jaws angled to side



SAUERBRUCH
31 cm, 12 1/4"



BONE CUTTING FORCEPS

Knochensplitterzangen
Pinzas cortantes para hueso

Pinces coupantes à os
Cesoie per ossa

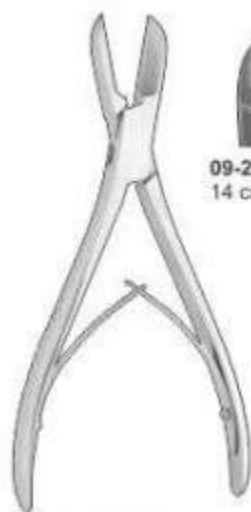

LISTON BONE
Cutting Forceps



09-2520
14 cm, 5 1/2"



09-2521
17 cm, 6 3/4"



09-2522
19 cm, 7 1/2"
09-2523
22 cm, 8 3/4"



LISTON



09-2530
14 cm, 5 1/2"



09-2531
17 cm, 6 3/4"



09-2532
19 cm, 7 1/2"



09-2533
22 cm, 8 3/4"



MARKWALDER



09-2540
20 cm, 8"



LITTAUER / LISTON



09-2550
15 cm, 6"
Straight



CLEVELAND-GARDNER



09-2560
16 cm, 6 1/2"



WALTON-LISTON



09-2570
15 cm, 6"
Straight



09-2571
15 cm, 6"
Angled



RUSKIN-LISTON



09-2580
19 cm, 7 1/2" Straight
09-2581
19 cm, 7 1/2" Curved



STILLE-LISTO



09-2590
27 cm, 10 1/2"
Straight

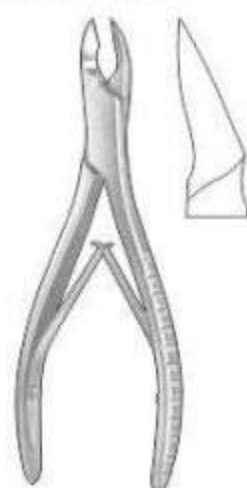

CLEVELAND
09-2600
17 cm, 6 3/4"



CLEVELAND
09-2610
15 cm, 6"



LISTON



09-2620
23 cm, 9"
Angled



09-2621
27 cm, 10 1/2"
Angled

BONE CUTTING FORCEPS

Knochensplitterzangen
Pinzas cortantes para hueso

Pinces coupantes à os
Cesoie per ossa

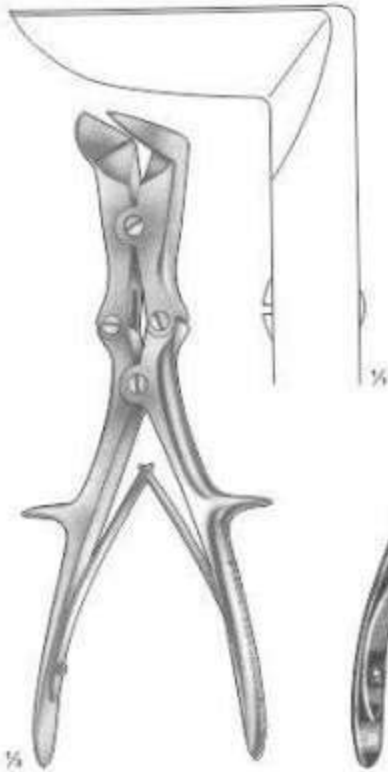

LISTON-STILLE
09-2630
26 cm, 10 1/4"



Mc INDOE
09-2640
17.5 cm, 7"



HORSLEY
Bone Cutting Forceps
09-2650
25 cm, 10"



LISTON-KEY (HORSLEY)
09-2660
26.5 cm, 10 1/2"
Angled, 28 mm



COTTLE-KAZANJIAN
09-2670
19 cm, 7 1/2"

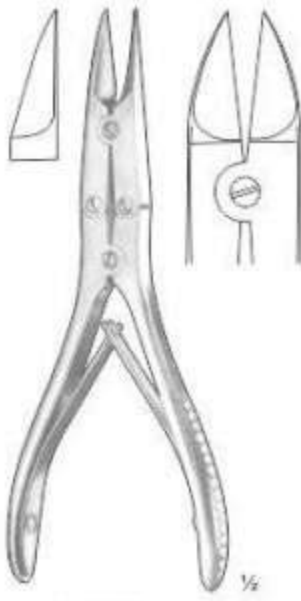

09-2680
15 cm, 5 3/4"

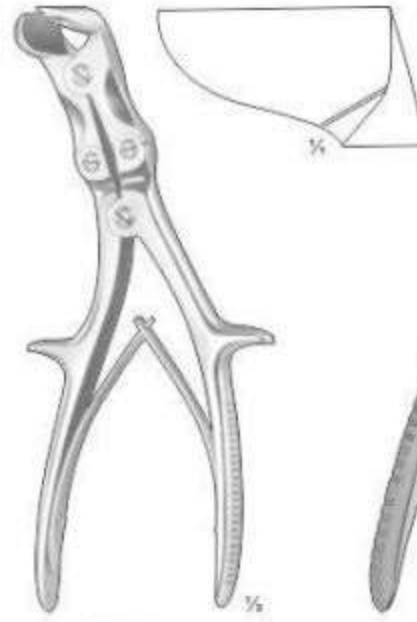

SEMB
09-2690
24 cm, 9 1/2"

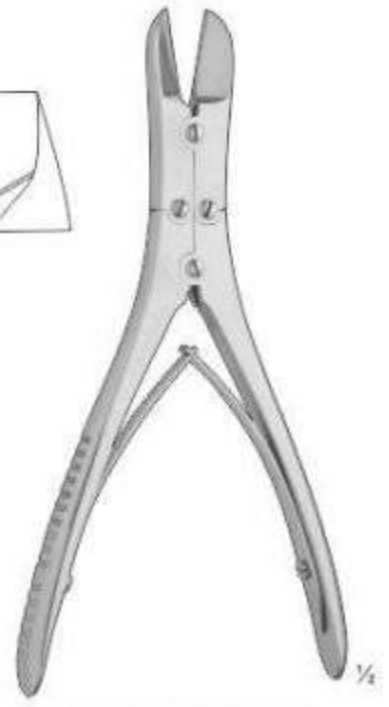

**RUSKIN BONE SPLITTING
FORCEPS**
09-2700
20 cm, 8", Double-Action

FLAT NOSE PLIERS & WIRE CUTTING PLIERS T.C. INSERTED

Pinces plates, Alicates planos, Flachzangen.

Pinces coupantes, Alicates para cortar alambre, Drahtkneifzangen



EXTRACTION PLIERS

09-2710 18 cm, 7"
09-2711 18 cm, 7"



EXTRACTION PLIERS

09-2720
20 cm, 8"



EXTRACTION PLIERS

09-2730
20 cm, 8"



WIRE CUTTERS



WIRE CUTTERS

09-2750
18 cm, 7"



WIRE CUTTERS

09-2760 18 cm, 7"
09-2761 21 cm, 8 ¼"



WIRE CUTTERS

09-2770
18 cm, 7"



UNIVERSAL SCISSORS

09-2780 10 cm, 4"
09-2781 12 cm, 5"



WIRE CUTTER

09-2790
18 cm, 7"



WIRE CUTTERS

09-2800 18 cm, 7"
09-2801 21 cm, 8 ½"



WIRE CUTTERS

09-2810
14 cm, 5 ½"



WIRE CUTTERS

09-2820
22 cm, 8 ¾"



WIRE CUTTERS

09-2830 46 cm, 18"
09-2831 56 cm, 22"

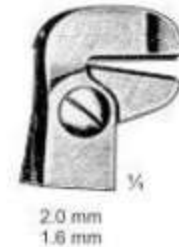

09-2840

24 cm, 9 ½"

DURA HOOKS / NERVE HOOKS

*Duramesser, Durahaken,
Durahaken, Nerv-und Gefäßhäkchen*

*Couteaux Pour Dure-mere, Crochets Pour Dure-mère,
Crochets Pour Dure-mère, Crochets à Nerfs Et à Vaisseaux*

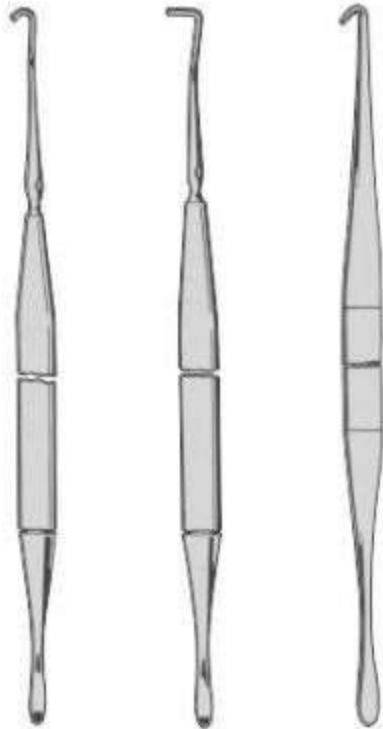

SCOVILLE
10-100

30 cm, 12"
Nerve Hook and
Dissector



SCOVILLE
10-110

30 cm, 12"
Nerve Hook and
Dissector



SCOVILLE
10-120

30 cm, 12"
Sympathectomy Hook
and Dissector



10-130

Davis
4 mm, 19 cm, 7 1/2"



10-140

Sachs
3 mm, 20 cm, 8"



10-150

Sachs
6 mm, 20 cm, 8"



GRAHAM
10-160

16.5cm



SACHS
10-170

16.5cm

NERVE SEPARATOR & SPATULA



FRAZIER
10-180

12.5 cm, 5"



GILLIES
10-190

19 cm, 7 1/2"



10-190
Small

10-191
large



10-200
Straight

13 cm, 5"



LAHEY CLINIC
10-210

13 cm, 5"



SACHS
10-220

18.5 cm, 7 1/4"



10-230

16 cm, 6 1/2"



TOENNIS
10-240

15 cm, 6"



DURA
TWIST HOOK
10-250

14 cm, 5 1/2"

LAMINECTOMY RONGEURS

Laminektomieztangen
Pinzas Para Laminectomia

Pinces Pour Laminectomie
Pinze Per Laminectomia

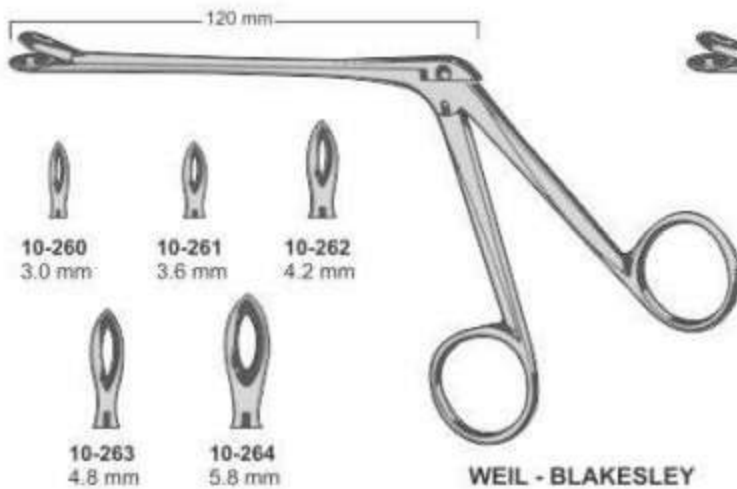

WEIL - BLAKESLEY

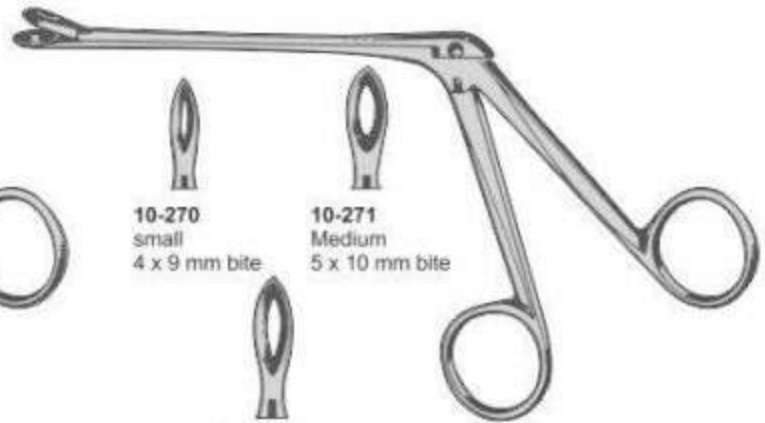

**WILDE INTERVERTEBRAL
DISC RONGEUR**
12.5 cm, 5" shaft
fenestrated jaws straight

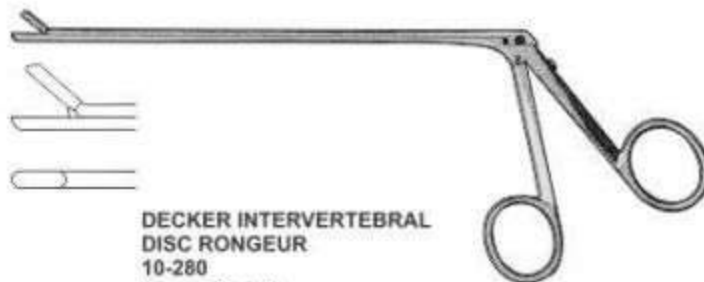

**DECKER INTERVERTEBRAL
DISC RONGEUR**
10-280
15 cm, 6" shaft
2 x 6 mm bite straight



**MICRO GRASPING
FORCEPS**
10-290
serrated, straight



**MICRO ALLIGATOR
SCISSORS**
10-300
straight

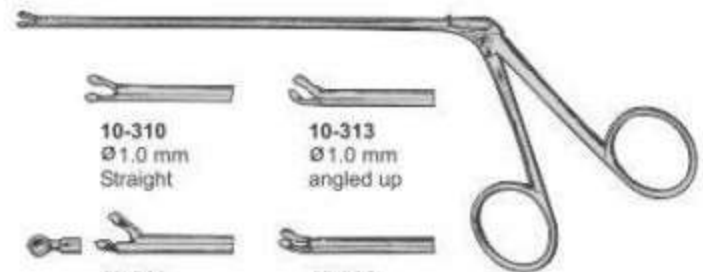

**MIRCO CUP
FORCEPS**

LAMINECTOMY RONGEURS

Laminectomieztangen
Pinzas Para Laminectomia

Pinces Pour Laminectomie
Pinze Per Laminectomia



10-320
Grasping Forceps
Ø 3 mm



10-321
Cup Forceps
Ø 2 mm



10-322
Alligator Scissors
Ø 2 mm

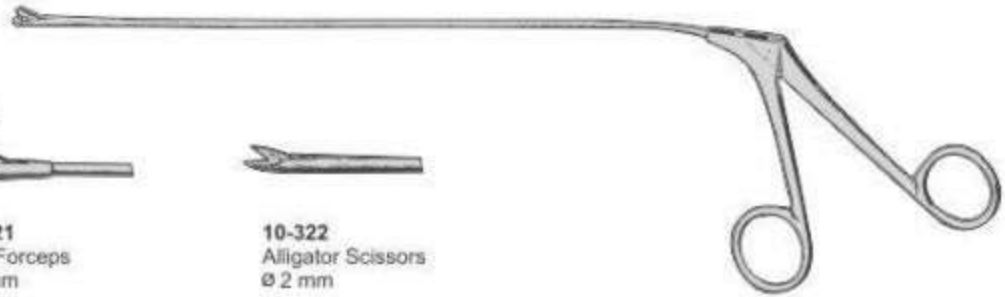

**MICRO ALLIGATOR
FORCEPS**
with tubular shaft
18 cm, 7"

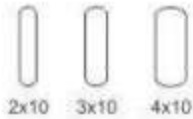

2x10 3x10 4x10



Straight Shaft	180 mm
Bite 2 x 10 mm	10-330
Bite 3 x 10 mm	10-331
Bite 4 x 10 mm	10-332



Angled - up Shaft	180 mm
Bite 2 x 10 mm	10-333
Bite 3 x 10 mm	10-334
Bite 4 x 10 mm	10-335



Angled - down Shaft	180 mm
Bite 2 x 10 mm	10-336
Bite 3 x 10 mm	10-337
Bite 4 x 10 mm	10-338

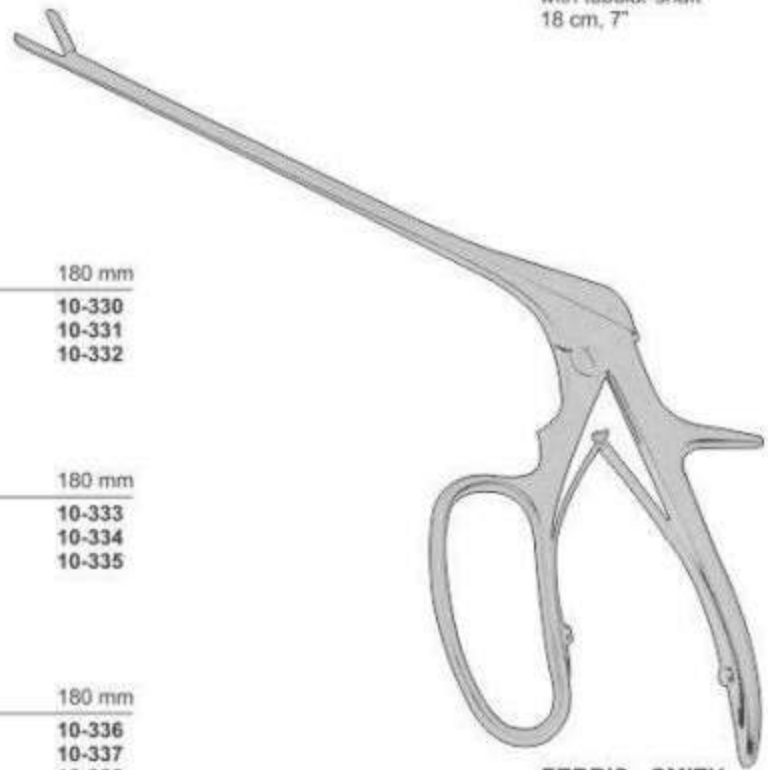

FERRIS - SMITH



4 mm 5 mm 6 mm

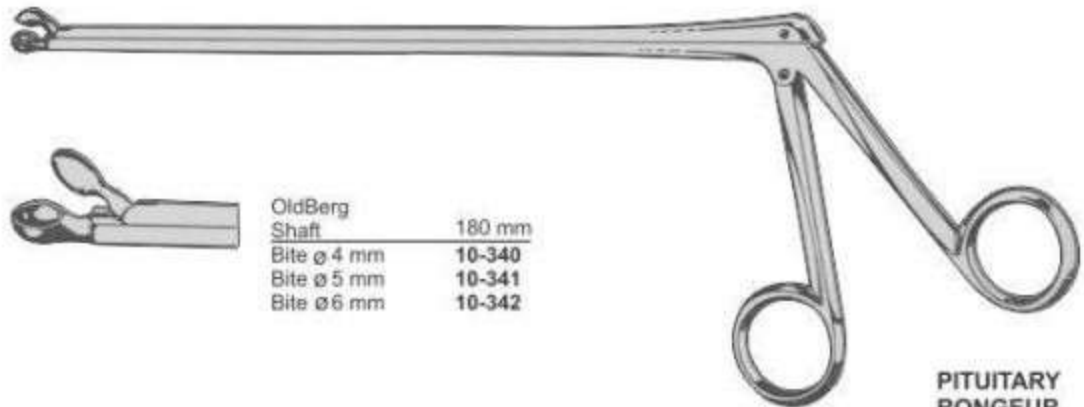

OldBerg Shaft	180 mm
Bite Ø 4 mm	10-340
Bite Ø 5 mm	10-341
Bite Ø 6 mm	10-342

**PITUITARY
RONGEUR**

LAMINECTOMY PUNCHES

Laminektomiestanzen
Pinzas Cortantes Para Laminectomía

Pinces Emporte-pièces à Laminectomie
Pinze Taglienti Per Laminectomia

2.0 mm 3.0 mm 3.5 mm

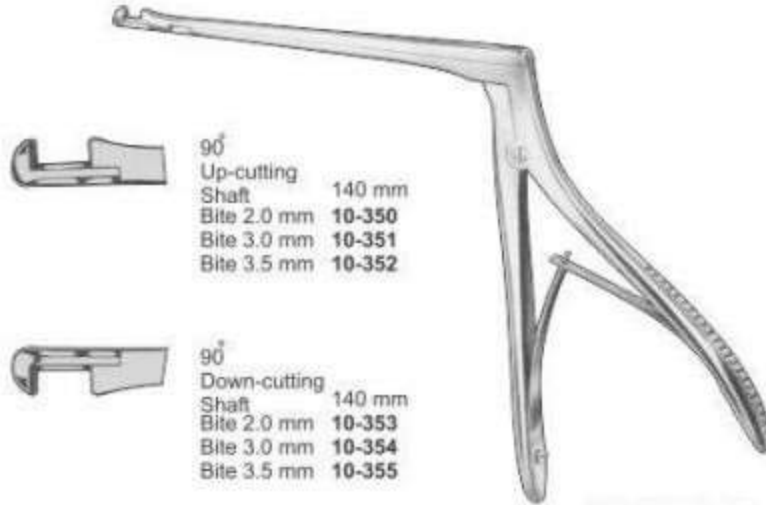

90°
Up-cutting
Shaft 140 mm
Bite 2.0 mm 10-350
Bite 3.0 mm 10-351
Bite 3.5 mm 10-352

90°
Down-cutting
Shaft 140 mm
Bite 2.0 mm 10-353
Bite 3.0 mm 10-354
Bite 3.5 mm 10-355

HAJEK-KOFLER

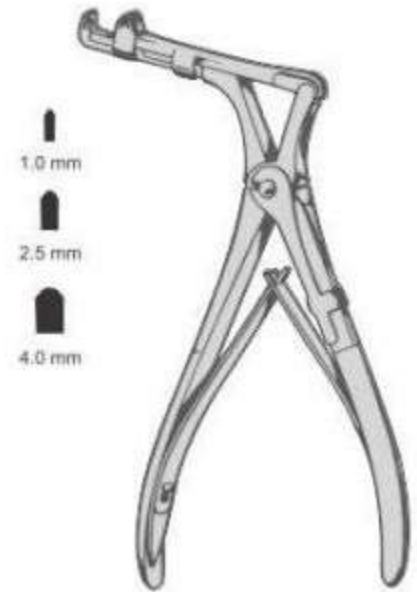

1.0 mm
2.5 mm
4.0 mm

CITELLI
10-360 1.0 mm
10-361 2.5 mm
10-362 4.0 mm

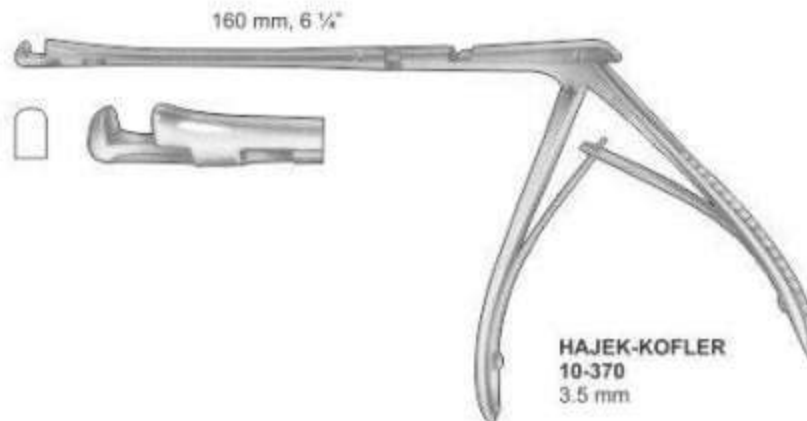

160 mm, 6 1/4"

HAJEK-KOFLER
10-370
3.5 mm

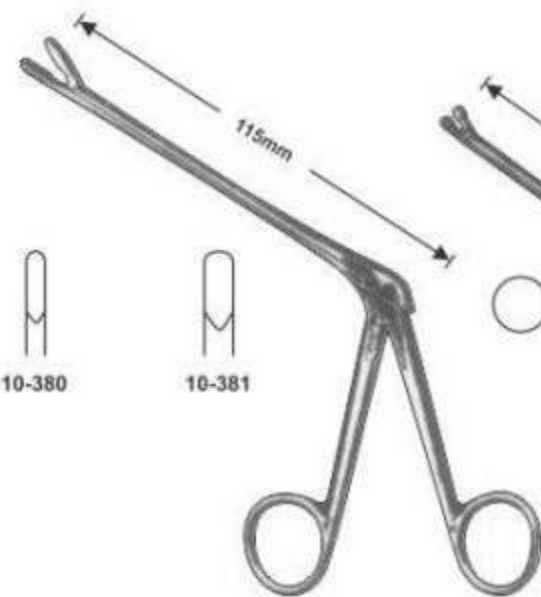

10-380
10-381

SPURLING-LOVE
10-380 28cm
10-381 28cm

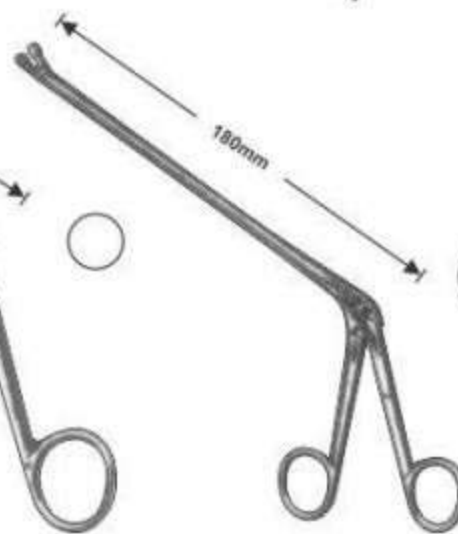

OLDBERG
10-390 25cm



COLCLOUGH
10-400 27cm UP CUTTING
10-401 27cm DOWN CUTTING

PUNCHES

Laminektomiestanzen
Pinzas Cortantes Para Laminectomia

Pinces Emporte-pièces à Laminectomie
Pinze Taglienti Per Laminectomia



LOVE-KERRISON
LAMINECTOMY PUNCH



Forward 90° Regular Footplate

	2 mm bite forward	
	10-410	150 mm
	10-411	200 mm

	3 mm bite forward	
	10-412	150 mm
	10-413	200 mm

	4 mm bite forward	
	10-414	150 mm
	10-415	200 mm

	5 mm bite forward	
	10-416	150 mm
	10-417	200 mm

	6 mm bite forward	
	10-418	150 mm
	10-419	200 mm



Up 40° Regular footplate

	2 mm bite up	
	10-420	150 mm
	10-421	200 mm

	3 mm bite up	
	10-422	150 mm
	10-423	200 mm

	4 mm bite up	
	10-424	150 mm
	10-425	200 mm

	5 mm bite up	
	10-426	150 mm
	10-427	200 mm

	6 mm bite up	
	10-428	200 mm



Down 90° Regular footplate

	3 mm bite down	
	10-429	150 mm
	10-430	200 mm

	4 mm bite down	
	10-431	150 mm
	10-432	200 mm

	5 mm bite down	
	10-433	150 mm
	10-434	200 mm

LAMINA SPREADERS FORCEPS

Wirbelkörperspreizer
Separadores Para Cuerpos Vertebrales

Ecarteurs Pour Corps Vertébraux
Separatori Per Vertebre

BRAIN CLAMPS



MCKENZIE
10-440 15cm
10-441 19cm



RANEY
10-450
16 cm, 6 1/2"



ADSON
10-470 15 cm, 6"
Drill Guide and
Dura Protector

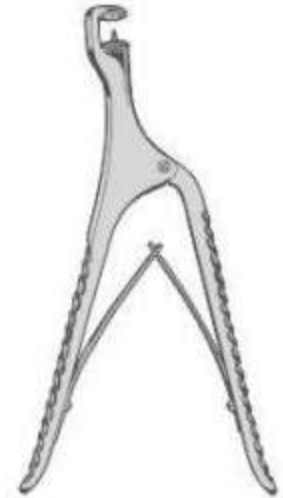

CONE
10-480 20 cm 8"
10-481 23 cm 9"
Skull Punch



DAHLGREN
10-490 20 cm, 8"
Complete with 2 Blades



DE VILBISS
10-500
Skull cutting forceps
21cm, 8 1/4"



INGE
10-510
16 cm, 6 1/2"
Small pattern

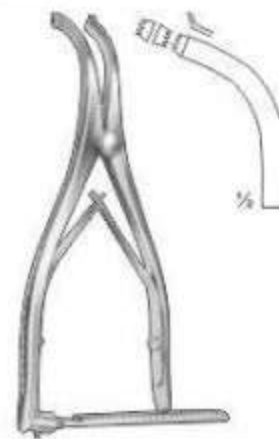

INGE
10-520
17 cm, 6 1/2"



INGE 26 cm, 10 1/4"
10-530 Jaw width 5 mm
10-531 Jaw width 10 mm
large pattern



CLOWARD
10-540
13 cm, 5"



LUMBAR LAMINA SPREADER
10-550
arm length: 87.5 mm
spread: 37.5 mm



CLOWARD
10-560
16 cm, 6 1/2"



10-570
14 cm, 5 1/2"

OPHTHALMOLOGY



BOWMAN
11-100 7 cm

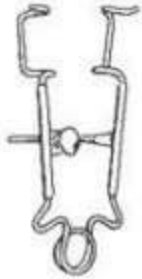

CRITCHETT
11-110 6 cm



SMITH
11-120 5 cm



CLARKE
11-130 8 cm



GRAEFE
11-140 6 cm
11-141 9 cm

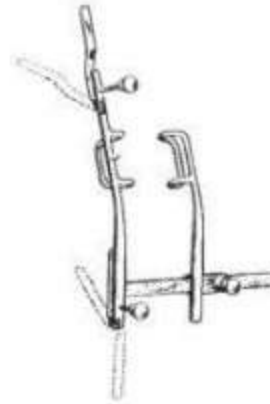

ARRUGA
11-150 7 cm L
11-151 9 cm R



MELLINGER
11-160 7 cm



MUELLER
11-170 7 cm



DESMARRES
11-180 12 cm
11-181 14 cm
11-182 16 cm
11-183 18 cm

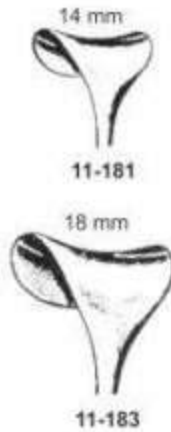

CATARACT
11-190 Fig 1
11-191 Fig 2
11-192 Fig 3
11-193 Fig 4
11-194 Fig 5
11-195 Fig 6

KNIVES

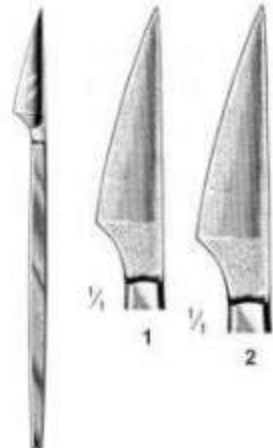
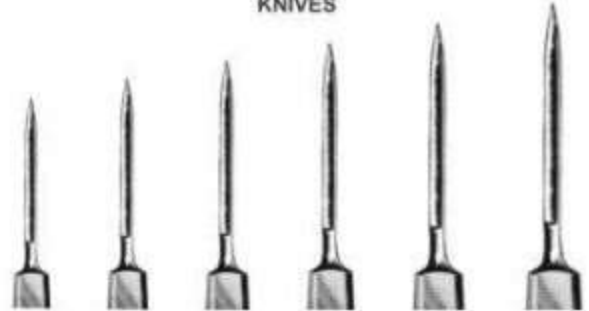

BEER
11-200 Fig 1
11-201 Fig 2

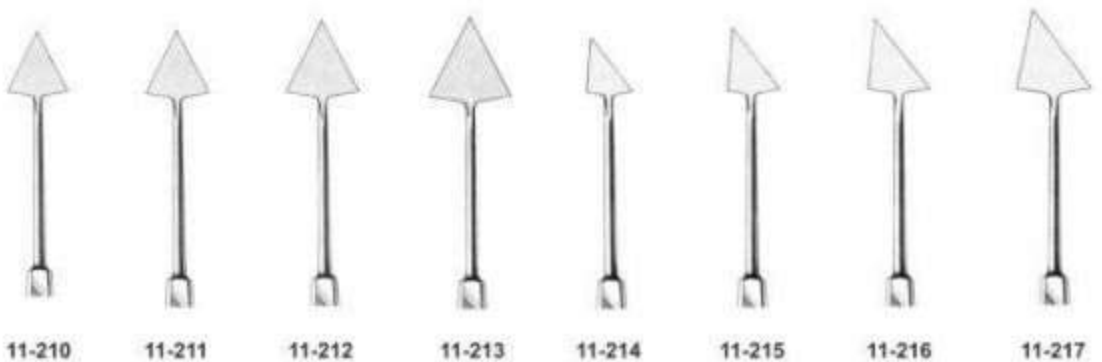

JAEGER

JAEGER

OPHTHALMOLOGY



SNELLEN
11-220 R
11-221 L



DESMARRES
11-230 10cm 11-231



KNAPP
11-240 11cm

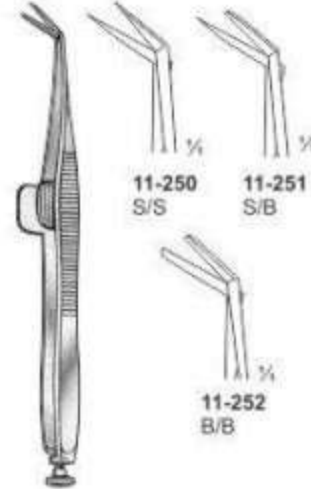

WECKER
11-250 11cm
11-251 11cm
11-252 11cm



AYER
11-260 9cm



LAMBERT
11-270 9cm



DESMARRES
11-280 9cm
11-281 9cm
11-282 9cm



11-280

11-281

11-282



1:2 DASTOOR
11-290 10cm

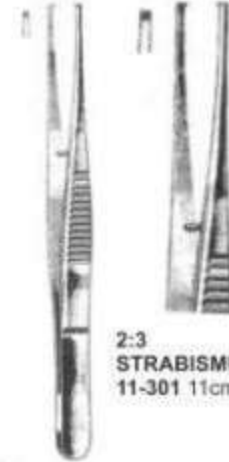

1:2 STRABISMUS
11-300 11cm

2:3 STRABISMUS
11-301 11cm



CASTROVIJO
11-310 9cm



WORTH
11-320 10cm



WORTH
11-330 10cm



1:2 HESS
11-340 9cm

HESS
9cm



1:2 FISCHER
11-350



1:2 FISCHER
11-360 7cm



1:2 FISCHER
11-370

OPHTHALMOLOGY



ARRUGA
11-380 9.5cm



ELSCHING
11-390 10cm



HESS
11-400 6.5cm



11-410 6cm



FUCHS
11-420 7cm



HESS
11-430 6cm



ELSCHING
11-440 11cm



GRAEFE
11-450 11cm



GRAEFE
11-460 11cm



SCHMIDT-RIMPLEX
11-470 11cm



GRAEFE Serrated
11-480 10cm 11-483
11-481 10cm 11-484
11-482 10cm 11-485



11-480



11-481



11-482



11-483



11-484



11-485



STR
11-490



GRAEFE
7cm



CUR
11-500



1:2 STR
11-510



GRAEFE
7cm



1:2 STR
11-520



BISHOP-HRRMAN SERRATED
1:2 11-530 8.5cm 11-531



1:2 HESS
11-540



HESS
1:2 11-550

EAR SPECULA

Ohrspekula
Especulos Auriculares

Spéculms Auriculares
Specoli Auricolari

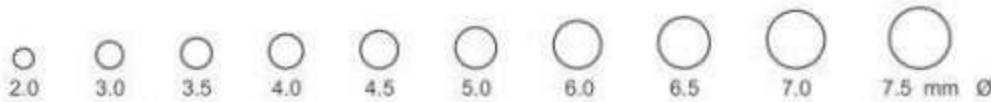

BOUCHERON
12-100 Set of 4
12-101 3.5 mm
12-102 4.5 mm
12-103 5.5 mm
12-104 6.5 mm



PLOITZER
12-110 Set of 4
12-111 2 mm
12-112 3 mm
12-113 4 mm
12-114 5 mm



HARTMANN
for children
12-120 Set of 3
12-121 2 mm
12-122 3.5 mm
12-123 5 mm



HARTMANN
Set of 4, For Adults
12-130 4.0 mm
12-131 5.0 mm
12-132 6.0 mm
12-133 7.5 mm



ZOLLNER
Set of 6, Alu Black

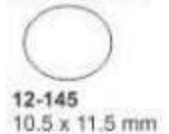

GRUBER AURAL SPECULA
Black finish, diam, 38 mm
12-150 Set of 4
12-151 3 mm
12-152 4 mm
12-153 5 mm
12-154 7 mm



ROSEN
Black finish, slotted round ends 35 mm
12-160 Set of 4
12-161 3 mm
12-162 4 mm
12-163 5 mm
12-164 7 mm



ROSEN
slotted round ends
Black finish, 35 mm
12-170 Set of 4
12-171 4 mm
12-172 5 mm
12-173 6 mm
12-174 7 mm



TUMARKIN
Tapered Slot
12-180 Size Set of 8
12-181 0 4.5 mm
12-182 1 6.5 mm
12-183 2 7.0 mm
12-184 3 7.5 mm
12-185 4 8.0 mm
12-186 5 8.5 mm
12-187 6 9.0 mm
12-188 7 11. mm



SIEGLE
Single Part:
12-200 to 12-201 Diagnostic Head Complete Set
Aural magnifier, anastigmatic, complete with:
12-202 1 diagnostic head
12-203 to 12-205 3 ear specula
12-206 1 rubber bulb with rubber tube and connection cone



NASAL TOMPON, CURETTES, TYMPANUM NEEDLE

Nasentamponinzetten, Currettes, Trommelfellnadeln
Septumzangen, siebbeinküretten, Aguja Para Timpano

Pincesa à Pansements, Curette, Aiguilles Pour Le Tympan
Pincas Pour La Cloison Nasal, Curetas, Aghi Per Timpano



REINER
12-210
Tip Only

REINER
12-211
Tip Only

12-212
Shield

12-213 50CC Complete
75CC Complete
12-214 100CC Complete
150CC Complete
With Tip & Shield

- 12-220 Ø 2 mm
- 12-221 Ø 2.5 mm
- 12-222 Ø 3 mm
- 12-223 Ø 4 mm
- 12-224 Ø 5 mm

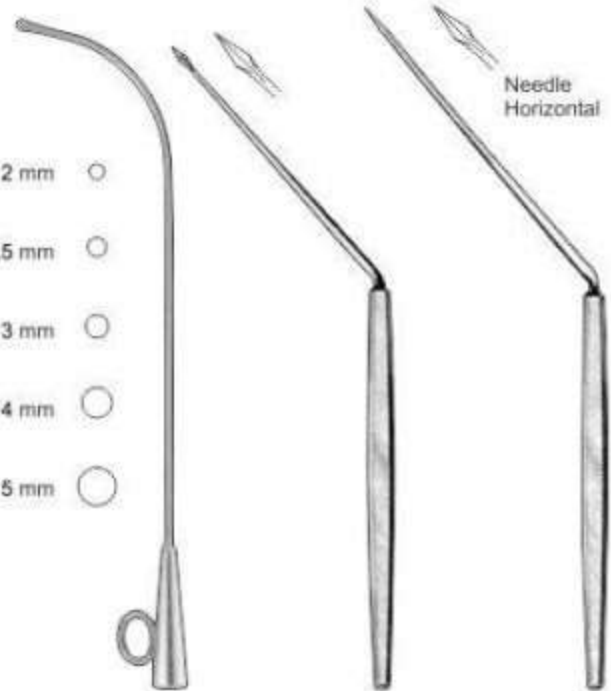

Hartmann
Eustachian
Catheters

POLITZER
12-230
16.5 cm, 6 1/2"

POLITZER
12-240
16.5 cm, 6 1/2"

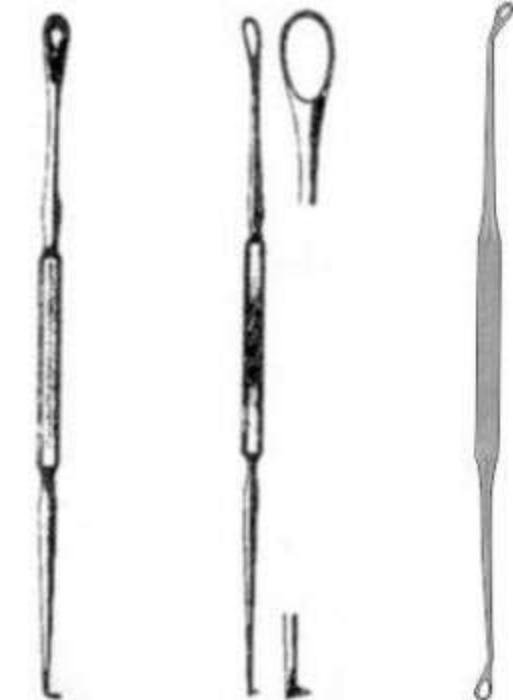

GROSS
12-250

GROSS
12-260

COAKLEY SINUS
CURETTES

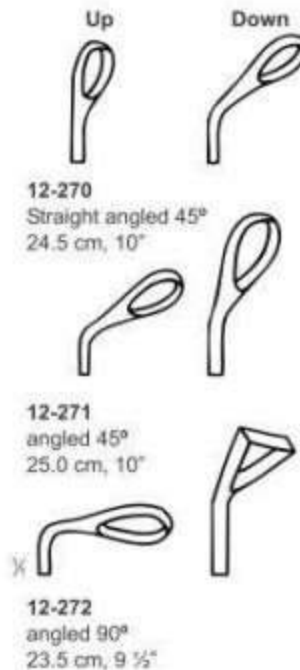

12-270
Straight angled 45°
24.5 cm, 10"

12-271
angled 45°
25.0 cm, 10"

12-272
angled 90°
23.5 cm, 9 1/2"



KRAUSE-VOSS
12-280
25 cm, 10"
Nasal Polypus Snare,
knee shaped, complete

WILDE
12-290
Nasal Polypus Snare,
bayonet-shaped

EAR POLYPUS FORCEPS, SEPTUM FORCEPS

Ohrpolypenzangen, Nasenpolypenzangen
Pinzas Para Pólipos Auriculares, Pinzas Para Pólipos Nasaes

Pinces Pour Polypes Auriculaires, Pinces À Polypes Nasaux
Pinze Per Polipi Auricolari, Pinze Per Polipi Nasali



TROELTSCH
12-300
11 cm, 4 1/2"



LUCAE
12-310
14 cm, 5 1/2"



QUIRE
12-320
12 cm, 4 3/4"



HARTMANN
12-330
16 cm, 6 1/4"
12-331
20 cm, 8"



HEYMANN-KNIGHT
12-340
18 cm, 7"



LUBET-BARBON
12-350
20 cm, 8"

ALLIGATOR EAR FORCEPS

Alligator-ohrfaßzangen
Pinces crocodiles à oreilles

Pinze alligatore per orecchi
Pinzas de boca de cocodrilo para el oído



HARTMANN-WULLSTEIN
12-360



HARTMANN-WULLSTEIN
12-361



HARTMANN
12-362
12-363



HARTMANN
12-364
12-365



HARTMANN-NOYES
12-366



DUCKBILL
12-367



WEINGÄRTNER
12-368



HARTMANN
12-369 = 2.0 mm
12-370 = 2.5 mm
12-371 = 3.0 mm



HARTMANN
12-372 = 2.0 mm
12-373 = 2.5 mm
12-374 = 3.0 mm



STRÜMPEL
12-375



HARTMAN
12-376



HARTMANN
12-377



HARTMANN-HOFFMANN
12-378

NASAL SPECULUM

Nasenspekula
Especulos Nasaes

Spéculums Nasaux
Specoli Nasali



VIENNA NASAL SPECULUM
12-390 - Infant
12-391 - Child
12-392 - Adult
14 cm, 5 1/2"



KILLIAN NASAL SPECULUM
12-400 35 mm 2" Small blade
12-401 50 mm 3" Medium blade
12-402 75 mm
12-403 90 mm
13 cm, 5 1/2"

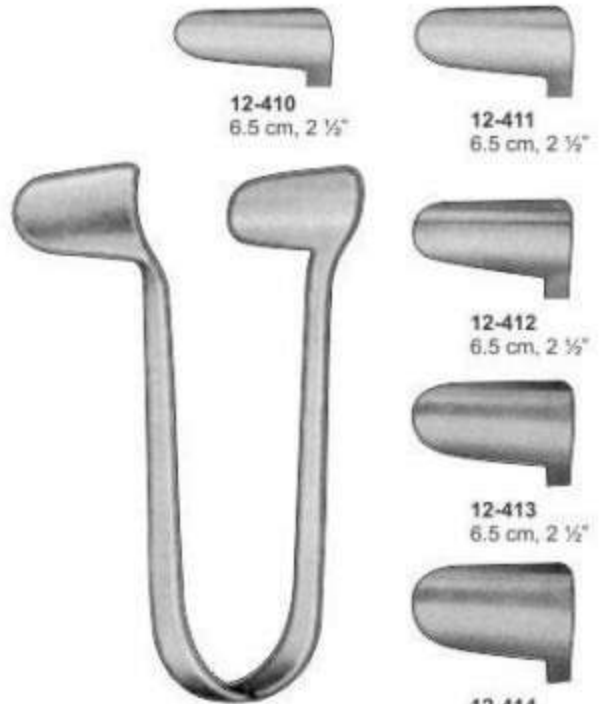

THUDICHUM (Golfsmith)

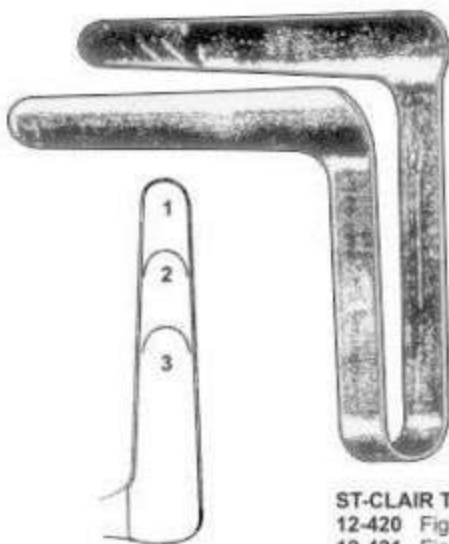

ST-CLAIR THOMSON
12-420 Fig 1
12-421 Fig 2
12-422 Fig 3

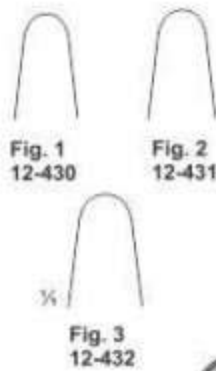

VOLTOLINI (Duplay)



YANKAUER
12-440
19cm

SEPTUM FORCEPS, TONSIL PUNCHES

Nasenpolypenzangen, Tonsillenzangen
Pinzas Para Pólipos Nasaes, Pinzas Para Amígdalas

Pinces À Polypes Nasaux, Pinces Pour Amygdales
Pinze Per Polipi Nasali, Pinze Per Tonsille

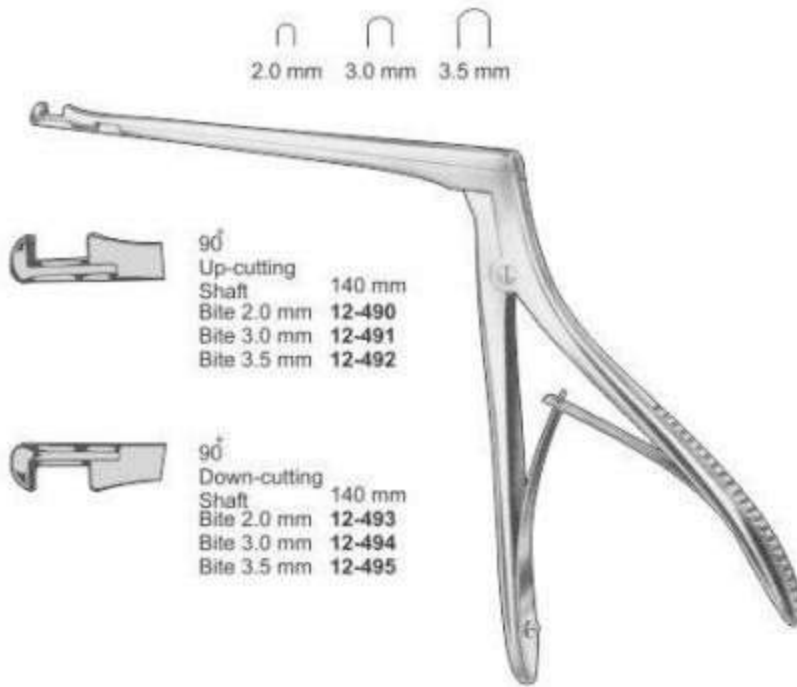

HAJEK-KOFLER

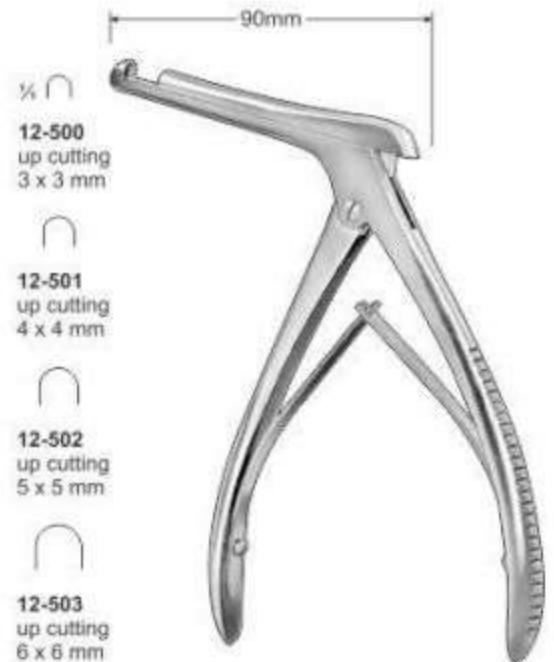

KERRISON
41-148
9 cm, 3 1/2"

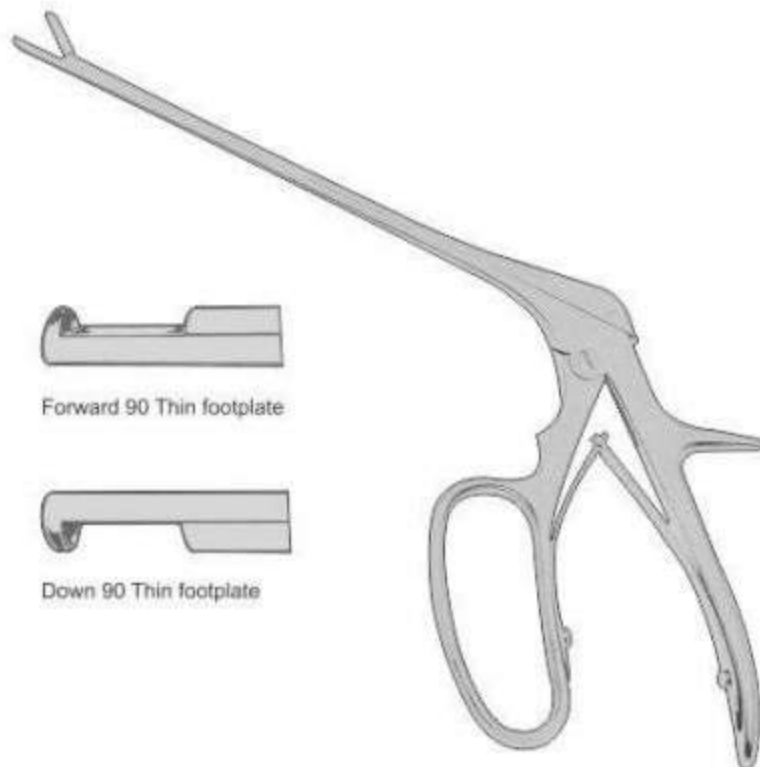

FERRIS - SMITH
12-510

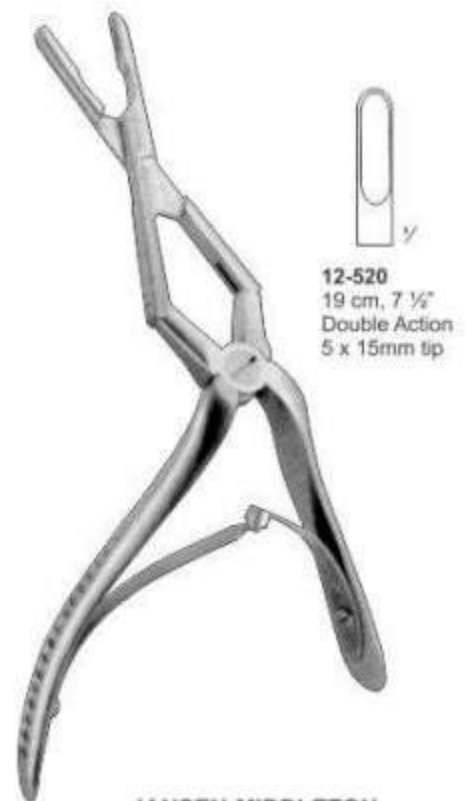

JANSEN-MIDDLETON

SEPTUM FORCEPS, SEPTUM KNIVES, CURETTES

Septumzangen, Septummesser, Ohrküretten
Septumrichtzangen, Cuchillos Para Tabique Nasal, Curettes

Pinces Pour La Cloison Nasale, Bistouris Pour La Cloison Nasale, Curettes
Pinze Per il Setto Nasale, Bisturi Per Il Setto Nasale, Cuette



ASCH
12-530
23 cm, 9"



1/4
12-540
right



WALSHAM
21 cm, 8 1/4"



12-541
left



BRUNINGS
12-550
15.5 cm, 6 1/4"
Septatome



FREER
12-560
15 cm, 6"



FREER
12-570
15.5 cm, 6 1/4"
Mucous Knife



FREER
12-580
19 cm, 7 1/2"
Respiratory sharp
4 mm



FREER
12-590
19 cm, 7 1/2"
Respiratory sharp
4 mm



BUCK
16.5 cm, 6 1/2"



Curved



Blunt



Sharp



12-600
Blunt
12-601
Sharp



12-602
Blunt
12-603
Sharp



12-604
Blunt
12-605
Sharp



12-606
Blunt
12-607
Sharp



1/4
12-608
Blunt
12-609
Sharp



12-610
Blunt
12-611
Sharp



12-612
Blunt
12-613
Sharp



12-614
Blunt
12-615
Sharp



BALLENGER
12-620 4 x 3 mm
12-621 5 x 4 mm
12-622 6 x 5 mm
20 cm, 8"
Swivel Knife,
bayonet-shaped



3 mm



4 mm



5 mm
1/4

SEPTUM CHISELS, SEPTUM GOUGES

Septummeißel, Septum-Hohlmeißel

Cinceles Para Tabique Nasal, Gubias Para Tabique Nasal

Ciseaux-burins Pour La Cloison Nasale, Gouges Pour La Cloison Nasale

Scalpello Per il Setto Nasale, Sgorbie Per il Setto Nasale



FREER
12-630
16 cm, 6 1/4"
4 mm wide
Septum Chisel,
straight



FREER
12-640
16 cm, 6 1/4"
4 mm wide
Septum Chisel,
curved



FREER
12-650
15 cm, 6"
6 mm wide
Septum Gouge,
straight



BALLENGER
12-660
15.5 cm, 6"
6 mm wide
Septum Gouge



KILLIAN
12-670
17 cm, 6 3/4"
5 mm wide
Septum Gouge



FREER
12-680
19cm 7 1/2"
blunt



FREER
12-690
18cm 7"
sharp



EICKEN-KILLIAN
12-700
3mmØ



KILLIAN
12-710
1.5cmØ



HARTMANN
12-720
1.5cmØ



HARTMANN
12-730 2mmØ
12-731 2.5mmØ
12-732 3mmØ

ADENOID CURETTES

Ringmesser
Cuchillos Para Adenoide

Couteaux à Végétations Adénoïdales
Coltelli Per Vegetazioni Adenoidee



Beckmann
22 cm, 8 3/4"



12-740



12-741



12-742



12-743



12-744



12-745



ST. CLAIR-THOMSON
21cm, 8 1/4"



12-750



12-751



12-752



12-753



LA FORCEPS
Adenotomes
23 cm, 9"



12-760



12-761



12-762



12-770

JOSEPH

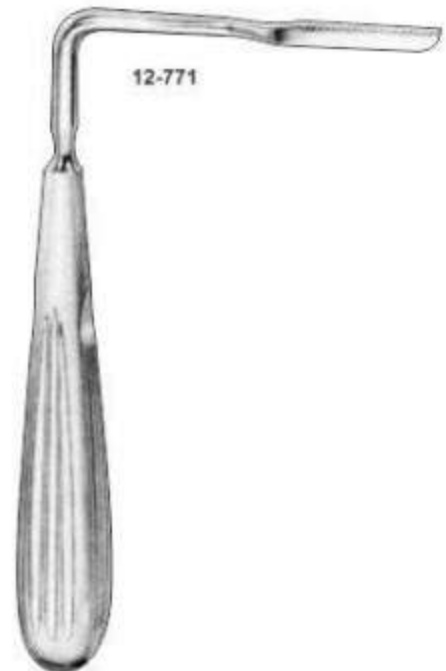

12-771

MOUTH GAG, LIP & CHEEK RETRACTORS

Mundsperrer, Lippen- u. Wangenhalter
Abrebocas, Separadores Para Labios y Mejillas

Ouvre-bouche, Ecarteurs Des Lèvres et Joues
Apribocca, Separatori Per Labbra e Guancia



MOLT
12-780
11 cm, 4 1/2"



DOYEN-COLLIN
12-790 12 cm, 5"
12-791 14 cm, 5 1/2"
Mout Gag



FERGUSON-ACKLAND
12-800
14.5 cm, 5 3/4"



DENHARDT
12-810
12.5 cm, 5"
Mouth Gag
with silicon inserts,
interchangeable



ROSER-KONIG
12-820
16 cm, 6 1/4"
Mouth Gag



HEISTER
12-830 13 cm, 5"
Mouth Gag

MOUTH GAG, LIP & CHEEK RETRACTORS

Mundsperrer, Lippen- u Wangenhalter
Abrebocas, Separadores Para Labios y Mejillas

Ouvre-bouche, Ecarteurs Des Lèvres et Joues
Apribocca, Separatori Per Labbra e Guancia



DAVIS-BOYLE
12-840
Complete Set
Double Bite-Lift Side
Gag only left side



DAVIS-BOYLE
12-850 20 X 25mm
12-851 22 X 60mm
12-852 25 X 75mm
12-853 25 X 90mm
12-854 27 X 105mm
Tongue Blades only.

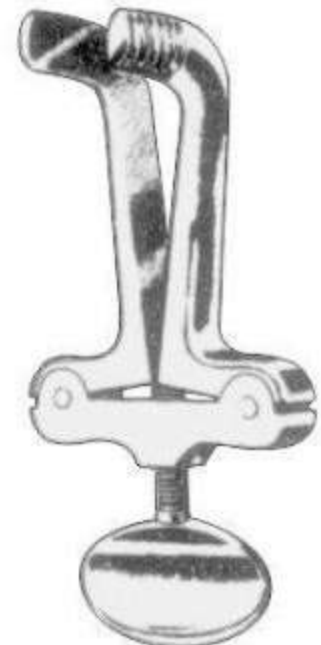

HEISTER
12-860 12 cm, 4.75"
Mouth Gag



WHITEHEAD-JENNINGS
12-870 9 cm, 3 1/2"
12-871 11 cm, 4 1/4"
12-872 13 cm, 5"
12-873 15 cm, 6"
Mouth Gag

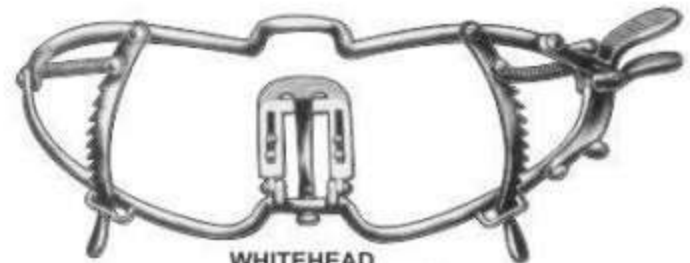

WHITEHEAD
12-880 11 cm, 4 1/4"
12-881 13 cm, 5"
12-882 15 cm, 6"
Mouth Gag
with tongue depressor

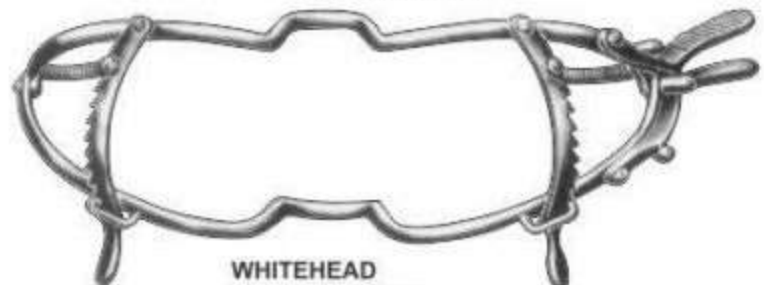

WHITEHEAD
12-890 9 cm, 3 1/2"
12-891 11 cm, 4 1/4"
12-892 13 cm, 5"
12-893 15 cm, 6"
Mouth Gag

TONGUE DEPRESSORS

Lippen- u Wangenhalter
Separadores Para Labios y Mejillas

Ecarteurs Des Lèvres et Joues
Separatori Per Labbra e Guancia



BUCHWALD
12-900
Tongue Depressor
18 cm, 7"



BRUENINGS
12-910
Tongue Depressor
19 cm, 7 1/2"



TONGUE DEPRESSOR
12-920
14.5 cm, 5 1/2"



TONGUE DEPRESSOR
12-930
14.5 cm, 5 1/2"



12-940
14.5 cm, 5 1/2"
serrated 28 mm

12-941
14.5 cm, 5 1/2"
serrated 32 mm

WEIDER



TOBOLD
12-950
14.5 cm, 5 1/2"



TONGUE DEPRESSORS
12-960

TONGUE DEPRESSORS

Lippen- u Wangenhalter
Separadores Para Labios y Mejillas

Ecarteurs Des Lèvres et Joues
Separatori Per Labbra e Guancia



CARMALT
12-970
12.5 cm, 5"

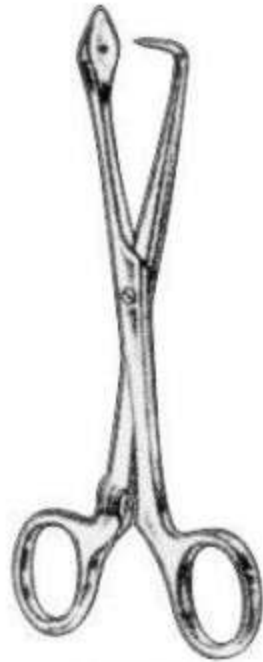

CARBOULD
12-980
14 cm, 5 1/2"

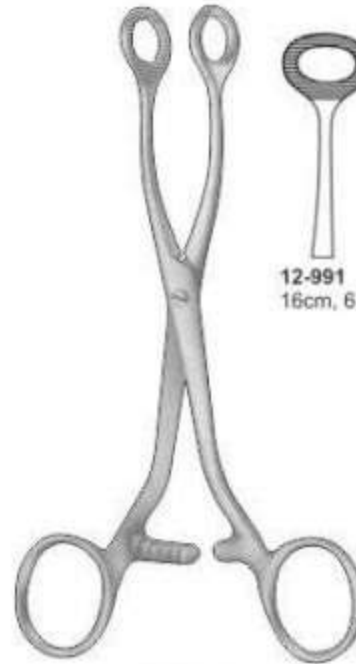

COLLIN
12-990



12-991
16cm, 6 1/4"



12-992
16cm, 6 1/4"



12-993
17cm, 6 3/4"



GUY
12-1000
16 cm, 6"

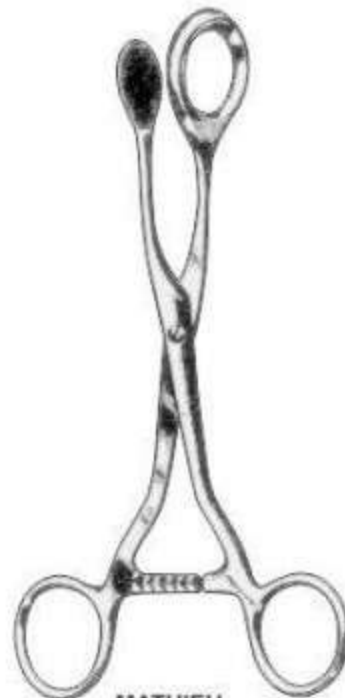

MATHIEU
12-1010
19 cm, 7 1/2"



YOUNG
12-1020
16 cm, 6 1/4"



12-1021
pair

X

TONSIL GRASPING FORCEPS, TONSIL FORCEPS

Tonsillenfasszangen, Tonsillenklemmen
Pinzas Para Amigdalas

Pinces Pour Amygdalas
Pinze Per Tonsille



TONSIL GRASPING FORCEPS, TONSIL FORCEPS

Tonsillenfasszangen, Tonsillenklemmen
Pinzas Para Amigdalas

Pinces Pour Amygdalas
Pinze Per Tonsille

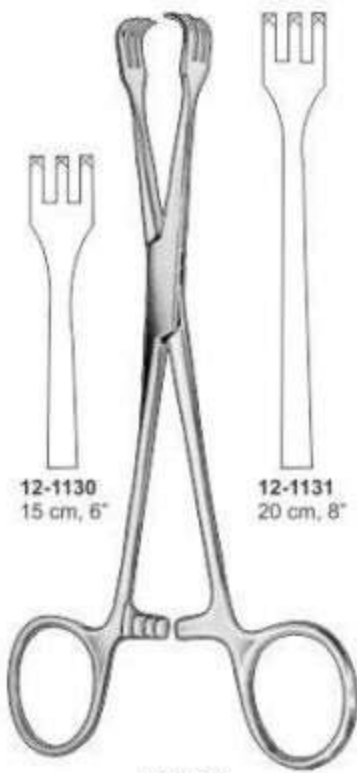

12-1130
15 cm, 6"

12-1131
20 cm, 8"

LAHEY



Mastin
12-1140
17cm 6 3/4"



Schoemaker
12-1150
15cm 6"



Kocher
12-1160
15cm 6"

Kocher
12-1170

12-1161
16cm 6 1/4"



Unna
12-1180
14cm 5 1/2"

Unna
12-1190
14cm 5 1/2"



12-1200
18 cm, 7"
Sharp

12-1201
18 cm, 7"
sharp

GILLIES



12-1210
15 cm, 6"
blunt

KILNER

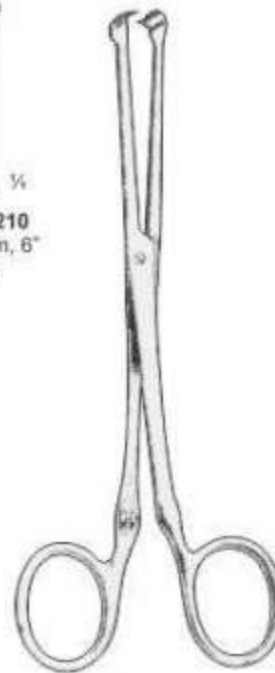

Allis
12-1220 15cm
4:5



Allis
12-1230 15cm 6"
12-1231 19cm 7 1/2"
12-1232 25cm 10"

INTESTINAL & TISSUE GRASPING FORCEPS

Darm-und Gewebefasszangen
Pinzas Para Intestinos y Tejidos

Pinces Pour Saisir Intestins et Tissus
Pinze Per Afferrare Intestino e Tessuti



ALLIS
13-100
20.0 cm, 8"

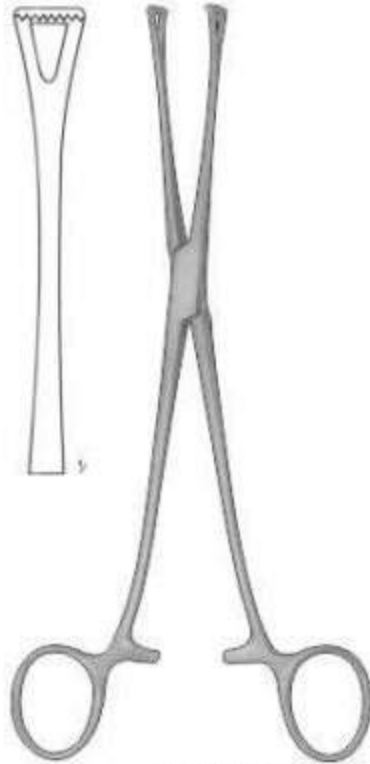

LOCKWOOD
13-110
20.0 cm, 8"



ALLIS ADAIR
13-120 15.5 cm



LOCKWOOD
13-130
20cm 8"

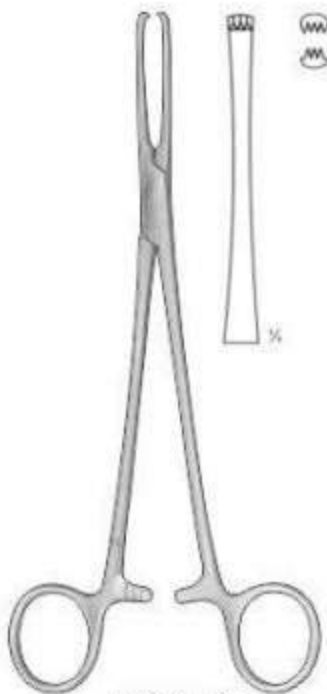

JUDD-ALLIS
13-140
3 x 4 teeth
19.5 cm, 7 7/8"



LITTLEWOOD
13-150
19 cm, 7 1/2"



STILLE
13-160
20 cm, 8"



LANE
13-170 12.5 cm
13-171 15.0 cm
13-172 19.0 cm

INTESTINAL & TISSUE GRASPING FORCEPS

Darm-und Gewebefasszangen
Pinzas Para Intestinos y Tejidos

Pinces Pour Saisir Intestins et Tissus
Pinze Per Afferrare Intestino e Tessuti



LANE

13-180 12.7 cm, 5"
13-181 15 cm, 6"
13-182 19 cm, 7 1/2"

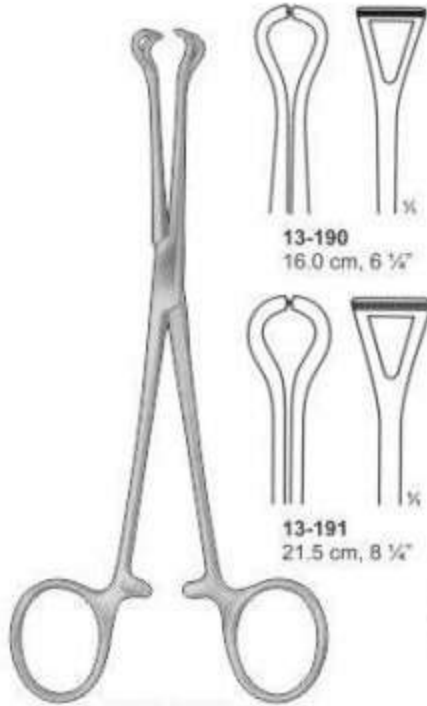

BABCOCK

13-190
16.0 cm, 6 1/4"

13-191
21.5 cm, 8 1/4"

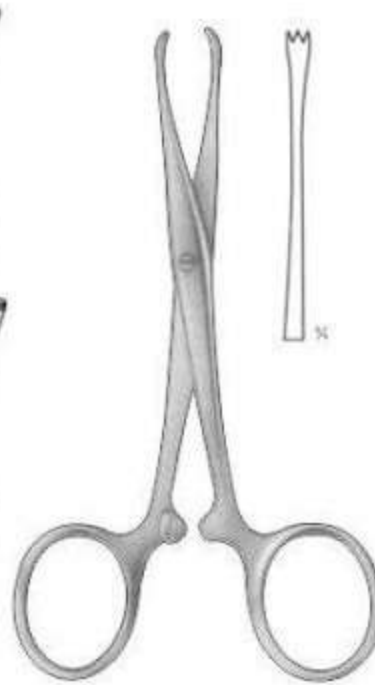

CHAPUT

13-200
2 x 3 teeth, sharp
12.5 cm, 5"

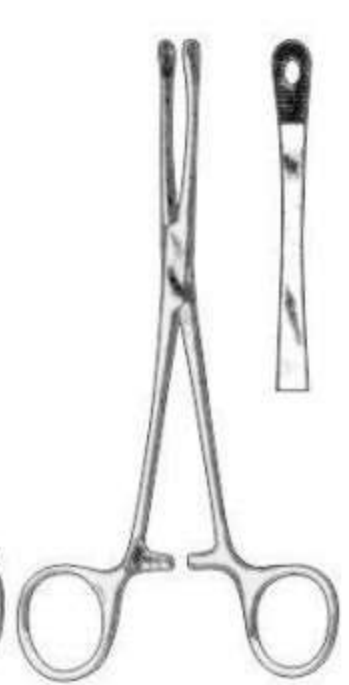

PERCY

13-210
24.0 cm, 9 1/4"



DENNIS-BROWN
13-220
18.0 cm, 7"

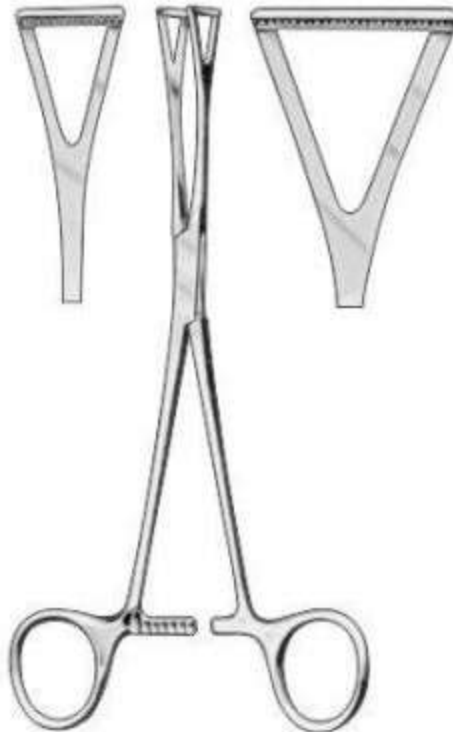

DUVAL
13-230 18cm 7"
13-231 20cm 8"



COLLIN
13-240
23.0 cm, 9"

INTESTINAL & TISSUE GRASPING FORCEPS

Darm-und Gewebefasszangen
Pinzas Para Intestinos y Tejidos

Pinces Pour Saisir Intestins et Tissus
Pinze Per Afferrare Intestino e Tessuti

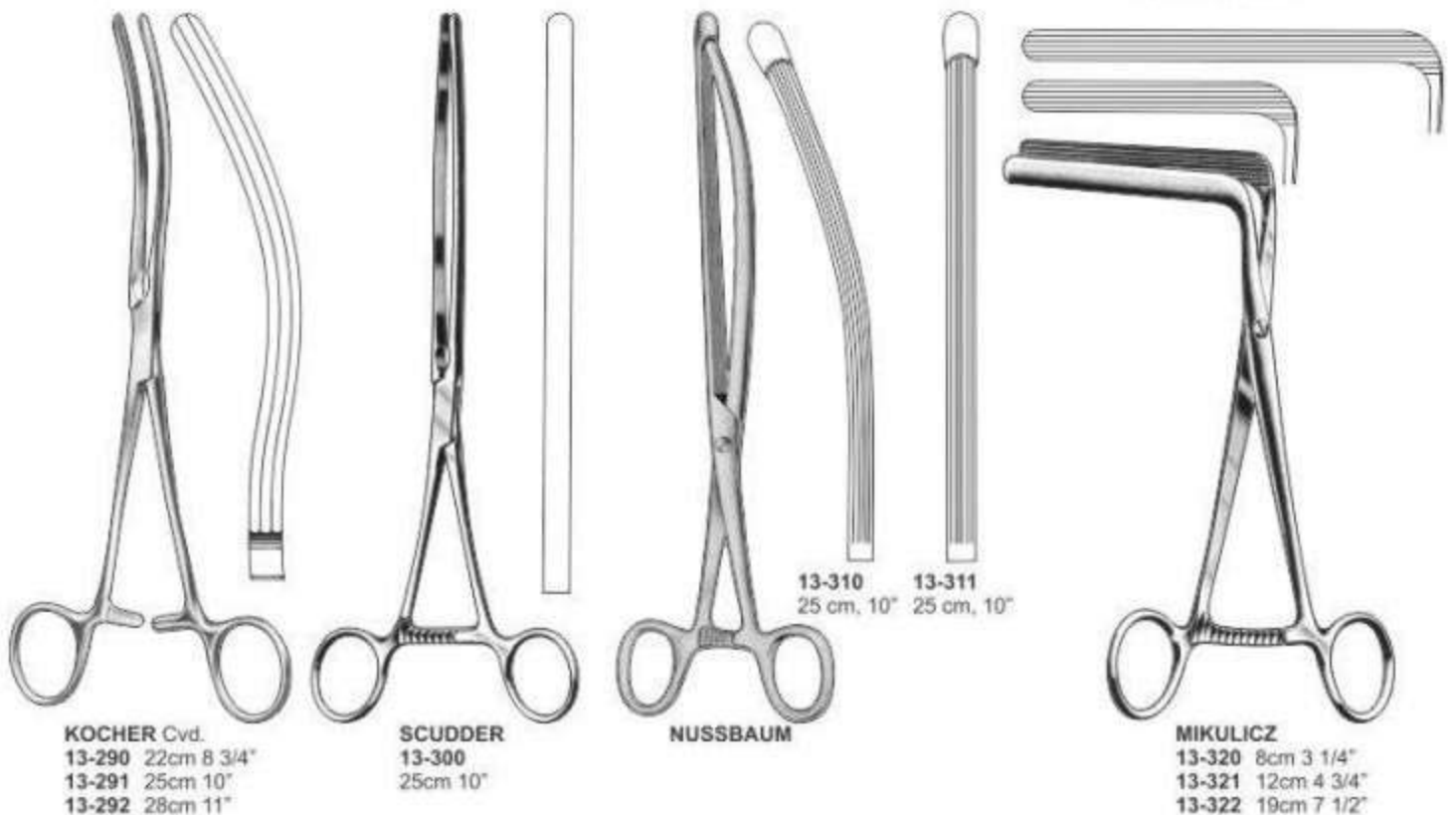
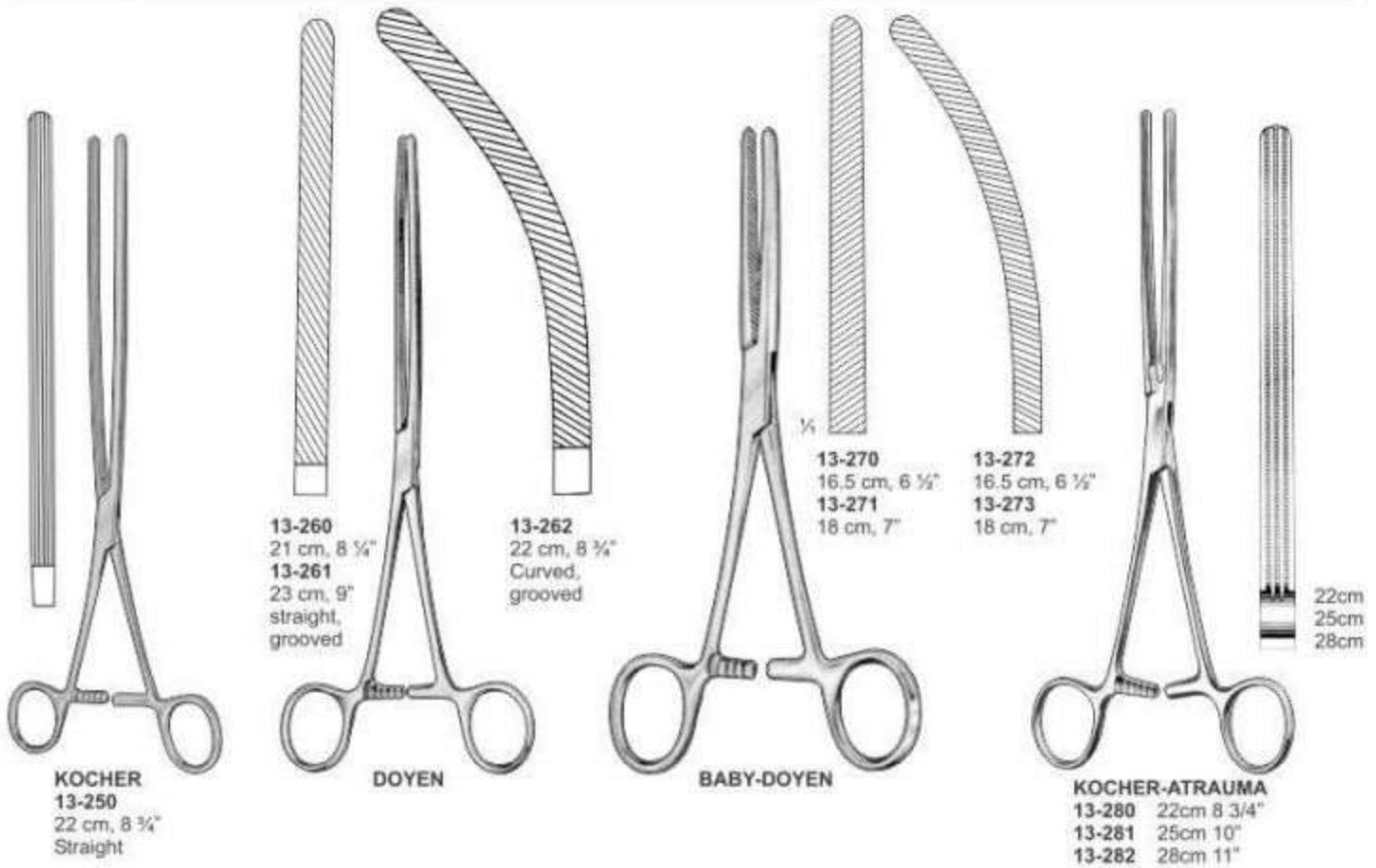

INTESTINAL & TISSUE GRASPING FORCEPS

Darm-und Gewebefasszangen
Pinzas Para Intestinos y Tejidos

Pinces Pour Saisir Intestins et Tissus
Pinze Per Afferrare Intestino e Tessuti



LANE Cvd.
13-330
30 cm, 12"

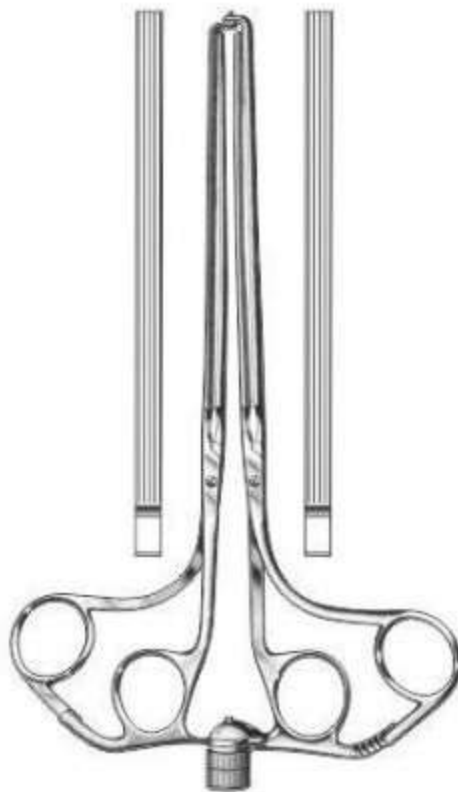

ABADIE
13-340
22cm 8 3/4"
13-341
27cm 10 1/2"



LANE
13-350
30 cm, 12"



LANE Cvd.
13-360
30 cm, 12"



PAYR-BABY
13-370
15 cm, 6"
without pin
13-371
15 cm, 6"
with pin



PAYR
13-380
21 cm, 8 1/4"
without pin
13-381
21 cm, 8 1/4"
with pin



PAYR
13-390
29 cm, 11 1/2"
without pin
13-391
29 cm, 11 1/2"
with pin

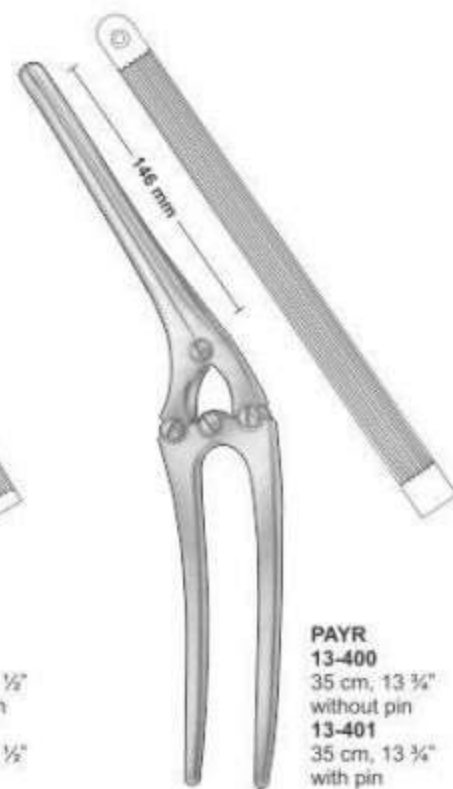

PAYR
13-400
35 cm, 13 3/4"
without pin
13-401
35 cm, 13 3/4"
with pin

INTESTINAL RECTAL SPECULA

Mastdarmspekula
Especulos Rectales

Spéculums Rectaux
Specoli Rettali

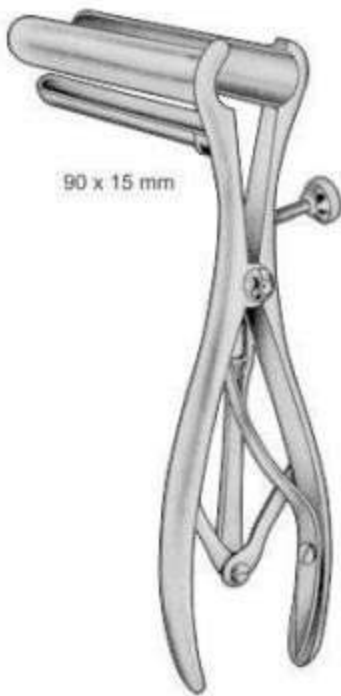

90 x 15 mm

MATHIEU
13-410
19.5 cm, 7 3/4"
90 x 15 mm



SIMS
13-420
15 cm, 6"



SIMS
13-430
15 cm, 6"



Sims
13-440
15 cm, 6"



13-450
22 ø x 50 mm
13-451
22 ø x 100 mm
13-452
22 ø x 140 mm
13-453
22 ø x 200 mm

KELLY



GABRIEL
13-460 64 x 24 mm
13-461 64 x 19 mm

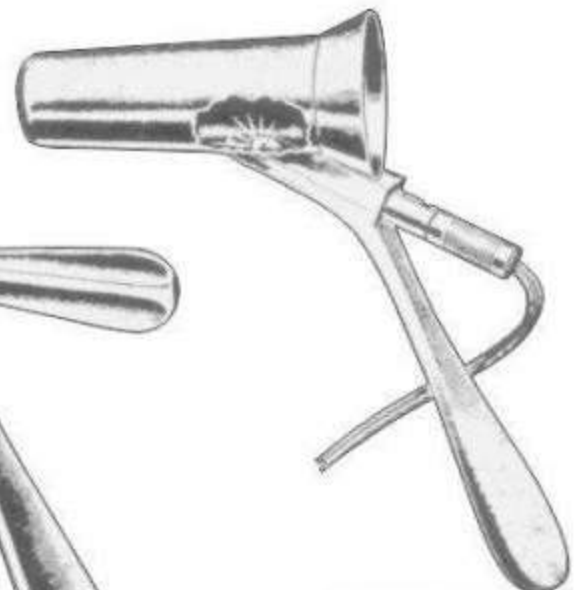

NAUTON-MORGAN
13-470 64 x 24 mm
13-471 64 x 19 mm

POLYOUS GRASPING FORCEPS, ANASTOMOSIS

Polypenfasszange, Darm-anastomosenklemmen

Pince Pour Saisir Polypes, Pincés-clamps Pour Anastomose Intestinale

Pinza Para Coger Pólipos, Clamps Para Anastomosis Intestinales

Pinze Per Afferrare Polipi, Pinze Per Anastomosi Intestinali

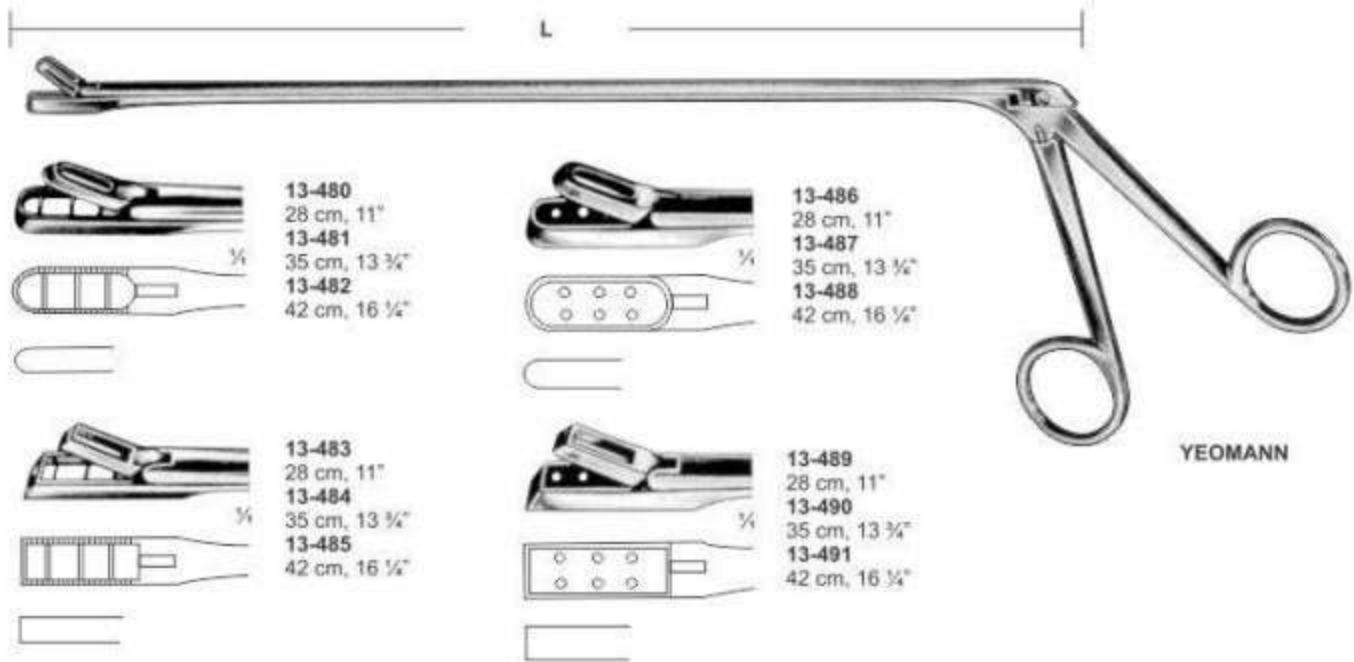

PILE FORCEPS

COTTON CARRIER



LURE
13-500 24.5cm



JARVIS
13-510 23cm



LANGENBECK
13-520 45cm



13-530 45cm

GALL STONE FORCEPS

Gallensteinzangen
Gallensteinlöffel

Pinces pour calculs biliaires
Curettes pour calculs biliaires

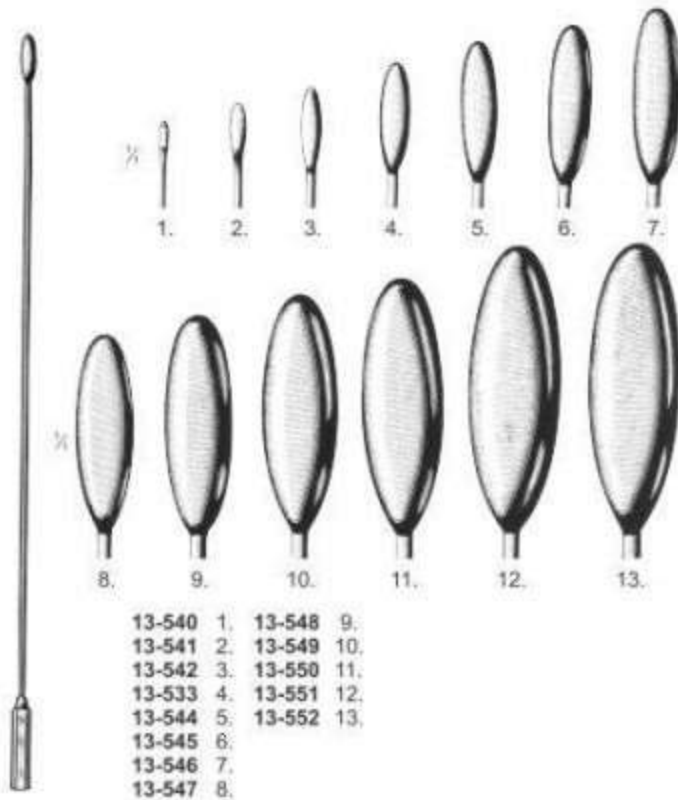

- | | | | |
|--------|----|--------|-----|
| 13-540 | 1. | 13-548 | 9. |
| 13-541 | 2. | 13-549 | 10. |
| 13-542 | 3. | 13-550 | 11. |
| 13-533 | 4. | 13-551 | 12. |
| 13-544 | 5. | 13-552 | 13. |
| 13-545 | 6. | | |
| 13-546 | 7. | | |
| 13-547 | 8. | | |

BAKES
30cm 12"

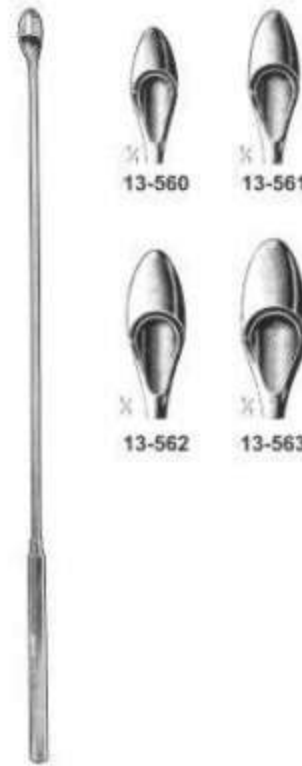

DESJARDINS
30cm 12"



MAYO
13-570
28cm 11"



BLAKE
13-580
20cm 8"

13-581



MAYO-BLAKE
13-590
20cm 8"



DESJARDINS
13-600
23cm 9"

URETHRAL CATHETERS

Urethralkatheter
Sondes Urétrales

Cateteri Uretrali
Catéteres Uretrales

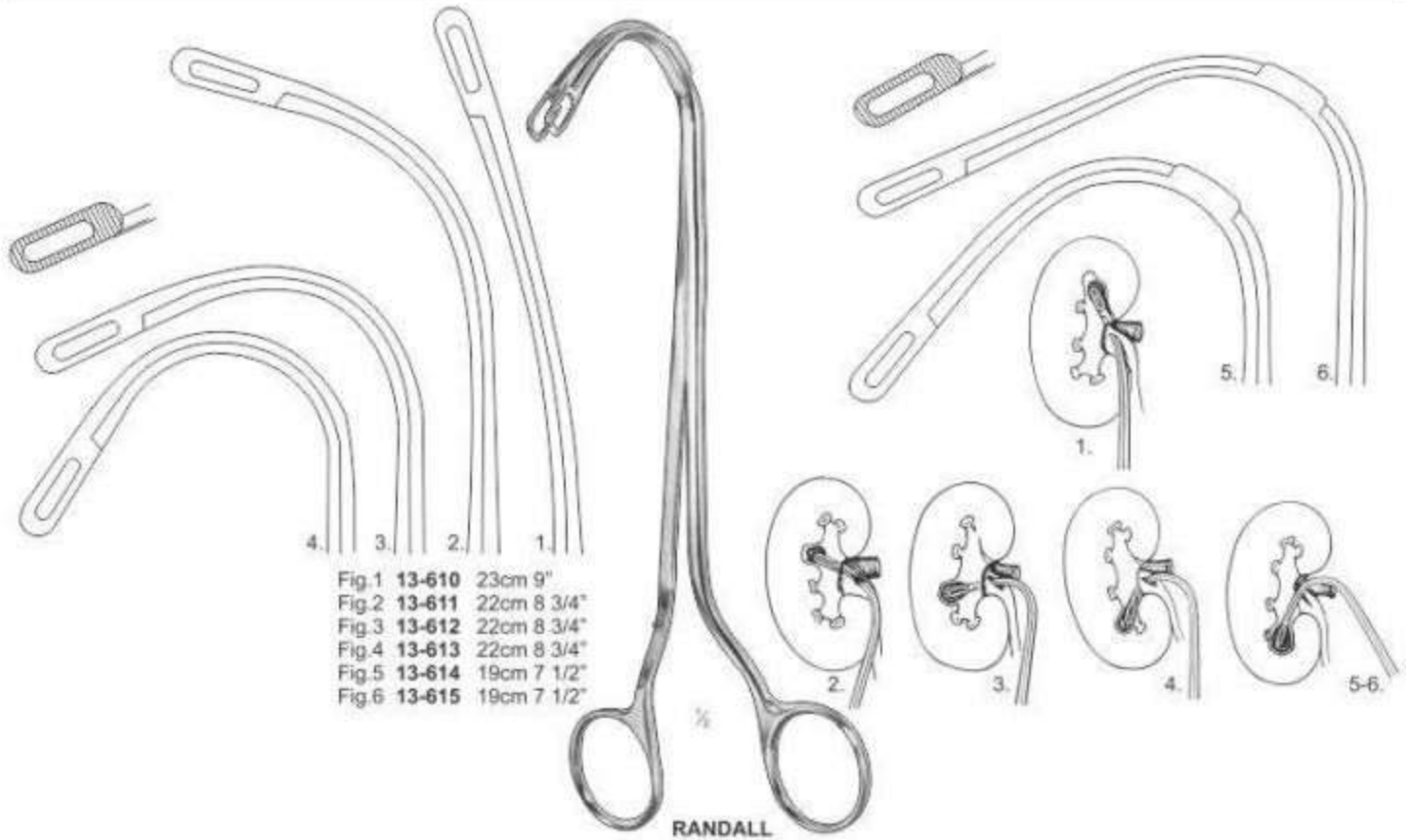

Fig.1 13-610 23cm 9"
Fig.2 13-611 22cm 8 3/4"
Fig.3 13-612 22cm 8 3/4"
Fig.4 13-613 22cm 8 3/4"
Fig.5 13-614 19cm 7 1/2"
Fig.6 13-615 19cm 7 1/2"

RANDALL



CATHETER
13-620
15 cm, 6"
No. 6-16



CATHETERS
13-630 29 cm, 11 1/2"
Male Catheters charr., Metal
French
13-631 8
13-632 10
13-633 12
13-634 14
13-635 16
13-636 18
13-637 20



COXETER
13-640 28 cm
8 Fg To 24 Fg



13-650 20 cm
8 Fg To 24 Fg

URETHRAL CATHETERS

Urethalkatheter
Sondes Urétrales

Cateteri Uretrali
Catéteres Uretrales

Urethral Bougies

Directors



LISTER
13-660
00/1 to 15/18



CLUTTON
13-670
8/10fg. To 28/32f.g



STONE
13-680
6eg. To 12eg



WHEELHOUSE
13-690



CHILD
13-700



KEY
13-710



LEWKOWITZ
13-720 26 cm
13-721 26 cm



13-722
26 cm

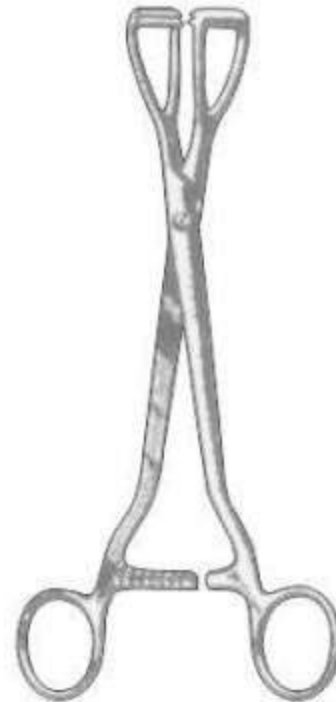

YOUNG
13-730 20 cm

BLADDER NECK SPREADER, BLADDER RETRACTORS

Blasenhalsperrerr, Blasenwundsperrerr

Ecarteur pour le col de la vessie, Ecarteurs vésicaux

Dilatador para el cuello vesical, Separadores vesicales

Divaricatore del collo vescicale, Divaricatore vescicale

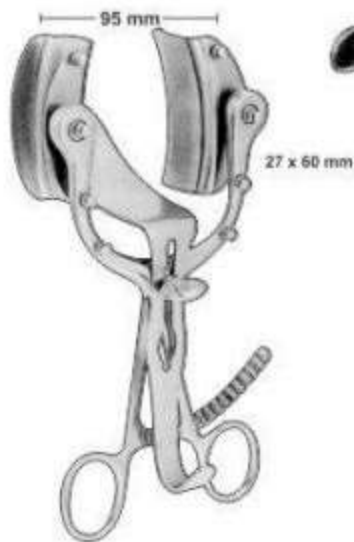

LEGUEU
13-740
17 cm, 6 1/4"

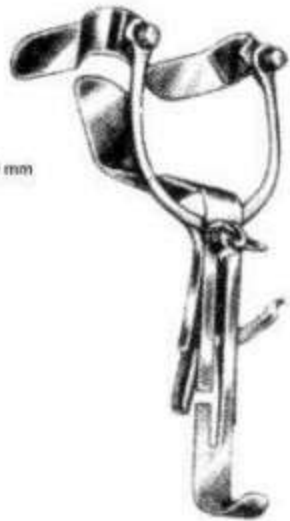

MILLIN
13-750



MILLIN
13-760
28 cm, 11"



KNUTSON
13-770
18 cm, 7"
Urethrographie-Instruments

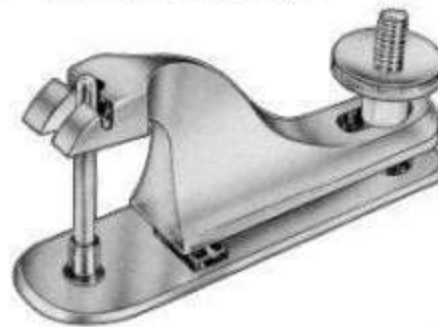

GUMCO CLAMP	mm Ø
13-780	8
13-781	11
13-782	13
13-783	16
13-784	21
13-785	26
13-786	32

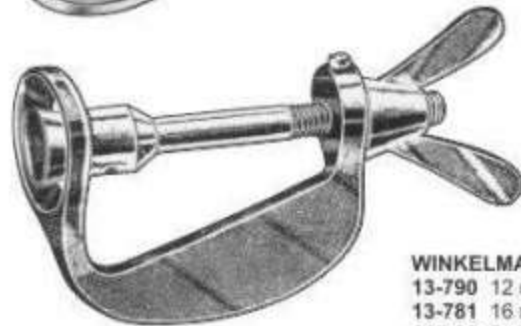

WINKELMANN
13-790 12 mm Ø
13-781 16 mm Ø
13-782 20 mm Ø
Circumcision clamps



MILLIN
13-900
23 cm, 9"



MILLIN
13-910
23 cm, 9"

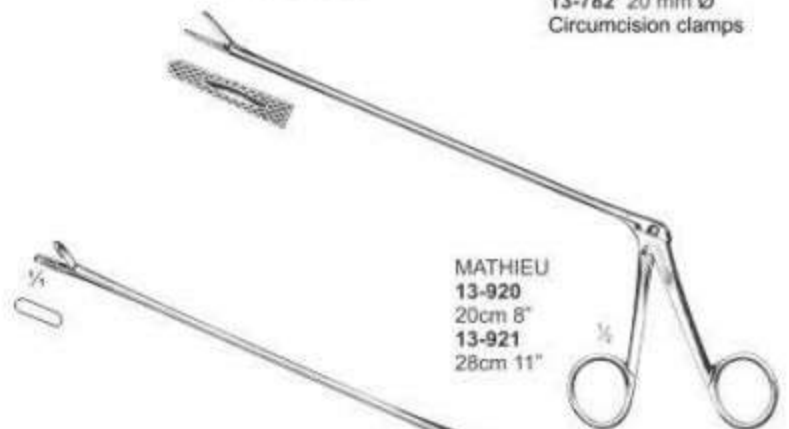

MATHIEU
13-920
20cm 8"
13-921
28cm 11"

MATHIEU
13-930
20cm 8"
13-931
28cm 11"

VAGINAL SPECULA

Vaginalspekula
Especulos vaginales

Spéculums vaginaux
Specoli vaginali



CUSCO
14-100 75 x 32 mm
14-101 85 x 35 mm
14-102 100 x 35 mm



CUSCO
14-105 90 x 22 mm
14-106 100 x 25 mm
14-107 105 x 27 mm

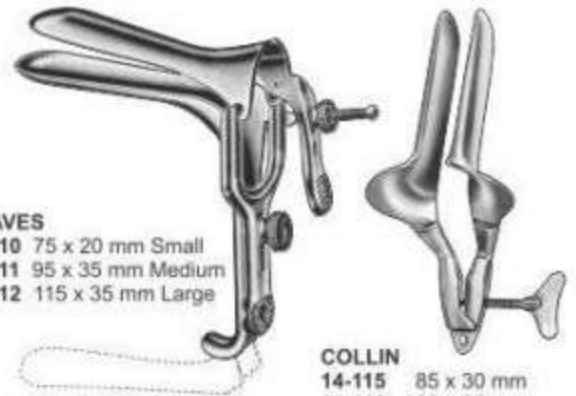

GRAVES
14-110 75 x 20 mm Small
14-111 95 x 35 mm Medium
14-112 115 x 35 mm Large

COLLIN
14-115 85 x 30 mm
14-116 100 x 35 mm
14-117 110 x 40 mm

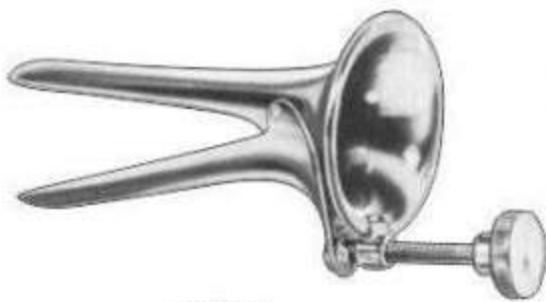

COLLIN
14-120
55 x 10 mm



WINTERTON
14-122



PEDERSON
14-125
75 x 13 mm Small
14-126
100 x 22 mm Medium
14-127
120 x 25 mm Large



Graves Vaginal Speculum Leep / Lietz
14-130 Small
14-131 Medium
14-132 Large
14-133 X-large



Pederson Vaginal Speculum Leep / Lietz
14-135 Small
14-136 Medium
14-137 Large
14-138 X-Large



CUSCO
14-140 Small
14-141 Medium
14-142 Large



SAKURAS
14-150 Small
14-151 Medium
14-152 Large

VAGINAL SPECULA

Vaginalspekula
Especulos vaginales

Spéculums vaginaux
Specoli vaginali



KRISTELLER
14-160 110x18 mm
14-161 110x20 mm
14-162 110x27 mm
14-163 110x30 mm
14-164 110x36 mm
22.0 cm,



14-171
80 x 28 mm

14-172
85 x 35 mm

14-173
85 x 40 mm

KRISTELLER
14-170
20.5 cm, 8"

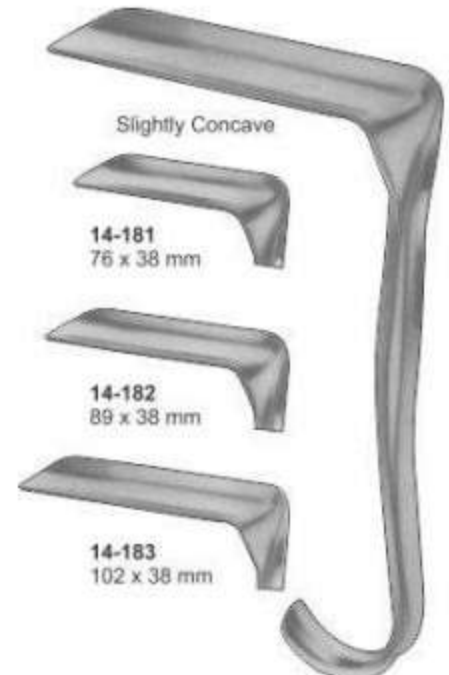

14-181
76 x 38 mm

14-182
89 x 38 mm

14-183
102 x 38 mm

JACKSON
14-180
17.5 cm, 7"



DOYEN
14-190
23.5 cm, 9 1/4"

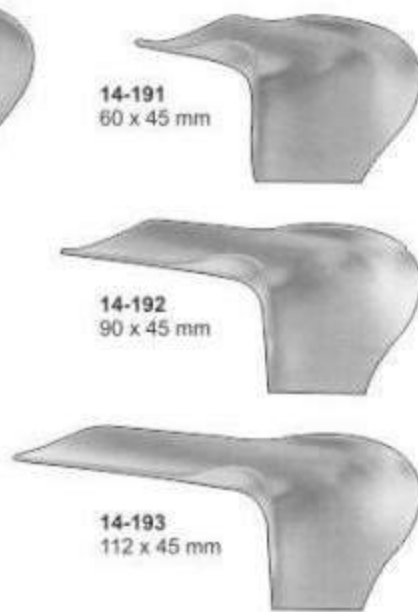

14-191
60 x 45 mm

14-192
90 x 45 mm

14-193
112 x 45 mm



SIMS-KELLY
14-200 57 x 25 mm
14-201 69 x 45 mm
14-202 76 x 38 mm
24 cm, 9 1/2"



SIMS
14-210 Small
14-211 Medium
14-212 Large

VAGINAL SPECULA

Vaginalsepekula
Espéculos vaginales

Spéculums vaginaux
Specoli vaginali



AUVARD
14-220
65 x 38 mm - 28 mm
1,530 kg
with fixed weight
23 cm, 9"



AUVARD
14-230 75 x 42 mm
(40 mm)
14-231 105 x 43 mm
(40 mm)
with detachable weight
23 cm, 9"



AUVARD
14-240 2 1/2" Lbs
14-241 3 Lbs



14-250
80 x 30 mm

14-251
65 x 30 mm

14-252
85 x 33 mm

14-253
75 x 35 mm

14-254
100 x 38 mm

14-255
85 x 35 mm

14-256
110 x 42 mm

14-257
95 x 35 mm

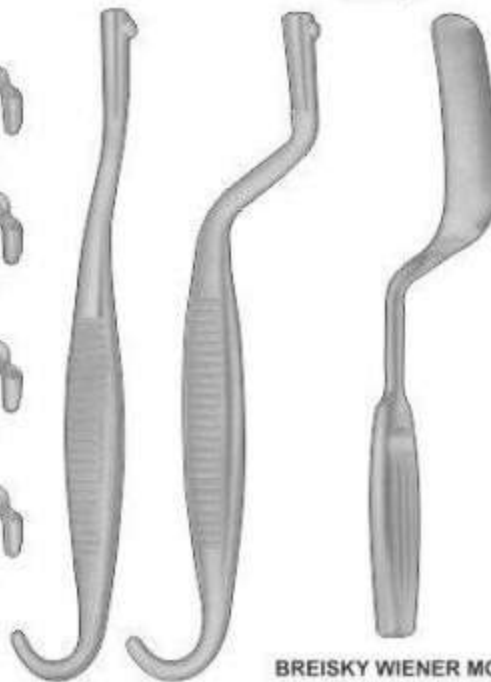

SCHERBACK
14-258
Set consisting of:
2 handle
8 blades

**BREISKY WIENER MODELL/
VIENNA PATTERN**
14-270 100 x 20 mm
14-271 100 x 25 mm
14-272 100 x 30 mm
14-273 100 x 35 mm
14-274 100 x 40 mm
30 cm, 12"



LANDAU
14-280 105 x 28 mm
14-281 105 x 38 mm
30 cm, 12"



FRIEDMANN
14-290
10 cm, 4"

UTERINE DILATORS

*Uterusdilatoren
Dilatadores uterinos*

*Dilatateurs du col de l'utérus
Dilatatori uterini*



PRATT GYNE
14-300
Set of 8 Double ended
size 13/14 thru 41/43
4.5/5.0mm thru 13.6/14.3mm



14-310 Set of 14 dilators
(4.0 - 17.0 mm), in leather pouch
with removable, washable canvas
lining, with zip fastener

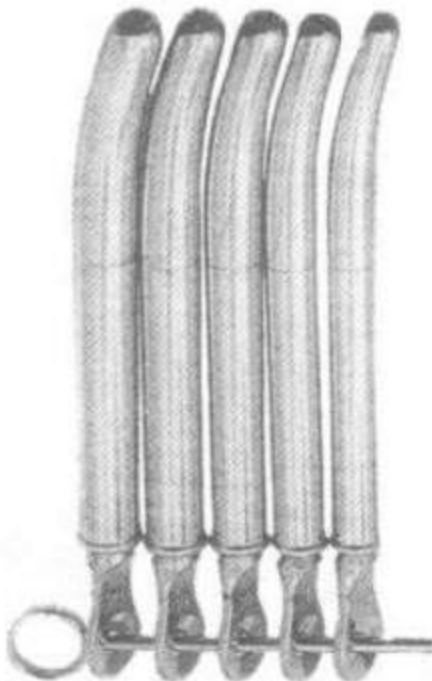

DILATORS SET
14-320
Set of 5 dilators

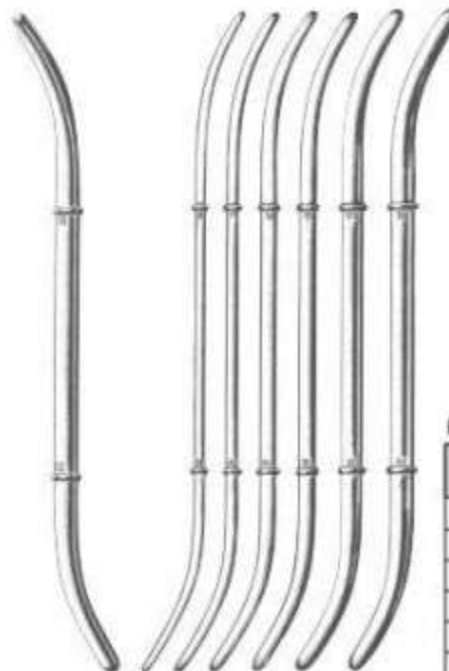

Hank with conical point double ended

Fig.	mmØ	Hank
9/10	4.5/5	14-330
11/12	5.5/6	14-331
13/14	6.5/7	14-332
15/16	7.5/8	14-333
17/18	8.5/9	14-334
19/20	9.5/10	14-335

UTERINE DILATORS, UTERINE SOUNDS

Uterusdilatatoren, Uterussonden
Dilatadores uterinos, Histerómetros

Dilatateurs du col de l'utérus, Hystéromètres
Dilatatori uterini, Isterometri



WYLIE
14-340
29cm 11 1/2"
with graduated fixing
screw, smooth jaws



14-341
with graduated fixing
screw, smooth jaws



SIMS
14-350
29cm 11 1/2"
with fixing screw,
three-bladed, smooth jaws



GOODELL
14-360
29cm 11 1/2"
with graduated fixing
screw, serrated jaws



SIMS UTERINE
CURETTE
14-370
double ended, sharp
as above but blunt
25 cm, 10"
small, medium, large



SIMS
schwed. Modell
14-380
26 cm, 10 1/4"



MARTIN
14-390
30 cm, 12"



VALLEIX
14-400
25 cm, 10"



GALABIN
14-410
32 cm, 12 1/4"

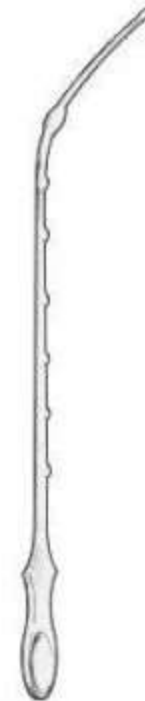

HORROCKS
UTERINE SOUND
14-420
32 cm, 12 1/4"



NOVAK "SUCTION
CANNULA CURETTE"
14-430
Luer cone,
25.4 cm, 10"

UTERINE TENACULUM FORCEPS

Hakenzangen, amniotom
Pinza para cuello uterino, amniótomo

Pince pour le col de l'utérus, amniotome
Pinza per il collo dell'utero, amniotomo

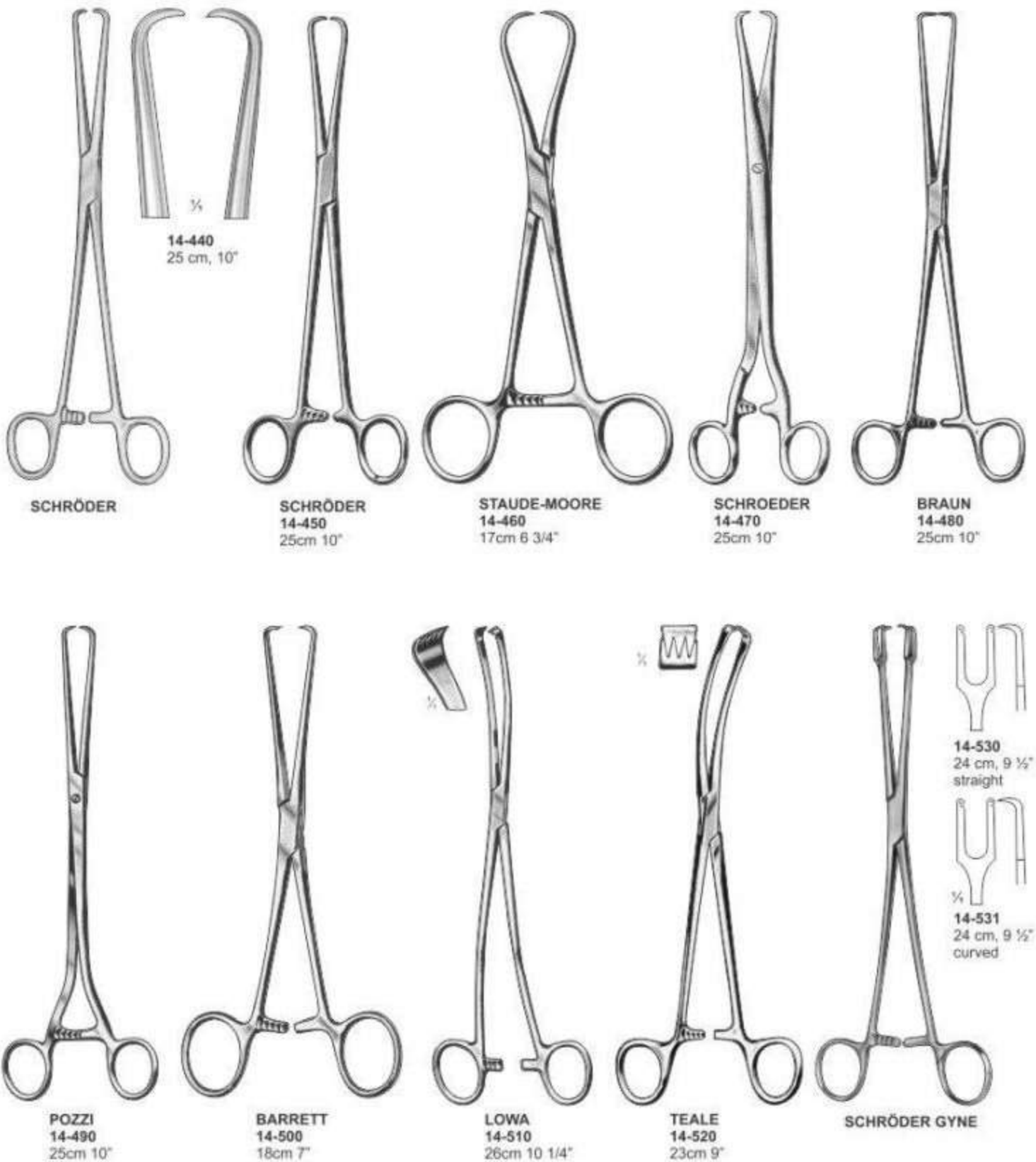

UTERINE TENACULUM FORCEPS

Hakenzangen, amniotom
Pinza para cuello uterino, amniótomo

Pince pour le col de l'utérus, amniotome
Pinza per il collo dell'utero, amniotomo

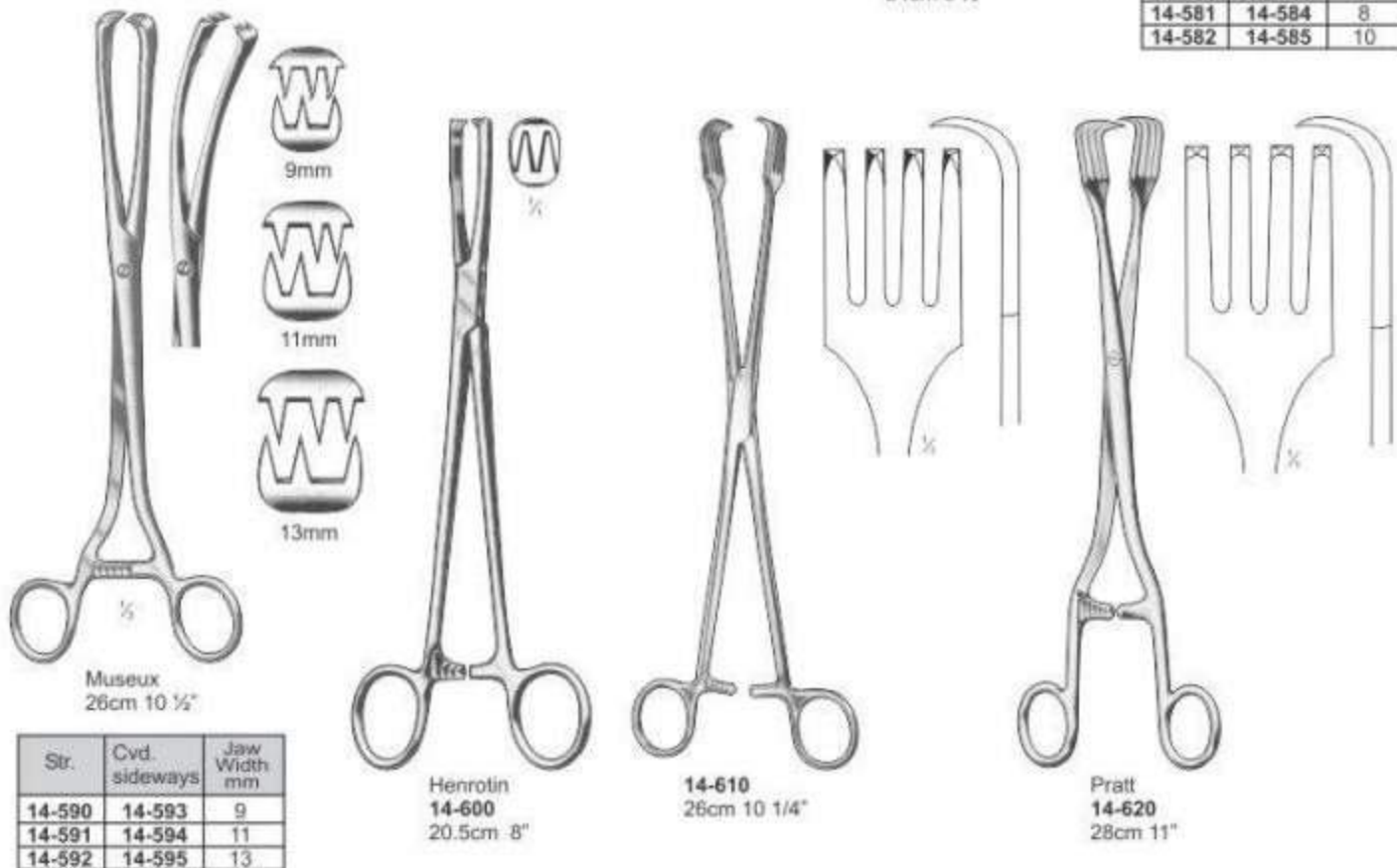
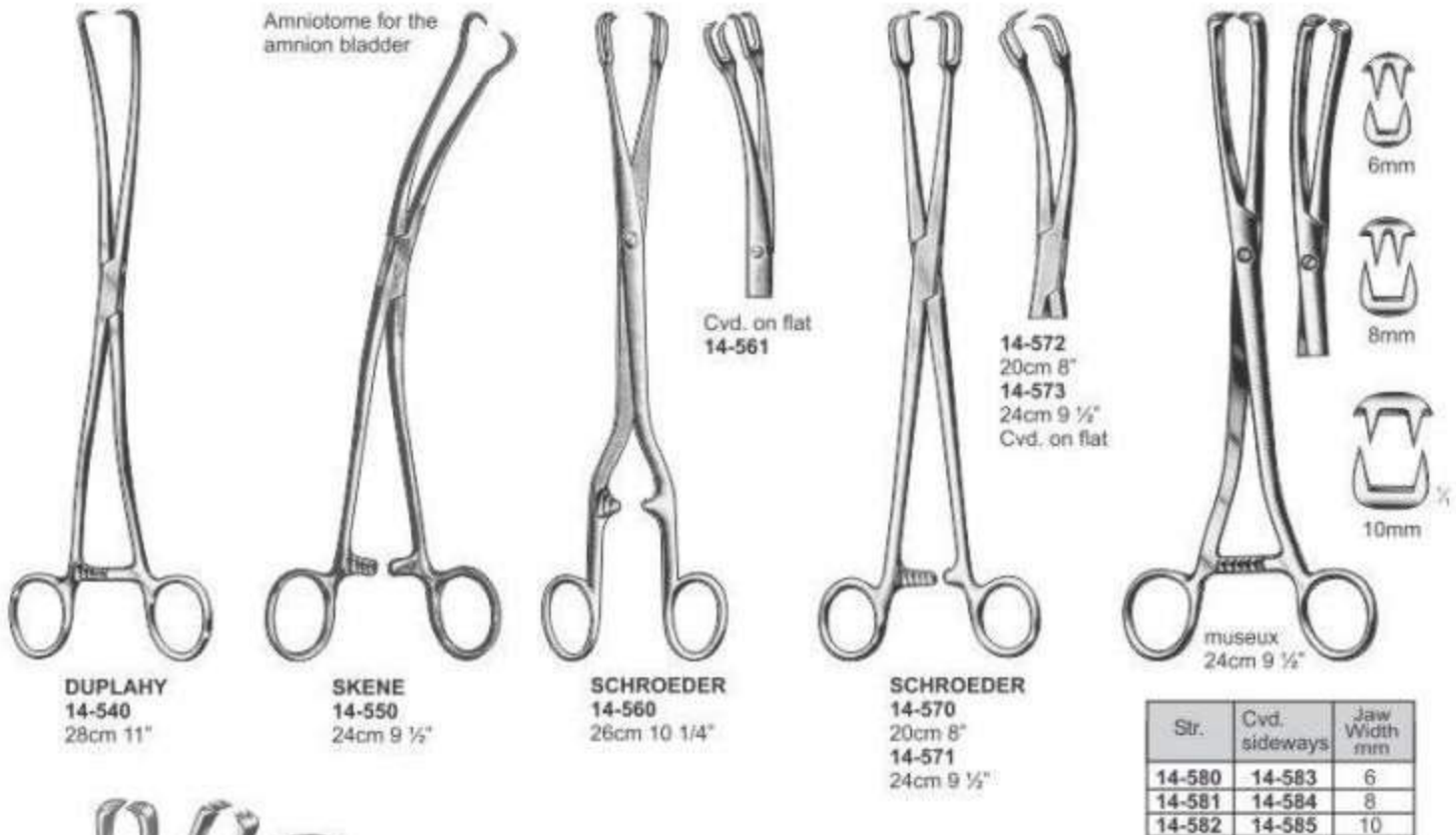

UTERINE TENACULUM FORCEPS

Hakenzangen, amniotom

Pinza para cuello uterino, amniótomo

Pince pour le col de l'utérus, amniotome

Pinza per il collo dell'utero, amniotomo



BRAUN
14-630
15.5cm 6 1/4"



CZERNY
14-640
20.5cm 8 1/4"



PRUESMANN
14-650
27.5cm 10 3/4"



COLLIN
14-660
25cm 10"



KELLY
14-670
32cm 12 1/2"



NOTO
14-680
27cm 10 1/2"



DARTIGUES
14-690
27cm 10 1/2"



SOMER
14-700
23cm 9"



GELLHORN
14-710
23cm 9"



FAURE
14-720
21cm 8 1/4"

UTERINE TENACULUM FORCEPS

Hakenzangen, amniotom
Pinza para cuello uterino, amniótomo

Pince pour le col de l'utérus, amniotome
Pinza per il collo dell'utero, amniotomo

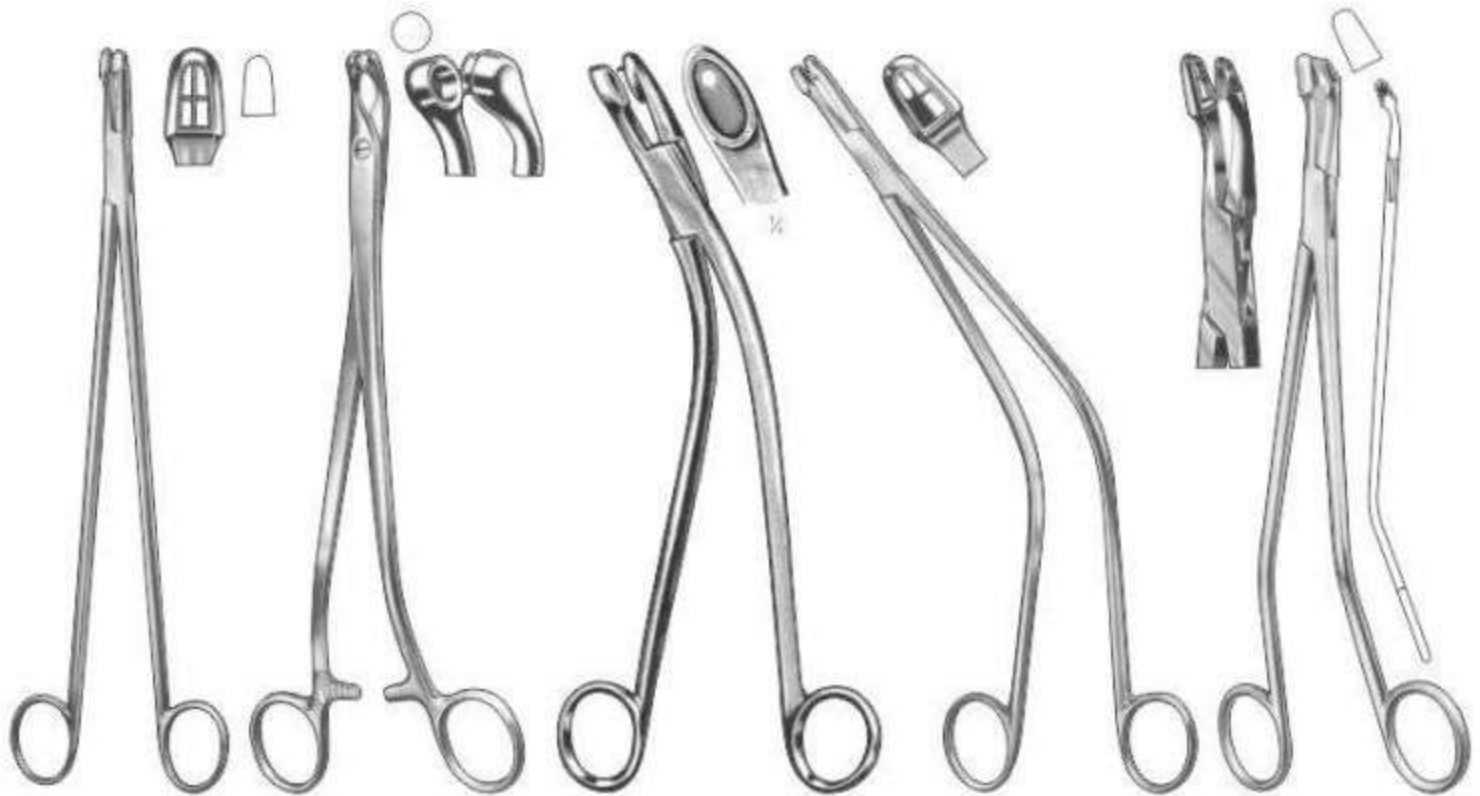

SCHUBERT
14-730 21cm 8 1/4"
14-731 29cm 11 1/2"

THOMS-GAYLOR
14-740
24cm 9 1/2"

GELLHORN
Biopsy Punch Forceps
14-750
24cm 9 1/2"

SCHUBERT
14-760
26cm 10 1/4"

VAN DOREN
14-770
25cm 10"

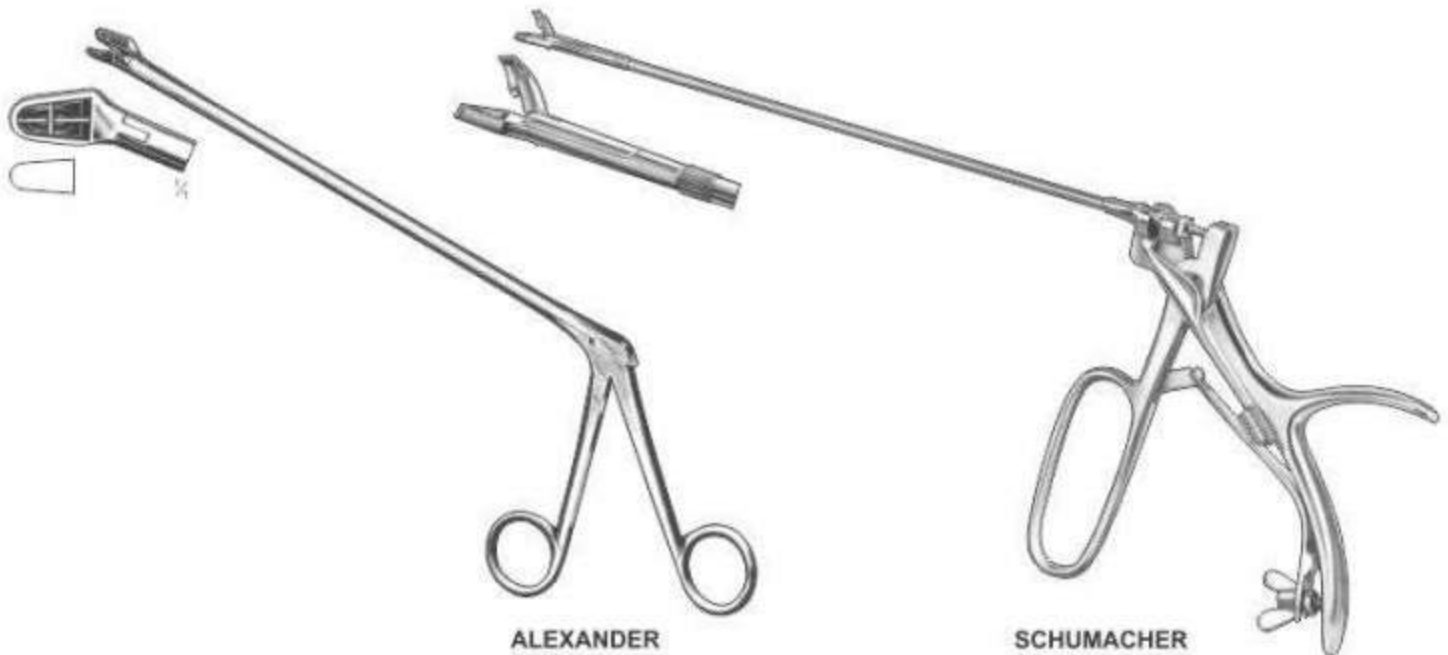

ALEXANDER
14-780
28cm 11"

SCHUMACHER
14-790
Forcep with
exchangeable tip

UTERINE SCOOPS, SUCTION CURETTES & UTERINE DEPRESSOR

Uteruslöffel, Absaugküretten, uterusdepressor

Curettes uterines, curettes d'aspiration, Dépresseur utérin

Cucharillas uterinas, Curetas aspiradoras, depresor uterino

Curette uterine, curette pe aspirazione, depressore uterino

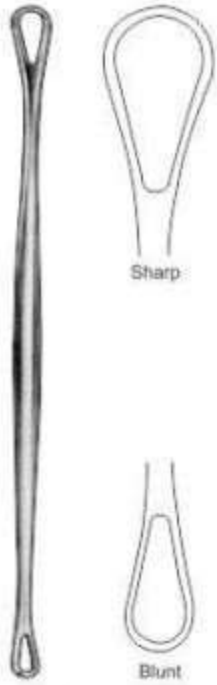

BLAKE
14-800
27 cm, 10 3/4"



ZWEIFEL
14-810
31 cm



SIMS
14-820
31cm 12 1/2"
malleable

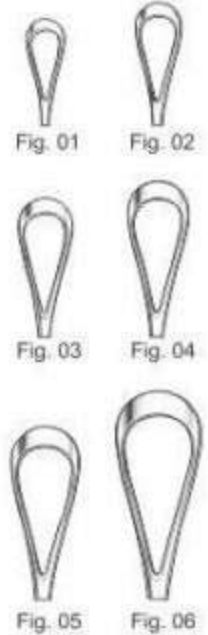

RECAMIER **RECAMIER**
14-830 14-840
26cm 31cm
malleable malleable

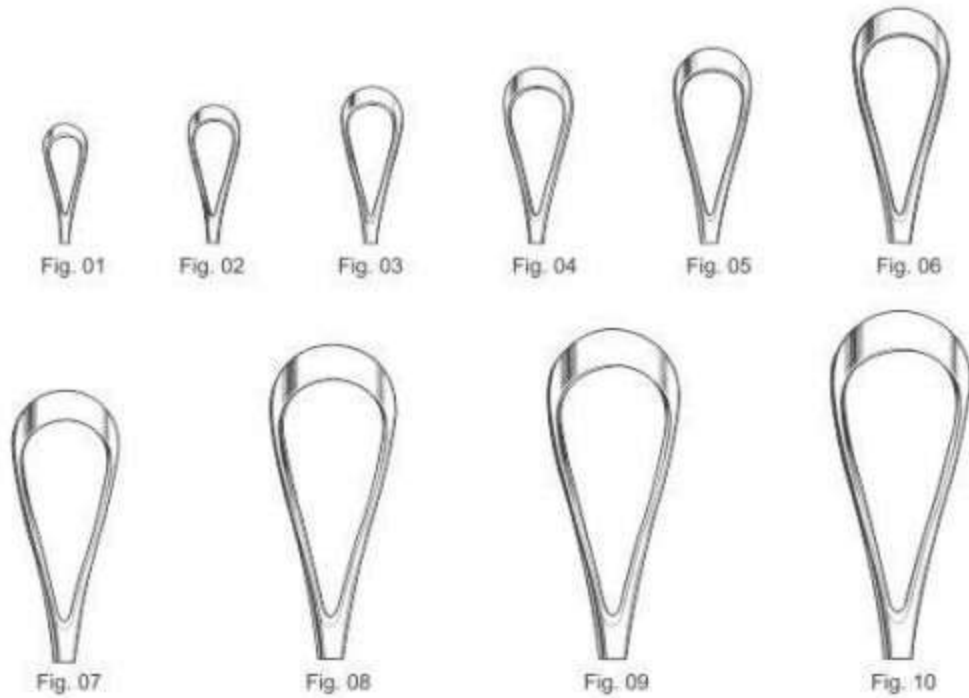

UTERINE SCOOPS, SUCTION CURETTES & UTERINE DEPRESSOR

Uteruslöffel, Absaugküretten, uterusdepressor
Cucharillas uterinas, Curetas aspiradoras, depresor uterino

Curettes uterines, curettes d'aspiration, Dépresseur utérin
Curette uterine, curette pe aspirazione, depressore uterino



SIMS
14-850
25cm

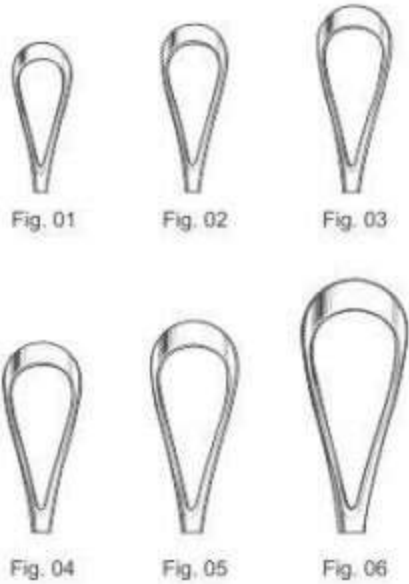

THOMAS
14-860
28cm

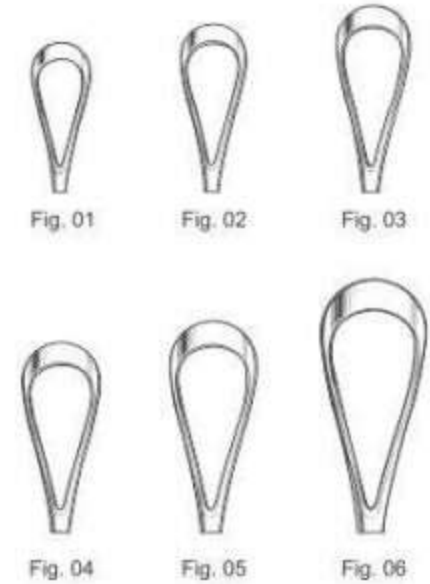

COLLIN
14-870
28cm 11"
Uterine sound with
slide & adjustable shaft



VALLEIX
14-880
25cm 10"
ditto, with slide



RANDALL
14-890
24cm 9 1/2"



NOVAK
14-900
23cm 9"
4mm ϕ

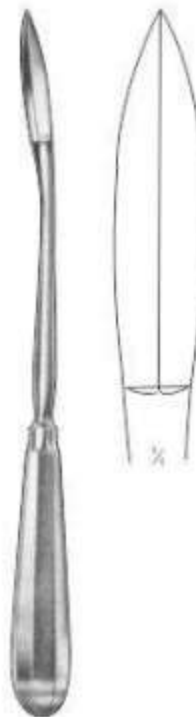

SEGOND
14-910



DOYEN
14-920
17cm 6 3/4"

OBSTETRICAL FORCEPS

Geburtszangen
Forceps obstétricos

Forceps obstétriques
Forcipi obstetrici



KIELLAND
14-930
41 cm, 16"



SIMPSON
14-940
30 cm, 12"

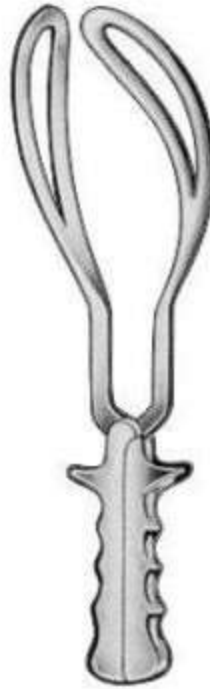

SIMPSON-BRAUN
14-950 33 cm, 13 1/2"
14-951 38 cm, 14 1/2"



DE LEE
14-960
30 cm, 12"

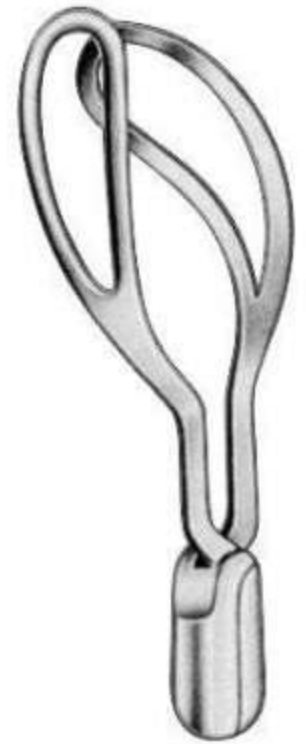

WRIGLEY
14-970
23 cm, 9"



DE LEE
14-980
30cm 12"



DE LEE
14-990
36cm 14"



ELLIOT
14-1000 32cm
14-1001 38cm



KIELLAND-LUIKART
14-1010
41 cm, 16"



NAEGELE
14-1020 36 cm, 14 1/2"
14-1021 40 cm, 15 3/4"



PIPER
14-1030
44 cm, 18"

OBSTETRICAL FORCEPS

Geburtszangen
Forceps obstétricos

Forceps obstétriques
Forcipi obstetrici



MCLEAN
14-1040
36 cm, 14 1/4"



SIMPSON-LUIKART
14-1050
36cm 14"



Mc LEAN-TUCKER
14-1060
39cm 15"



KEDARNATH DAS
14-1070
33cm



BOERMA
14-1080
29cm

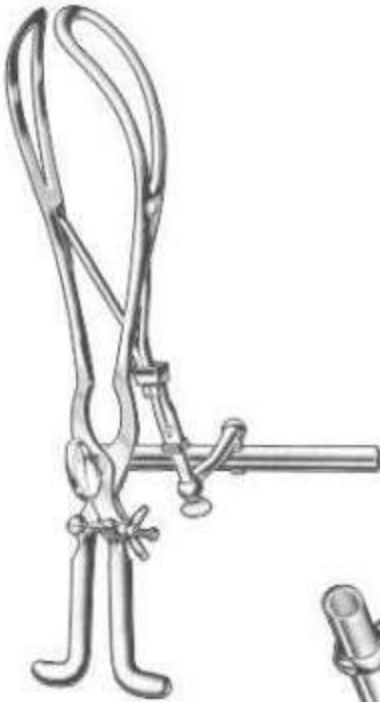

TARNIER
14-1090
40cm 15 3/4"
with traction handle



DEWEY
14-1100
37cm 14 1/2"
with traction handle



PIPER
14-1110
40cm 15 3/4"
with traction handle

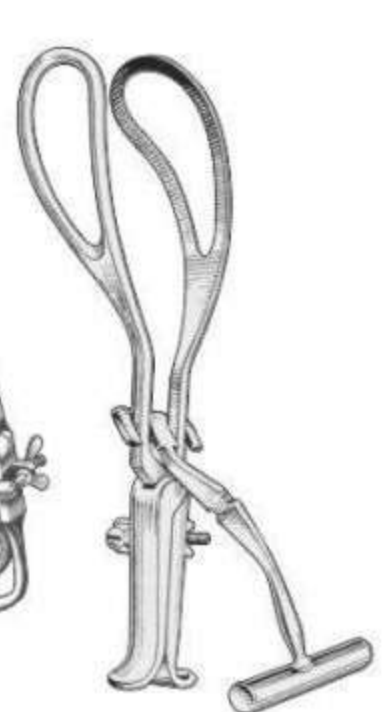

HAIG FERGUSON
14-1120
detachable axis traction
rod & handle.

OBSTETRICAL FORCEPS

Geburtszangen
Forceps obstétricos

Forceps obstétriques
Forcipi obstetrici

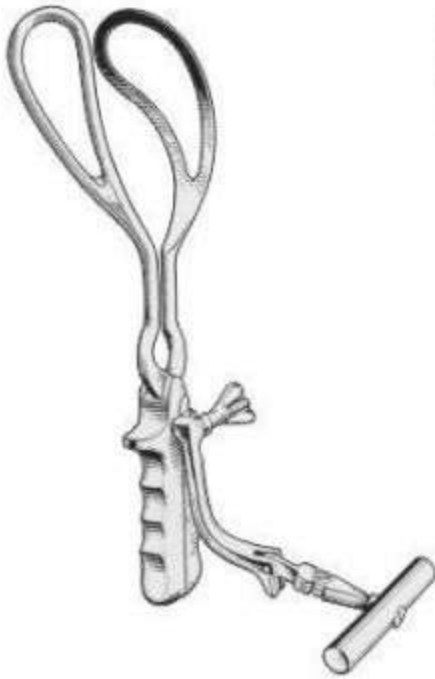

BARNES-NEVILLE
14-1130
Simpson handles, detachable
axis traction rod and handle.

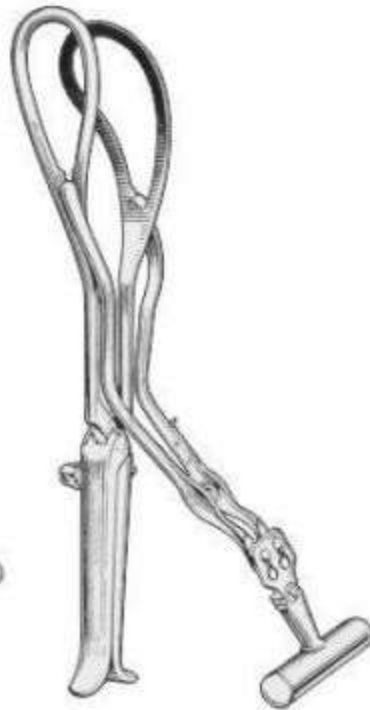

MILNE MURRAY
14-1140
detach-able axis traction
rod & handle.



BRAUN
14-1150
42 cm, 16 1/2"



TARNIER
14-1160
44 cm, 17 1/4"



LUIKART
14-1170
40cm 15 3/4"

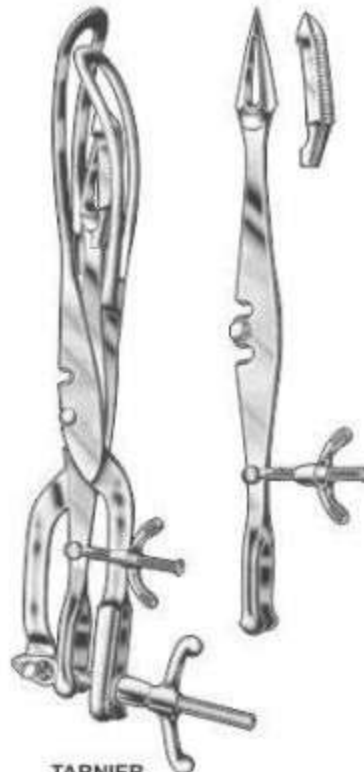

TARNIER
14-1180
46cm 18"



BRAUN
14-1190
42cm 16 1/2"

OBSTETRICAL FORCEPS

Geburtszangen
Forceps obstétricos

Forceps obstétriques
Forcipi obstetrici



NAEGELE
14-1200
25 cm, 10"



SMELLIE
14-1210
25 cm, 10"



BRAUN
14-1220
30 cm, 12"



SMELLIE
14-1230
30 cm, 12"



TARGET
14-1240
26cm



TARGET
14-1250
30cm



M-PELVIMETER
14-1260
34cm 13 1/2"
cm scale



M-PELVIMETER
14-1270
34cm 13 1/2"
in/cm scale



COLLIN
14-1280
35cm 13 3/4"
cm scale



COLLYER
14-1290
30cm 12"
cm/inch scale



BREISKY
14-1300
33cm 13"
cm/inch scale

OBSTETRICAL FORCEPS

Geburtszangen
Forceps obstétricos

Forceps obstétriques
Forcipi obstetrici

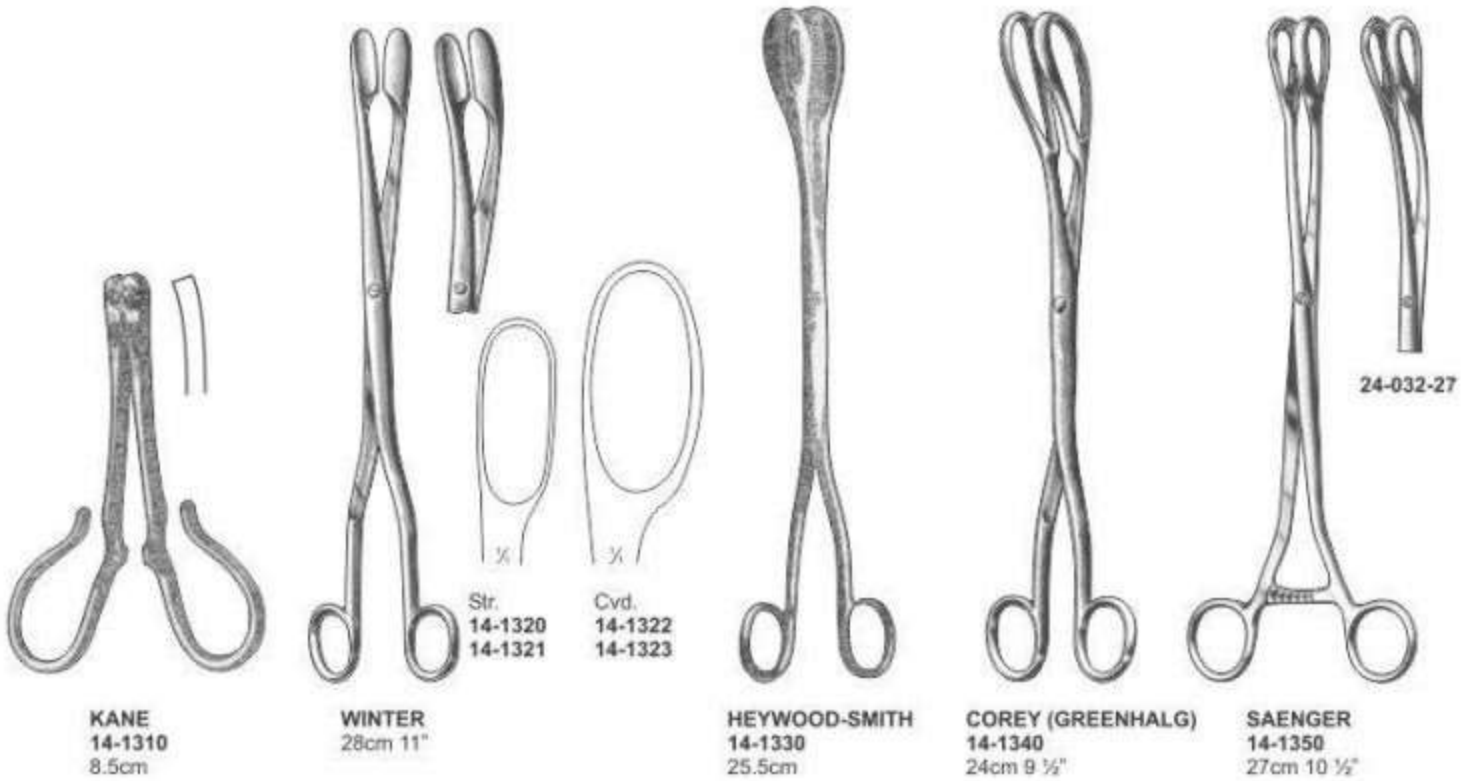

KANE
14-1310
8.5cm

WINTER
28cm 11"

HEYWOOD-SMITH
14-1330
25.5cm

COREY (GREENHALG)
14-1340
24cm 9 1/2"

SAENGER
14-1350
27cm 10 1/2"

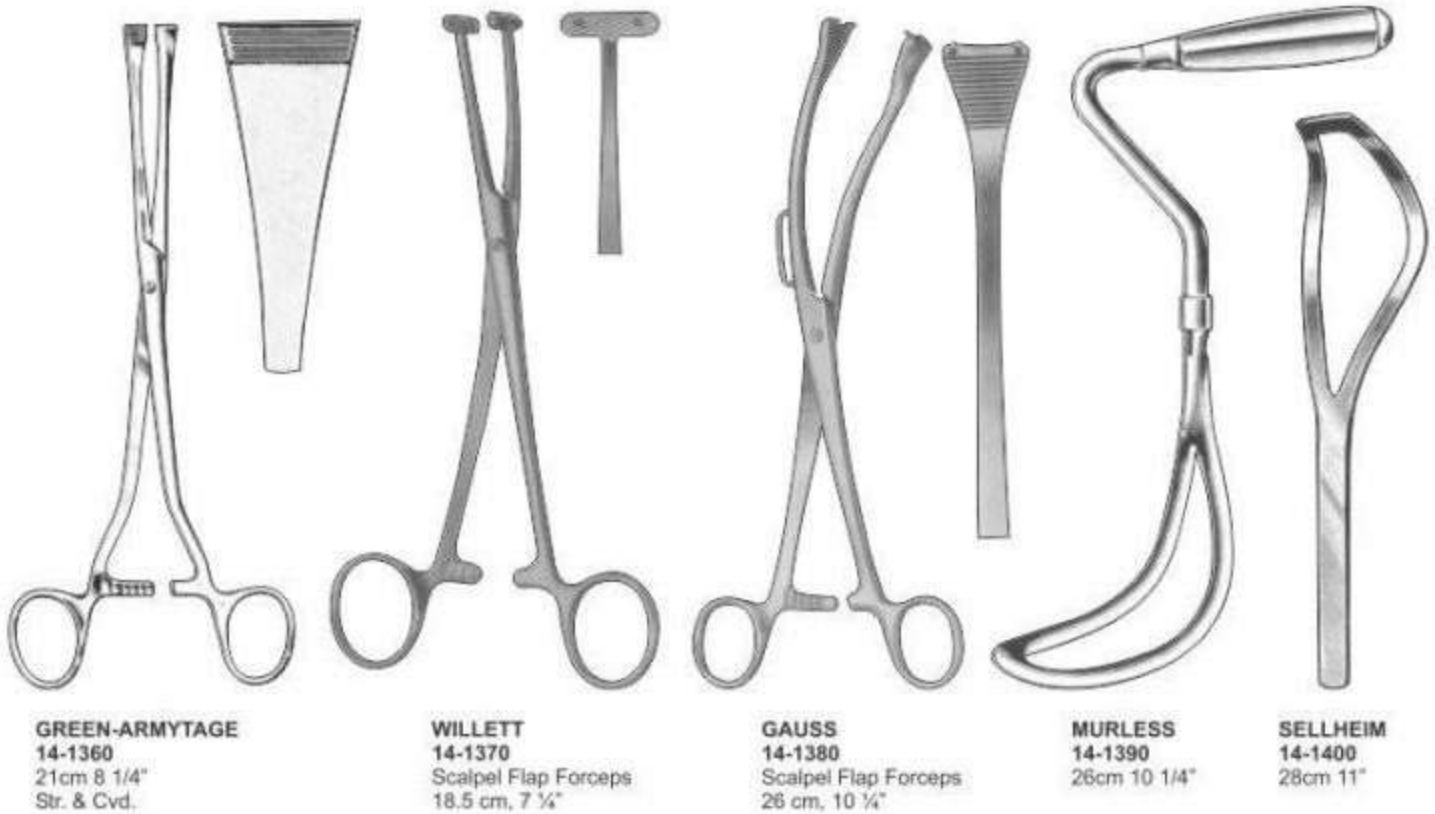

GREEN-ARMYTAGE
14-1360
21cm 8 1/4"
Str. & Cvd.

WILLETT
14-1370
Scalpel Flap Forceps
18.5 cm, 7 1/4"

GAUSS
14-1380
Scalpel Flap Forceps
26 cm, 10 1/4"

MURLESS
14-1390
26cm 10 1/4"

SELLHEIM
14-1400
28cm 11"

HOLLOW WARES



STERILIZING DRUMS

	Ø mm	h mm
15-100	80	80
15-101	120	120
15-102	160	120
15-103	190	140
15-104	190	200
15-105	240	120
15-106	240	160
15-107	240	240
15-108	290	120
15-109	290	160
15-110	290	240
15-111	340	160
15-112	340	240
15-113	390	145
15-114	390	200
15-115	390	290



STERILIZING DRUM

	Ø mm	h mm
15-120	150	150
15-121	175	175
15-122	190	190
15-123	200	140
15-124	200	200
15-125	240	120
15-126	225	225
15-127	240	240
15-128	290	160
15-129	280	240
15-130	230	150
15-131	300	250
15-132	340	250
15-133	350	250
15-134	390	200



STERILIZING DRUM

	Ø mm	h mm
15-140	150	150
15-141	175	175
15-142	190	190
15-143	200	140
15-144	200	200
15-145	240	120
15-146	225	225
15-147	240	240
15-148	290	160
15-149	280	240
15-150	230	150
15-151	300	250
15-152	340	250
15-153	350	250
15-154	390	200



STERILIZING DRUM

	Ø mm	h mm
15-160	150	150
15-161	175	175
15-162	190	190
15-163	200	140
15-164	200	200
15-165	240	120
15-166	225	225
15-167	240	240
15-168	290	160
15-169	280	240
15-170	230	150
15-171	300	250
15-172	340	250
15-173	350	250
15-174	390	200



STERILIZING DRUM

	Ø mm	h mm
15-180	150	150
15-181	175	175
15-182	190	190
15-183	200	140
15-184	200	200
15-185	240	120
15-186	225	225
15-187	240	240
15-188	290	160
15-189	280	240
15-190	230	150
15-191	300	250
15-192	340	250
15-193	350	250
15-194	390	200

HOLLOW WARES



G LOVES BOX
15-200
300 x 150 mm



INSTRUMENT TRAY WITH COVER
15-210



INSTRUMENT TRAY
15-220



CATHETER TRAY
Size
15-230 230 x 75 mm
15-231 350 x 90 mm
15-232 430 x 100 mm
15-233 200 x 100 mm
15-234 300 x 100 mm
15-235 350 x 100 mm

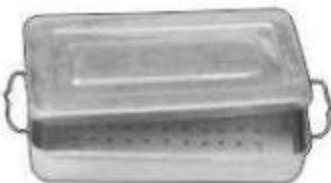

INSTRUMENT BOILER

	Size
15-240	180 x 80 x 40 mm
15-241	200 x 100 x 50 mm
15-242	250 x 125 x 40 mm
15-243	300 x 150 x 60 mm
15-244	350 x 175 x 75 mm
15-245	400 x 200 x 100 mm



PERFORATED TRAY

	Size
15-250	180 x 80 x 40 mm
15-251	200 x 100 x 50 mm
15-252	250 x 125 x 40 mm
15-253	300 x 150 x 60 mm
15-254	350 x 175 x 75 mm
15-256	400 x 200 x 100 mm



INSTRUMENT BOILER WITH STAND

	Size
15-260	180 x 80 x 40 mm
15-261	200 x 100 x 50 mm
15-262	250 x 125 x 40 mm
15-263	300 x 150 x 60 mm
15-264	350 x 175 x 75 mm
15-265	400 x 200 x 100 mm



INSTRUMENT BOILER ELECTRIC

	Size
15-270	180 x 80 x 40 mm
15-271	200 x 100 x 50 mm
15-272	250 x 125 x 40 mm
15-273	300 x 150 x 60 mm
15-274	350 x 175 x 75 mm
15-275	400 x 200 x 100 mm



PERFORATED BOX

	Size
15-280	100 x 50 mm
15-281	165 x 65 mm
15-282	250 x 100 mm
15-283	250 x 150 mm
15-284	250 x 200 mm
15-285	150 x 65 mm
15-286	170 x 70 mm
15-287	200 x 100 mm
15-288	250 x 125 mm
15-289	300 x 150 mm
15-290	300 x 200 mm
15-291	300 x 130 mm
15-292	320 x 150 mm
15-293	420 x 180 mm
15-294	460 x 125 mm
15-295	355 x 180 mm
15-296	300 x 180 mm
15-297	400 x 200 mm
15-298	510 x 200 mm



BOX WITH FILTER

	Size
15-310	100 x 50 mm
15-311	165 x 65 mm
15-312	250 x 100 mm
15-313	250 x 150 mm
15-314	250 x 200 mm
15-315	150 x 65 mm
15-316	170 x 70 mm
15-317	200 x 100 mm
15-318	250 x 125 mm
15-319	300 x 150 mm
15-320	300 x 200 mm
15-321	300 x 130 mm
15-322	320 x 150 mm
15-323	420 x 180 mm
15-324	460 x 125 mm
15-325	355 x 180 mm
15-326	300 x 180 mm
15-327	400 x 200 mm
15-328	510 x 200 mm



INSTRUMENTS BOX
Without Clip

	Size
15-340	100 x 50 mm
15-341	165 x 65 mm
15-342	250 x 100 mm
15-343	250 x 150 mm
15-344	250 x 200 mm
15-345	150 x 65 mm
15-346	170 x 70 mm
15-347	200 x 100 mm
15-348	250 x 125 mm
15-349	300 x 150 mm
15-350	300 x 200 mm
15-351	300 x 130 mm
15-352	320 x 150 mm
15-353	420 x 180 mm
15-354	460 x 125 mm
15-355	355 x 180 mm
15-356	300 x 180 mm
15-357	400 x 200 mm
15-358	510 x 200 mm



INSTRUMENT BOX
With Clip

	Size
15-370	100 x 50 mm
15-371	165 x 65 mm
15-372	250 x 100 mm
15-373	250 x 150 mm
15-374	250 x 200 mm
15-375	150 x 65 mm
15-376	170 x 70 mm
15-377	200 x 100 mm
15-378	250 x 125 mm
15-379	300 x 150 mm
15-380	300 x 200 mm
15-381	300 x 130 mm
15-382	320 x 150 mm
15-383	420 x 180 mm
15-384	460 x 125 mm
15-385	355 x 180 mm
15-386	300 x 180 mm
15-387	400 x 200 mm
15-388	510 x 200 mm

HOLLOW WARES



NEEDLE CASE
15-400
230 x 125 mm

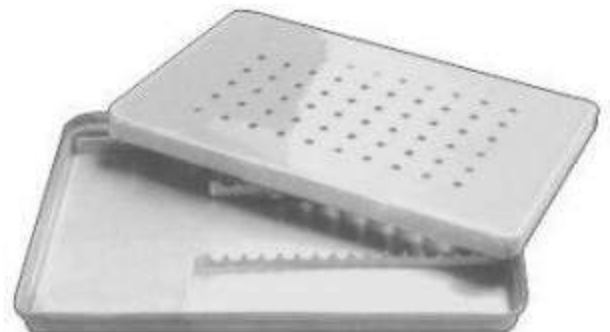

SCALER BOX
15-410
300 x 180 mm



SCALER TRAY
15-420
100 x 200 mm



Autoclaveable
15-430



INDO BOX WITH SILVER FRAME
15-440



INSTRUMENT TRAY WITHOUT COVER

	Size		Size
15-450	240 x 240 mm	15-461	230 x 125 mm
15-451	355 x 400 mm	15-462	200 x 150 mm
15-452	300 x 150 mm	15-463	250 x 200 mm
15-453	300 x 180 mm	15-464	300 x 250 mm
15-454	300 x 240 mm	15-465	350 x 300 mm
15-455	340 x 320 mm	15-466	400 x 350 mm
15-456	230 x 180 mm	15-467	450 x 300 mm
15-457	250 x 130 mm	15-468	300 x 200 mm
15-458	200 x 130 mm	15-469	350 x 250 mm
15-459	180 x 130 mm	15-470	250 x 125 mm
15-460	150 x 100 mm	15-471	200 x 100 mm
		15-472	400 x 200 mm



INSTRUMENT TRAY WITHOUT COVER

	Size		Size
15-480	240 x 240 mm	15-491	230 x 125 mm
15-481	355 x 400 mm	15-492	200 x 150 mm
15-482	300 x 150 mm	15-493	250 x 200 mm
15-483	300 x 180 mm	15-494	300 x 250 mm
15-484	300 x 240 mm	15-495	350 x 300 mm
15-485	340 x 320 mm	15-496	400 x 350 mm
15-486	230 x 180 mm	15-497	450 x 300 mm
15-487	250 x 130 mm	15-498	300 x 200 mm
15-488	200 x 130 mm	15-499	350 x 250 mm
15-489	180 x 130 mm	15-500	250 x 125 mm
15-490	150 x 100 mm	15-501	200 x 100 mm
		15-502	400 x 200 mm

HOLLOW WARES



KIDNEY TRAY WITH COVER
(English Pattern)

	Size
15-510	150 mm
15-511	200 mm
15-512	240 mm
15-513	300 mm



KIDNEY TRAY (German Pattern)
(without cover)

	Size
15-520	150 mm
15-521	200 mm
15-522	240 mm
15-523	300 mm



SPLIT LAMP
15-530
100 mL



BOWL

	Size
15-540	80 mm
15-541	100 mm
15-542	125 mm
15-543	150 mm
15-544	200 mm
15-545	250 mm
15-546	300 mm
15-547	350 mm
15-548	400 mm



WASH BASIN

	Size
15-560	80 mm
15-561	100 mm
15-562	125 mm
15-563	150 mm
15-564	200 mm
15-565	250 mm
15-566	300 mm
15-567	350 mm
15-568	400 mm



BOWL

	Size
15-580	80 mm
15-581	100 mm
15-582	125 mm
15-583	150 mm
15-584	200 mm
15-585	250 mm
15-586	300 mm
15-587	350 mm
15-588	400 mm



DRESSING JAR WITH KNOB

	Size
15-600	80 x 80 mm
15-601	100 x 100 mm
15-602	125 x 125 mm
15-603	150 x 150 mm
15-604	200 x 200 mm



DRESSING JAR

	Size
15-610	80 x 80 mm
15-611	100 x 100 mm
15-612	125 x 125 mm
15-613	150 x 150 mm
15-614	200 x 200 mm



DRESSING JAR

	Size
15-620	80 x 80 mm
15-621	100 x 100 mm
15-622	125 x 125 mm
15-623	150 x 150 mm
15-624	200 x 200 mm



DRESSING JAR

	Size
15-630	80 x 80 mm
15-631	100 x 100 mm
15-632	125 x 125 mm
15-633	150 x 150 mm
15-634	200 x 200 mm

HOLLOW WARES



**FORCEPS
JAR**

	Size
15-640	55 x 100 mm
15-641	55 x 140 mm
15-642	55 x 170 mm
15-643	55 x 180 mm
15-644	80 x 100 mm



**FORCEPS
JAR**

	Size
15-650	55 x 100 mm
15-651	55 x 140 mm
15-652	55 x 170 mm
15-653	55 x 180 mm
15-654	80 x 100 mm



**FORCEPS
JAR**

	Size
15-660	55 x 100 mm
15-661	55 x 140 mm
15-662	55 x 170 mm
15-663	55 x 180 mm
15-664	80 x 100 mm



**FORCEPS
JAR**

	Size
15-670	55 x 100 mm
15-671	55 x 140 mm
15-672	55 x 170 mm
15-673	55 x 180 mm
15-674	80 x 100 mm



**FORCEPS
JAR**

	Size
15-680	55 x 100 mm
15-681	55 x 140 mm
15-682	55 x 170 mm
15-683	55 x 180 mm
15-684	80 x 100 mm



COTTON HOLDER
15-690



GALIPOTS

	Capacity
15-700	2 Ounces
15-701	3 Ounces
15-702	4 Ounces
15-703	5 Ounces
15-704	6 Ounces
15-705	7 Ounces
15-706	8 Ounces



GALIPOTS

	Capacity
15-710	2 Ounces
15-711	3 Ounces
15-712	4 Ounces
15-713	5 Ounces
15-714	6 Ounces
15-715	7 Ounces
15-716	8 Ounces



SPRIT LAMP
15-720
100 ml.



INDO BOX ROUND
15-730

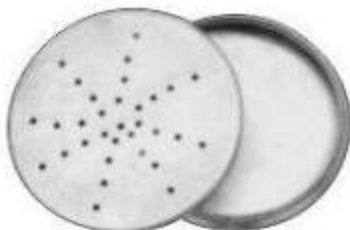

NEEDLE CASE
15-740



MEASURING JUG

	Capacity
15-750	1.00 Ltr
15-751	1.50 Ltr
15-752	2.00 Ltr



MEDICINE CUP GRADUATED

	Capacity
15-760	50 ml
15-761	60 ml
15-762	100 ml



BUCKET WITH LID

	Capacity
15-770	10 Ltr
15-771	12 Ltr
15-772	15 Ltr

HOLLOW WARES



SPUTUM MUG
15-780
100 x 50 mm



ENEMA CANE
Capacity
15-790 0.5 Ltr
15-791 1.5 Ltr
15-792 2.0 Ltr



DUST BIN
15-800
20 Lit



ROUND BADPAN
15-810
300 x 85 mm



BEDPAN
15-820
Size: Adult, Child



BEDPAN
15-830
Size: Adult, Child



FURNAL
15-840
100 mm



URINAL - FEMALE
15-850



URINAL - MALE
15-860



SHAVING MUG
15-870
100 mm

HOLLOW WARES

PERFORATED BASKETS

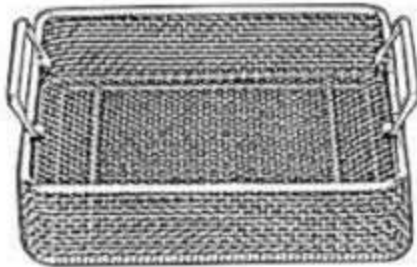

MESH BASKET

- 15-880 240 x 258 x 50 mm
- 15-881 250 x 240 x 100 mm
- 15-882 240 x 250 x 60mm

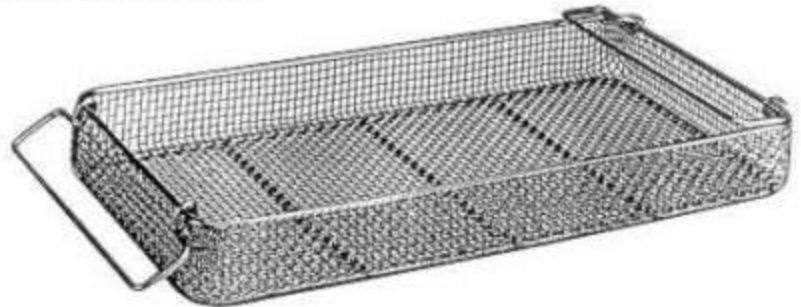

MESH BASKET

- 15-890 480 x 258 x 50 mm
- 15-891 480 x 258 x 100 mm
- 15-892 520 x 258 x 60mm
- 15-893 520 x 258 x 70mm
- 15-894 450 x 340 x 70mm
- 15-895 320 x 230 x 70mm

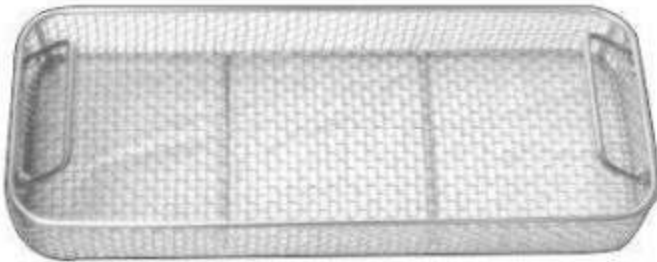

MESH BASKET

With Perforated Sheet Side

- 15-900 230 x 130 x 50 mm
- 15-901 230 x 130 x 60 mm
- 15-902 240 x 130 x 50 mm
- 15-903 240 x 130 x 60 mm
- 15-904 240 x 250 x 50 mm
- 15-905 240 x 250 x 60 mm
- 15-906 480 x 250 x 50 mm
- 15-907 480 x 250 x 60 mm
- 15-908 480 x 250 x 70 mm
- 15-909 300 x 300 x 50 mm
- 15-910 350 x 350 x 60 mm
- 15-911 470 x 400 x 60 mm
- 15-912 480 x 480 x 50 mm
- 15-913 480 x 480 x 60 mm
- 15-914 500 x 300 x 50 mm
- 15-915 520 x 300 x 50 mm
- 15-916 520 x 300 x 60 mm
- 15-917 550 x 430 x 50 mm
- 15-918 600 x 300 x 60 mm

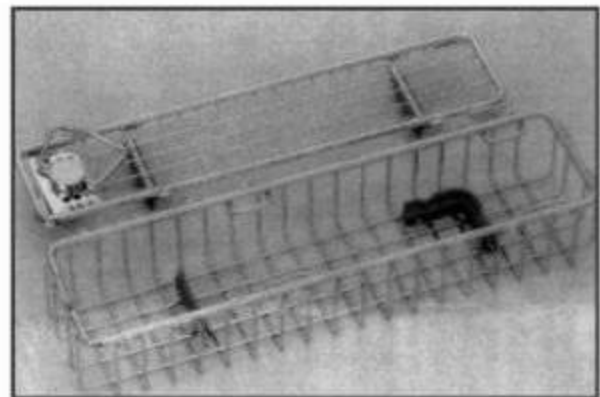

ARTHROSCOPE BASKET

- 15-930 290 x 80 x 52 mm

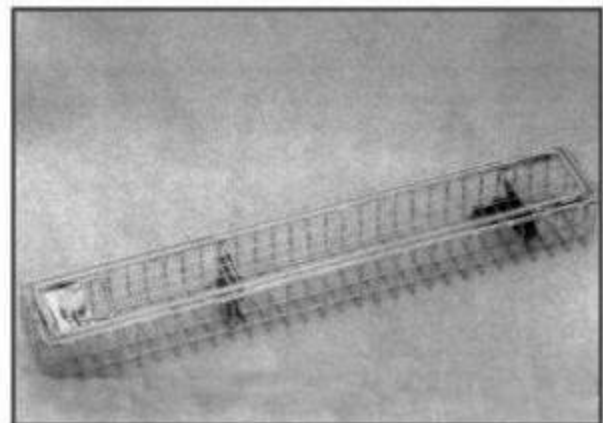

ENDOSCOPE BASKET

- 15-940 480 x 80 x 52 mm
- 15-941 660 x 80 x 52 mm
- 15-942 670 x 80 x 52 mm

STERILIZING FORCEPS



DAVIS
15-950 16 cm, 6 1/4"
15-951 20 cm, 8"
15-952 24 cm, 9 1/2"

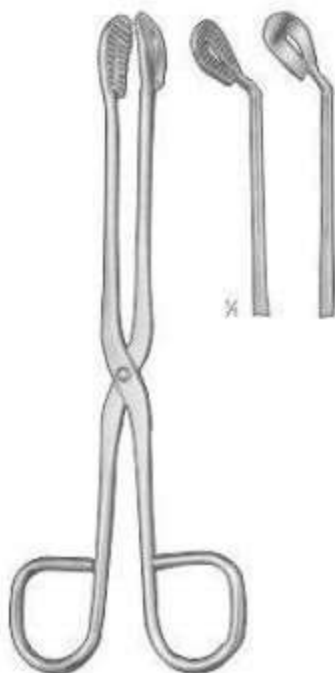

UTILITY
15-960 20 cm, 8"
15-961 28 cm, 11"



CHEATEL
15-970
28 cm

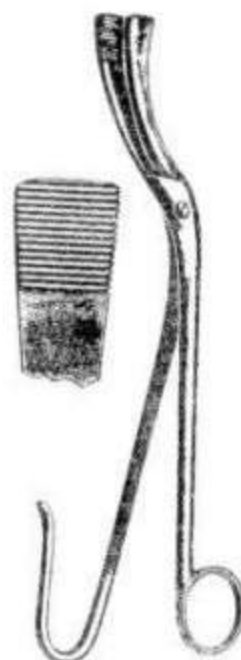

LONDON PATT
15-980
28 cm



HARRISON
15-990 25 cm
15-991 30 cm
15-992 36 cm
15-993 46 cm



15-1000 20 cm, 8"
15-1001 25 cm, 10"
15-1002 30 cm, 11 3/4"



ROGGE
15-1010
27 cm, 11"



CHEATEL
Box Joint
15-1020
27 cm, 11"

INDEX

DESCRIPTION	PAGE #	DESCRIPTION	PAGE #
A		Bergmann Scissors	27
Abadie Intestinal Forceps	152	Berliner Hammers	04
Abdominal Retractors	86	Bernhard Towel Forceps	50
Abdominal Trocars	05	Beyer Bone Rongeurs	120
Abraham Dissecting Knife	13	Beyer Rongeur	119
Acites Trocars	05	Bishop-Hrman Forceps	132
Adenoid Curettes	142	Blade Holder Blade Breaker	10
Adson / Micro-adson Dressing Forceps	36	Blake Gall Stone Forceps	155
Adson Bone Rongeurs	119	Blake Uterine Curettes	168
Adson Cardiovascular Forceps	95	Bialock Clamp	95
Adson Clip Applying Forceps	129	Blount Knee Retractor	113
Adson Dressing Forceps T.c.	39	Blumenthal Bone Rongeurs	118
Adson Elevator	111	Boerma Obstetrical Forceps	171
Adson Haemostatic Forceps	41	Böhler Bone Rongeurs	120
Adson Retractors	80	Bone Curettes	105, 106
Adson-Brown Tissue Forceps	36	Bone Curettes, Double-Ended	107
Alexander Chisel	110, 114	Bone Cutting Forceps	121, 122
Alexander Tenaculum Forceps	167	Bone Holding Forceps	100, 101, 102
Alligator Ear Forceps	136	Bone Hook	108
Allis Adair Intestinal Forceps	149	Bone Rongeurs	118, 199, 120
Allis Forceps	148	Bone Shear	97
Allis Intestinal Forceps	149	Bone Tamps	108
Amputation Knife	14-15	Bonney Dissecting Tissue Forceps T.c.	39
Amputation Saw	99	Bonney Tissue Forceps	35
Amputation, Resection & Dissecting Knives	15	Boucheron Ear Specula	133
Arruga Forceps	132	Bowl	178
Arruga Needle Holders T.c.	66	Bowles	03
Arruga Retractor	130	Bowman Lacrimal Probes	71
Arthroscope Basket	181	Bowman Retractor	130
Asch Septum Forceps	140	Box With Filter	176
Atraumatic Dressing, Cilia, Splinter Forceps	37	Bozemann Needle Holders T.c.	64
Aufranc Cobra Retractor	113	Bozemann Needle Holders	57
Autoclaveable	177	Brand Tunnelling Forceps	116
Auvard Vaginal Specula	161	Braun Decapitating Hook	173
Ayer Forceps	131	Braun Obstetrical Forceps	172
Ayre Dissecting Knife	13	Braun Tenaculum Forceps	166
		Braun Uterine Tenaculum Forceps	164
B		Braun-Stadler Scissors	27
Babcock Intestinal Forceps	150	Breisky Scale	173
Babcock Needle Holders T.c.	66	Breisky Wiener Modell/ Vienna Pattern	161
Babinsky Hammers	04	Brewster Retractor	78
Baby-Collin Retractors	85	Brodie Probe	72
Baby-Doyen Intestinal Forceps	151	Bronchus Cardiovascular Forceps	93
Baby-Mixer Haemostatic Forceps	46	Brophy Dressing Forceps	33
Baby-Mosquito (Hartmann) Haemostatic Forceps	40	Brophy Knives Forceps	147
Backhaus Clip Towel Forceps	50	Brophy Tissue Forceps	33
Backhaus Towel Forceps	49	Brown Tissue Forceps	36
Bacon Bone Rongeurs		Bruce-Clarke Needle Holders	57
Bailey-Baby Rib Spreader	95	Bruenings Septum Forceps	138
Bailey-Gibbon Rib Spreader	95	Bruenings Tongue Depressor	145
Bainbridge Haemostatic Forceps	44	Brunings Dissecting Knife	13
Bakes Gall Stone Forceps	155	Brunings Septatome Knives	140
Balfour Retractors	83	Brunner Rib Shears	98
Ball & Socket Towel Forceps	50	Bruns Bone Curettes	105-107
Ballenger Septum Gouge	141	Bruns Scissors T.c.	32
Ballenger Swivel Knife	140	Bruns Scissors	27
Ballenger Tonsil Forceps	147	Bryant Haemostatic Forceps	51
Bane Bone Rongeurs	119	Buchwald Tongue Depressor	145
Barnes-Neville Detachable Axis Traction Rod	172	Buck Curettes	140
Barraquer Needle Holders T.c.	66	Buck Hammers	04
Barraquer Scissors	25	Bucket With Lid	179
Barrett Uterine Tenaculum Forceps	164	Bulldog Clamp	89
Battery Handle	02	Byrd Suction Tubes	07
Beckmann Adenoid Curettes	142	C	
Beckmann-Adson Retractors	80	C.W. Mayo Abdominal Retractor	78
Beckmann-Eaton Retractors	80	Cairns Haemostatic Forceps	42
Bedpan	180	Carbould Tongue Forceps	146
Beebee Scissors	24	Cardinale Scissors	20
Bear Knife	130	Carmalt Splinter Forceps	38
Beeson Spreader	29	Carmalt Tongue Forceps	146
Beil-End	03	Carrel Haemostatic Forceps	40
Bennett Retractor	113	Carroll Tunnelling Forceps	116
Bergmann Mallets	104	Castroviejo Needle Holders	59
		Castroviejo Needle Holders T.c.	66

INDEX

DESCRIPTION	PAGE #	DESCRIPTION	PAGE #
Castroviejo Scissors	25	Czerny Retractors	76
Castroviejo		Czerny Tenaculum Forceps	166
Blade Breaker	10	D	
Castroviejo Forceps	131	Dahlgren Clip Applying Forceps	129
Cataract Knives	130	Dartigues Tenaculum Forceps	166
Cather Tray	176	Dartigus Retractors	77
Catheter Urethral	156	Dastoor Forceps	131
Catheters	156	Davidson Cardiovascular Forceps	95
Catlin Blade	14, 15	Davis Grasping Forceps	35
Catlin Dissecting Knife	15	Davis Sterilizing Forceps	182
Chandler Bone Elevator	111	Davis-Boyle Mouth Gag	144
Chaput Haemostatic Forceps	52	De Bakay / Lightweight Dressing Forceps	36
Chaput Intestinal Forceps	150	De Bakay Atraumatic Min Clamp	88
Charnley-Mueller Compression Clamp	117	De Bakay Cardiovascular Forceps	90, 92
Charriere Saw	99	De Bakay Dressing Forceps	36
Cheatei Sterilizing Forceps	182	De Bakay Scissors	22, 23
Cheron Dressing Forceps	53	De Lee Obstetrical Forceps	170
Cheyne General Instruments	70	De Vibiss Skull Cutting Forceps	129
Child Directors	157	Dean Scissors T.c	32
Child General Instruments	69	Dean-Shallcross Haemostatic Forceps	46
Citelli Rongeur	127	Deaver Retractors	73, 74
Clarke Retractor	130	Deaver Scissors	17
Cleveland Bone Cutting Forceps	121	Debakey Cardiovascular Forceps	91
Cleveland Bone Rongeurs	118	Debakey Clamp	89
Cleveland-Gardner Bone Cutting Forceps	121	Debakey Dressing Forceps	37
Cloward Retractors	81	Debakey Needle Holders T.c	62
Cloward Spreader	129	Debakey Scissors T.c	32
Clutton Urethral Bougies	157	De-Bakay Suction Tubes	06, 07
Coakley Sinus Curettes	134	Decker Intervertebral Disc Rongeur	125
Cobb Elevators	111	Dejerine Hammers	04
Colclough Rongeur	127	Denhardt Mouth Gag	143
Collier Needle Holders	56	Denis-Browne Retractors	86
Collin Blade	14, 15	Dennis-Brown Forceps	150
Collin Dressing Forceps	53	Derf Needle Holders T.c	61
Collin General Instruments	69	Derf Needle Holders	56
Collin Intestinal Forceps	150	Derra Cardiovascular Forceps	94
Collin Mallets	104	Deschamps Ligatur Needles	59
Collin Retractors	84, 85	Desjardins Gall Stone Forceps	155
Collin Rib Shear	97	Desjardins Haemostatic Forceps	45
Collin Scale	173	Desmarres Forceps	131
Collin Scalpel Handle	09	Desmarres Retractor	130
Collin Sponge Forceps	54	Dewey Obstetrical Forceps	171
Collin Tenaculum Forceps	166	Diagnostic Set	01
Collin Tongue Forceps	146	Diagnostic Sets & Catheter Introducing Forceps	01
Collin Uterine Sound	169	Diaphragm	03
Collin Vaginal Specula	159	Dieffenbach Clamp	89
Collin-Duval Grasping Forceps	35	Dieffenbach Dissecting Knife	11, 13
Collyer Scale	173	Diethrich Clamp	89
Colver Tonsil Forceps	147	Dilators Set	162
Cone Skull Puncher	129	Directors	157
Connell	03	Director General Instruments	70
Cooley Atraumatic Bulldog Clamp	88	Directors Probe	72
Cooley Cardiovascular Forceps	91	Dissecting & Vascular Scissors	21
Cooley Retractor	78	Dissecting Krts	08
Cooley Reverse Cut Scissors	21	Dissecting Knife	11, 12, 14
Cooley Suction Tubes	06	Dissecting Knives	13
Cooley-Baumgarten Wire Twister T.c	68	Dissecting Scissors	23
Corey (Greenhalg) Obstetrical Forceps	174	Doyen Intestinal Forceps	151
Cottle Mallets	104	Doyen Mallet	103
Cottle Scissors	23	Doyen Myoma Screw	169
Cottle-Kazanjan Bone Cutting Forceps	122	Doyen Probe	72
Cotton Carrier	154	Doyen Retractors	77, 85
Cotton Holder	179	Doyen Rib Raspatory	111
Coupland Suction Tubes	07	Doyen Rib Shears	98
Coxeter Urethral Catheters	156	Doyen Scissors	20
Crafoord Haemostatic Forceps	45	Doyen Towel Forceps	49
Crile Haemostatic Forceps	41	Doyen Vaginal Specula	160
Crile Needle Holders	59	Doyen-Collin Mouth Gag	143
Crile-Murray Needle Holders	56	Dressing & Tissue Forceps	33
Crile-Wood Needle Holders T.c	61, 62	Dressing Forceps	53
Crile-Wood Needle Holders	56	Dressing Jar With Knob	178
Critchett Retractor	130	Dressing Jar	178
Cusco Vaginal Specula	159	Duckbill Ear Forceps	136
Cushing Dressing Forceps	33		
Cushing Tissue Forceps	33		

INDEX

DESCRIPTION	PAGE #	DESCRIPTION	PAGE #
Duehrssen Dressing Forceps	35	Freer Hook	140
Duehrssen Tissue Forceps	35	Freer Mucous Knife	140
Duplayh Uterine Tenaculum Forceps	165	Freer Septum Chisel	141
Dupuy-Weiss Needle Forceps	147	Freer Septum Gouge	141
Dura Hooks / Nerve Hooks	124	Fricke Artery Forceps	51
Dura Twist Hook	124	Friedman & Mini-Friedman	118
Durham Retractors	76	Friedmann Vaginal Specula	161
Dust Bin	180	Fritsch Retractors	76
Duval Intestinal Forceps	150	Fuchs Forceps	132
Duval Needle Holders T.c.	68	Furmal	180
E		G	
Ear Polypus Forceps, Septum Forceps	135	Gabriel Intestinal Rectal Specula	153
Ear Specula	133	Galabin Uterine Sounds	163
Echlin / Stille-Luer Bone Rongeurs	119	Galipots	179
Echlin Bone Rongeurs	120	Gail Stone Forceps	155
Eicken-Killian Suction Tubes	141	Gauss Scalpel Flap Forceps	174
Elliot Obstetrical Forceps	170	Gellhorn Biopsy Punch Forceps	167
Elsching Forceps	132	Gellhorn Tenaculum Forceps	166
Emmet Dressing Forceps	53	Gelpi Vaginal Retractor	81
Endoscope Basket	181	Gelpi-Loktite Retractors	79
Enema Cane	180	General Instruments	69, 70, 71, 72
Engel Plaster Saw	29, 99	Gerald Dressing Forceps	33
Engl. Modell Towel Forceps	49	Gerald Tissue Forceps	33
Ent-Dean Scissors	22	Gerster Bone Holding Clamp	102
Enterotomy Scissors	23	Gerzog Mallets	104
Esmarch Scissors	27, 28	Giertz-Stille Rib Shears	98
Extraction Pliers T.c.	123	Gigli Handle	99
F		Gigli Saw	99
Face-Life, Dissecting, Nasal Scissors & Operating	19	Gillies Hook	148
Farabeuf Bone Holding Forceps	100	Gillies Needle Holders T.c.	65
Farabeuf Elevators	112	Gillies Needle Holders	58
Farabeuf Retractors	73	Gillies Nerve Hook	124
Farrell Applicators	70	Gillies Tissue Forceps	34, 36
Faure Tenaculum Forceps	166	Gillies-Mini Needle Holders T.c.	65
Favaloro Scissors	22	Gloves Box	176
Feilchenfeld Splinter Forceps	37	Gluck Rib Shear	97
Ferguson-Ackland Lip Retractors	143	Goldman-Fox Super Cut Scissors	26
Fergusson Bone Holding Forceps	100	Goodell Uterine Dilators Forceps	163
Fergusson Scissors	17	Gosset Retractors	82
Fergusson Suction Tubes	07	Graefe Forceps	132
Ferris - Smith Nasal Cutting Forceps	139	Graefe Retractor	130
Ferris - Smith Rongeurs	126	Graham Nerve Hook	124
Ferris-smith Tissue Forceps	34, 35	Graves Vaginal Specula	159
Fiber Handle Bone Curettes	107	Graves Vaginal Speculum Leep / Lietz	159
Finger Nail Drill	115	Gray Haemostatic Forceps	46
Finger Ring Cutter	29	Green-Armytage Obstetrical Forceps	174
Finocchietto Needle Holders	57	Gregory-Soft Clamp	89
Finocchietto Rib Retractors	96	Grey Turner Haemostatic Forceps	41
Finocchietto Haemostatic Forceps	45	Gross Dressing Forceps	53
Finocchietto Needle Holders T.c.	63	Gross Hook	134
Fischer Forceps	131	Gruber Aural Specula	133
Flat Nose Pliers & Wire Cutting Pliers T.c. Inserted	123	Gruenwald-Henke Nasal Cutting Forceps	138
Flat Nose Pliers	116	Guedel-Negus Set	02
Flat Nose Pliers, Tendon Tunnelling Forceps	116	Gum Scissors T.c.	32
Flat Nose, Combi-Flat, Vise Grip Pliers	117	Gum, Stitch & Wire Cutting Scissors	24
Flat Nosed Parallel Pliers	116, 117	Gumco Clamp	158
Flat Nosed Plier	117	Guy Tongue Holding Forceps	146
Fletcher Dressing Forceps	55	Guyon Haemostatic Forceps	46
Fleurant Trocars	05	Gynecological, Iris & Tendon Scissors	20
Foerster Sponge Forceps	54	H	
Foerster-Ballenger Sponge Forceps	54	Haemostatic Forceps, Tubing Clamps	48
Foman Rasp	108	Haig Ferguson Detachable Axis Traction Rod	171
Fomon Scissors	19	Hajek Mallets	104
Forceps Jar	179	Hajek-Kofler Rongeur	127
Ford	03	Hajek-Kofler Tonsil Punches	139
Ford-Bowles	03	Hakansson Bone Rongeurs	119
Foster-Gillies Needle Holders T.c.	65	Halsey Needle Holders T.c.	61
Fowler Dissecting Knife	13	Halstead Needle Holders	59
Francke	03	Halsted-Mosquito Haemostatic Forceps	40
Frazier Nerve Hook	124	Hank Uterine Dilators	162
Frazier Suction Tubes	07	Harrington Retractors	74
Freer Elevator	140, 141	Harrington Rochester Cardiovascular Forceps	94

INDEX

DESCRIPTION	PAGE #	DESCRIPTION	PAGE #
Harrison Sterilizing Forceps	182	Jeweler Type & Splinter Forceps	38
Hartmann Bone Rongeurs	118	Jobson-Horne General Instruments	70
Hartmann Ear Forceps	136	Johns-Hopkins Clamp	89
Hartmann Ear Specula	133	Jones / Perforating Towel Forceps	49
Hartmann Eustachian Catheters	134	Jorgenson Scissors	17
Hartmann Nasal Cutting Forceps	138	Joseph Adenoid Curettes	142
Hartmann Septum Forceps	135	Joseph Scissors	19
Hartmann Suction Tubes	141	Judd-Allis Intestinal Forceps	149
Hartmann-Hoffmann Ear Forceps	136		
Hartmann-Noyes Ear Forceps	136	K	
Hartmann-Wullstein Ear Forceps	136	Kalt Needle Holders	59
Head Frame	03	Kalt-Arruga Needle Holders	59
Heaney Haemostatic Forceps	47	Kane Obstetrical Forceps	174
Heaney Needle Holders T.c.	62	Kay Cardiovascular Forceps	93
Heath Mallets	104	Kaye Face-Lift Scissors	19
Heath Scissors	22	Kedamath Das Obstetrical Forceps	171
Hegar Needle Holders T.c.	64	Kelly Haemostatic Forceps	40
Hegar-Baumgartner Needle Holders T.c.	61	Kelly Intestinal Rectal Specula	153
Hegar-Vascular Needle Holders T.c.	64	Kelly Retractors	77, 78
Hegenbarth General Instruments	69	Kelly Scissors	19
Heiss Haemostatic Forceps	44	Kelly Scissors T.c.	32
Heister Mouth Gag	143, 144	Kelly Sponge Forceps	55
Hening Spreader	29	Kelly Tenaculum Forceps	166
Henley Retractors	80	Kern Bone Holding Forceps	101
Henrotin Uterine Tenaculum Forceps	165	Kerrison Tonsil Punches	139
Herbert Mallet	103	Key Periosteal Elevator	111
Hertzler Retractors	82	Kidney Tray With Cover	178
Hertzler Rib Retractors	96	Kielland Obstetrical Forceps	170
Hess Forceps	131, 132	Kielland-Luikart Obstetrical Forceps	170
Heymann Scissors	23	Killian Nasal Speculum	137
Heymann-Knight Septum Forceps	135	Killian Septum Gouge	141
Heywood Smith Dressing Forceps	55	Killian Suction Tubes	141
Heywood-Smith Obstetrical Forceps	174	Kilner Scissors	20
Heywood-Smith Sponge Forceps	54	Kilner Hook	148
Hibbs-Spratt Bone Curettes	105	Kilner Needle Holders T.c.	61
Hoen Periosteal Elevator	111	Kilner Needle Holders	57
Hohmann Elevator	114	Kilner Scissors	19
Hollow Wares	175	Kirschner Retractors	87
Holzbach Retractors	85	Kirschner Sleeves	117
Hooklets, Retractors	74	Kirschner-Balfour Retractors	87
Horrocks Uterine Sound	163	Kleinert-Kutz Bone Rongeurs	119
Horsley Bone Cutting Forceps	122	Knapp Forceps	131
Hudson Bone Drills	99	Knowles Scissors	28
Hunter Splinter Forceps	37	Knutson Urethrographie-Instruments	158
Hurd Tonsil Grasping Forceps	147	Kocher Haemostatic Forceps	43
Hydrocele Trocars	05	Kocher Intestinal Forceps	151
		Kocher Retractors	75, 76
I		Kocher Tonsil Grasping Forceps	148
Incision Scissors	17	Kocher-Atrauma Intestinal Forceps	151
Indo Box Round	179	Kocher-Ochsner Haemostatic Forceps	43
Indo Box With Silver Frame	177	Krause Trocars	05
Instrument Boiler Electric	176	Krause-Voss Nasal Polypus Snare	134
Instrument Boiler With Stand	176	Kristeller Vaginal Specula	160
Instrument Boiler	176	Kronlein Haemostatic Forceps	51
Instrument Tray With Cover	176	Kuehne Cilia Forceps	37
Instrument Tray Without Cover	177		
Instrument Tray	176	L	
Instruments Box	176	La Forceps Adenotomes	142
Iris Angular Scissors	20	Lahey (Sweet) Haemostatic Forceps	45
Iris Angular Super Cut Scissors	26	Lahey Clinic Nerve Hook	124
Iris Scissors T.c.	32	Lahey Tonsil Forceps	148
Iris Scissors	20	Lambotte Bone Holding Forceps	101
Iris Super Cut Scissors	26	Lambotte Chisel	110
		Lambotte Elevators	112
J		Lambotte Osteotomes	110
Jackson Vaginal Specula	160	Lamina Spreaders Forceps	129
Jaeger Knife	130	Laminectomy Punches	127
Jansen Bone Curettes	106	Laminectomy Rongeurs	125, 126
Jansen Retractors	79	Lambert Forceps	131
Jansen-Gruenwald Dressing Forceps	36	Landau Vaginal Specula	161
Jansen-Middleton Nasal Cutting Forceps	139	Lane Bone Holding Forceps	101
Jarvis Plier Forceps	154	Lane Intestinal Forceps	149, 150, 152
Jean Tissue Forceps	34	Lane Tissue Forceps	35
Jeweler Forceps	38	Lange-Hohmann Retractors	114

INDEX

DESCRIPTION	PAGE #	DESCRIPTION	PAGE #
Langenbeck	14	Martini Bone Curettes	106
Langenbeck Blade	15	Martini Needle Holders T.c.	64, 65
Langenbeck Bone Holding Forceps	100	Martin-Langenbeck Elevator	114
Langenbeck Dissecting Knife	15	Masson Needle Holders T.c.	63
Langenbeck Elevators	112, 114	Masson Needle Holders	58
Langenbeck Needle Holders	58	Mastin Tonsil Forceps	148
Langenbeck Polyous Forceps	154	Mathieu Forceps	158
Langenbeck Retractors	75, 76	Mathieu Intestinal Rectal Specula	163
Laryngoscope & Accessories	02	Mathieu Needle Holders T.c.	67
Le Grange Scissors	24	Mathieu Needle Holders	58
Lead Hand	116	Mathieu Tongue Holding Forceps	146
Lebsche Sternum Chisel	98	Matson Chisel	114
Legueu Retractors	85, 158	Maurer-Collin Rib Shears	98
Leksell Bone Rongeurs	120	Mayfield Bone Rongeurs	119, 120
Leksell-Stille Bone Rongeurs	119	Mayo Abdominal Retractor	78
Lempert Bone Rongeurs	119	Mayo Gall Stone Forceps	155
Lewin Bone Holding Forceps	102	Mayo Scissors	18
Lewkowitz Urethral Catheters Forceps	157	Mayo Scissors T.c.	30
Lexer Scissors T.c.	30	Mayo Super Cut Scissors	26
Lexer-Baby Scissors	19	Mayo-Blake Gall Stone Forceps	155
Lichtenberg Needle Holders T.c.	67	Mayo-Guyon Haemostatic Forceps	46
Lichtwitz Trocars	05	Mayo-Hegar Needle Holders T.c.	62
Lightweight	03	Mayo-Hegar Needle Holders	56
Lightweight-Adson Tissue Forceps	36	Mayo-Noble Scissors	18
Lister Bandage Scissors T.c.	32	Mayo-Russian Grasping Forceps	35
Lister Bandage Scissors	27, 28	Mayo-Stille Scissors	18
Lister Scissors	28	Mayo-Stille Scissors T.c.	30
Lister Sinus Forceps	51	Mc Indoe Bone Cutting Forceps	122
Lister Urethral Catheters	157	Mc Indoe Scissors	23
Lister-Excentric Scissors	28	Mc Lean-Tucker Obstetrical Forceps	171
Liston Blade	14, 15	Mcdonald Dissectors	70
Liston Bone Cutting Forceps	121	Mcindoe Dressing Forceps	34, 36
Liston-Key (Horsley) Bone Cutting Forceps	122	Mcintosh Set	02
Liston-Stille Bone Cutting Forceps	122	Mckenzie Clip Applying Forceps	129
Littauer / Liston Bone Cutting Forceps	121	Mclean Obstetrical Forceps	171
Littauer Scissors	24	Mead Bone Rongeurs	118
Littlewood Intestinal Forceps	149	Mead Mallet	103
Lockhart-Mummery Probe	72	Measuring Jug	179
Locking Pliers	117	Medicine Cup Graduated	179
Lockwood Intestinal Forceps	149	Mellinger Retractor	130
London Patt Sterilizing Forceps	182	Mesh Basket	181
Lopez-Reinke Suction Tubes	07	Metzenbaum Dissecting Scissors	18
Lorenz Scissors	28	Metzenbaum Needle Holders	57
Lorna Towel Forceps	50	Metzenbaum Nelson Scissors	18
Loute		Metzenbaum Scissors	18
Vise Grip	117	Metzenbaum-Baby Scissors	18
Love-Kerrison Laminectomy Puncher	128	Metzenbaum-Jamison Scissors	18
Lovelace Cardiovascular Forceps	94	Meyerdig Retractors	75, 77
Lowa Uterine Tenaculum Forceps	164	Michel General Instruments	69
Lower Haemostatic Forceps	45	Micro Alligator Forceps	125, 126
Lowman-Hoglund Bone Holding Clamp	102	Micro Grasping Forceps	125
Lowmann Bone Holding Clamp	102	Micro Scissors	25
Lubet-Barbon Septum Forceps	135	Micro-Halsted Haemostatic Forceps	40
Luc Septum Forceps	138	Microvascular Needle Holders T.c.	65
Lucae / Ent Dressing Forceps	35	Mikulicz Haemostatic Forceps	48
Lucae Ear Forceps	135	Mikulicz Intestinal Forceps	151
Lucae Mallet	103	Mikulicz Retractors	77
Luer Bone Rongeurs	118	Miller Alveotomy File	108
Luikart Obstetrical Forceps	172	Miller-Colburn Bone File	108
Lumbar Lamina Spreader	129	Milligan Retractors	79
Lure Polyous Forceps	154	Millin Forceps	158
Lynch Tonsil Knives Forceps	147	Millin Retractors	158
		Millin's Suction Tube	06
		Milne Murray Detach-Able Axis Traction Rod	172
		Mini Lambotte Osteotomes	110
		Mini-Lambotte Chisel	110
		Miroo Cup Forceps	125
		Miskimon Retractors	80
		Mixer Haemostatic Forceps	45
		Mixer Scissors	17
		Mixer-O'Shaugnessy Haemostatic Forceps	45
		Model Usa Combi-Flat Pliers	117
		Model Usa Dressing Forceps	36
		Model Usa Tissue Forceps	36
		Modified-Usa Scissors	24
M			
M.G. Hospital Needle Holders	56		
Macphail Needle Holders	59		
Magill Forceps	01		
Malleolar Bone Holding Forceps	102		
Mallet	103		
Mallets	104		
Merkwalder Bone Cutting Forceps	121		
Marquardt Bone Rongeurs	120		
Martel Haemostatic Forceps	52		
Martin Uterine Sounds	163		

INDEX

DESCRIPTION	PAGE #	DESCRIPTION	PAGE #
Molt Mouth Gag	143	Perthes Bone Awtls	108
Morris Retractors	76	Phaneuf Haemostatic Forceps	46
Mouth Gag, Lip Retractors	143	Pinard Stethoscopes	03
Moyrihan Haemostatic Forceps	47	Piper Obstetrical Forceps	170, 171
M-Pelvimeter Scale	173	Pituitary Rongeur	126
Mueller Retractor	130	Plaster Scissors	27, 28
Murless Obstetrical Forceps	174	Plaster Shears	29
Museux Uterine Tenaculum Forceps	165	Plaster Spatula General Instruments	70
N		Plaster Retractors	81
Nabatoff Varicose Vein Probe Set	88	Ploitzer Ear Specula	133
Naegele Obstetrical Forceps	170, 173	Politzer Tympanum Needle	134
Nail Extracting Forceps	115	Pool Suction Tubes	06
Nail Splitting Forceps	115	Poots-Smith Dressing Forceps	33
Nasal Speculum	137	Post Morten Saw	99
Nasal Suction Tubes	07	Potts Tenotomy Scissors	21
Nasal Tompon, Curettes, Tympanum Needle	134	Potts-Reynolds Tenotomy Scissors	21
Nauton-Morgan Intestinal Rectal Specula	153	Potts-Smith Dressing Forceps T.c.	39
Needle Case	177, 179	Potts-Smith Scissors	22
Needle Holders & Ligatur Needles	59	Potts-Smith Tissue Forceps	33
Needle Nose Pliers	116	Pozzi Uterine Tenaculum Forceps	164
Negus Haemostatic Forceps	47	Pratt Gyne Uterine Dilators	162
Nelaton Probe	72	Pratt Haemostatic Forceps	52
Nelson Trocars	05	Pratt Uterine Tenaculum Forceps	165
Nerve Separator & Spatula	124	Presbyterian Tubing Clamps	48
Neuro-Duoflex Hammers	04	Price-Thomas Cardiovascular Forceps	94
Nge Spreader	129	Probes General Instruments	70
Non-Perforating Towel Forceps	49	Providence-Hospital Haemostatic Forceps	40
Noto Sponge Forceps	55	Pruesmann Tenaculum Forceps	166
Noto Tenaculum Forceps	166	Punches	128
Novak Suction Cannula Curette	163	Putti Rasp	108
Novak Uterine Curettes	169	Q	
Noyes Scissors	25	Quinby Scissors	23
Nussbaum Intestinal Forceps	151	Quire Ear Polypus Forceps	135
O		R	
O'Sullivan O'Connor Retractors	84	Rabiner Hammers	04
Ochsner Trocars	05	Ralk Splinter Forceps	38
Oldberg Rongeur	127	Ramplsey Sponge Forceps	54
Olivecrona Dissecting Knife	13	Ramsay Tissue Forceps	34
Olivecrona Scissors	23	Randall Urethral Catheters	156
Olsen Needle Holders	58	Randall Uterine Curettes	169
Olsen-Hegar Needle Holders T.c.	64	Raney Clip Applying Forceps	129
Ombredanne Mallets	104	Rankin Haemostatic Forceps	41
Operating & Dissecting Scissors	18	Ratchet Fixation Bone Holding Forceps	102
Operating Scissors T/c Inserted	30	Rayder Needle Holders T.c.	63
Operating, Dissecting Scissors	17	Razor	14
Ortho Bone Holding Forceps	102	Reamer, Elevators, Bone Files & Alveotomy Files	108
Ortho Mallets	104	Recamier Uterine Curettes	168
Orthopaedic Mallet	104	Reduction Bone Holding Forceps	101, 102
Osteotomes, Gouges	109, 110	Reil Bone Holding Forceps	101
Otoscope Set	01	Reiner Knife	29
Overholt-Geissendoerfer Haemostatic Forceps	44	Reiner Tip	134
P		Reposition Bone Holding Forceps	102
Parker Retractors	73	Resection Knife	14, 15
Partsch Chisel	109	Retractor For Knee	114
Partsch Mallet	103	Reverdin Needles	60
Patella Bone Holding Forceps	102	Reynolds Scissors	19
Payr Intestinal Forceps	152	Rib Retractors	96
Payr-Baby Intestinal Forceps	152	Rib Shear	97
Pean Haemostatic Forceps	42, 51	Rib Shears, Sternum Chisel	97, 98
Pederson Vaginal Specula	159	Ricard Retractors	85
Pederson Vaginal Speculum Leep / Lietz	159	Richardson Retractors	76
Peers-Bertman Towel Forceps	50	Richardson-Eastman Retractors	76
Peet Splinter Forceps	38	Richter Scissors	17
Pennington / Siezing Haemostatic Forceps	52	Richter-Heath General Instruments	69
Percussion Hammers	04	Ring Cutter	115
Percy Intestinal Forceps	150	Roberts Haemostatic Forceps	46
Percy Retractor	99	Rochard Retractors	85
Perforated Baskets	181	Rochester-Carmalt Haemostatic Forceps	44
Perforated Box	176	Rochester-Mayo Needle Holders	59
Perforated Tray	176	Rochester-Ochsner Haemostatic Forceps	43
Periosteal Elevators	111, 112, 113	Rochester-Pean Haemostatic Forceps	43
		Roeder Towel Forceps	49

INDEX

DESCRIPTION	PAGE #	DESCRIPTION	PAGE #
Rogge Sterilizing Forceps	182	Semken Tissue Forceps	33
Rosen Specula	133	Semm Retractors	86
Roser-konig Mouth Gag	143	Senn-Mueller Retractors	75
Round Badpan	180	Septum Chisels, Septum Gouges	141
Round Cut Scissors	24	Septum Forceps, Septum Knives, Curettes	140
Roux Retractors	73	Septum Forceps, Tonsil Punches	138, 139
Rubio Wire Twister T.c.	68	Sequestrum Bone Holding Forceps	100
Rumel Haemostatic Forceps	44	Seutin Scissors	28
Ruskin Bone Rongeurs	119	Shaving Mug	180
Ruskin Bone Splitting Forceps	122	Siegle Ear Set	133
Ruskin Rongeur	120	Simon Bone Curettes	106
Ruskin-Liston Bone Cutting Forceps	121	Simon Dissecting Knife	13
Ruskin-Mini Bone Rongeurs	119	Simpson Obstetrical Forceps	170
Russian-Modell Grasping Forceps	35	Simpson-Braun Obstetrical Forceps	170
Ryder-Vascular Needle Holders T.c.	63	Simpson-Luikart Obstetrical Forceps	171
S		Sims Intestinal Rectal Specula	153
Sachs Nerve Hook	124	Sims Scissors	20
Saenger Obstetrical Forceps	174	Sims Uterine Curette	163, 168, 169
Sakuras Vaginal Specula	159	Sims Uterine Dilators Forceps	163
Sarot Cardiovascular Forceps	93	Sims Uterine Sounds	163
Sarot Needle Holders T.c.	62	Sims Vaginal Specula	160
Sarot Needle Holders	58	Sims-Kelly Retractor	78
Satinsky Cardiovascular Forceps	93	Sims-Kelly Vaginal Specula	160
Satterlee Saw	99	Sims-Maier Dressing Forceps	53
Sauerbruch Bone Rongeurs	120	Skene Uterine Tenaculum Forceps	165
Sauerbruch Retractors	77	Slayer Scissors	21
Sauerbruch Sternum Shears	97	Slip Joint Vise Grip Pliers	117
Sauerbruch-Frey Sternum Shears	97	Smellie Decapitating Hook	173
Scaler Box	177	Smellie Obstetrical Forceps	173
Scaler Tray	177	Smith (Mod. Usa) Scissors	27
Scalpel Handle #3	09	Smith Peterson Chisel	109
Scalpel Handle #3 / Long Angled	09	Smith Retractor	130
Scalpel Handle #3 Graduated	09	Snellen Forceps	131
Scalpel Handle #3, #4	09	Somer Tenaculum Forceps	166
Scalpel Handle #4	09	Spare Rubber	03
Scalpel Handle #7	09	Spencer / Delicate Scissors	24
Scalpel Handle 3l Long	09	Spencer-Wellis Haemostatic Forceps	42
Scalpel Handle 4l	09	Sponge & Dressing Forceps	55
Scalpel Handle 4l Long	09	Sponge Forceps	54
Scalpel Handles	09, 10	Sprague-Bowles	03
Scalpel Plastic Handle	09	Spratt Bone Curettes	105, 107
Scalpel Plastic Handle # 5	09	Spreader	29
Scalpel Plastic Handle # 6	09	Sprit Lamp	179
Schaedel Towel Forceps	49	Spurling-Love Rongeur	127
Scherback Vaginal Specula	161	Sputum Mug	180
Schimmelbusch	03	St. Clair-Thomson Adenoid Curettes	142
Schmeden Nasal Cutting Forceps	138	Standard Dressing Forceps T.c.	39
Schmidt-Rimplex Forceps	132	Standard Dressing Forceps	33
Schnidt / Sawtell Tonsil Forceps	147	Standard Operating Scissors	16
Schoemaker Tonsil Forceps	148	Standard Scissors T.c.	30
Schoemaker-Loth Scissors	24	Standard Super Cut Scissors	26
Schröder Gyne Uterine Tenaculum Forceps	164	Standard Tissue Forceps T.c.	39
Schröder Uterine Tenaculum Forceps	164	Standard Tissue Forceps	33
Schroeder Uterine Tenaculum Forceps	164, 165	Staude-Moore Uterine Tenaculum Forceps	164
Schuardt Sternum Shears	97	St-Clair Thomson Nasal Speculum	137
Schubert Tenaculum Forceps	167	Stellbrink Synovectomy Rongeur	118
Schumacher Sternum Shears	97	Sterilizing Drums	175
Schumacher Tenaculum Forceps	167	Sterilizing Forceps	182
Scoville Bone Curettes	107	Sternum Wire Twister T.c.	68
Scoville Nerve Hook	124	Stethoscopes	03
Scoville-Richter Retractors	84	Stevens Needle Holders	59
Screw Nut Wrench	117	Stevens Tenotomy Super Cut Scissors	26
Scudder Intestinal Forceps	151	Stieglitz Splinter Forceps	37, 38
Segond Dissecting Knife	13	Stille Bone Rongeurs	120
Segond Myoma Knife	169	Stille Chisel	109
Sellheim Obstetrical Forceps	174	Stille Haemostatic Forceps	46
Sellors Rib Contractor	95	Stille Intestinal Forceps	149
Semb Bone Cutting Forceps	122	Stille Plaster Shears	29
Semb Bone Holding Forceps	100	Stille Rongeur Forceps	120
Semb Bone Rongeurs	120	Stille Tissue Forceps	34
Semb Elevator	115	Stille-Listo Bone Cutting Forceps	121
Semb Vascular Clamps	98	Stille-Luer Bone Rongeurs	119
Semken Dressing Forceps	33	Stille-Luer Rongeur Forceps	120
		Stille-Ruskin Bone Rongeurs	119
		Stone Urethral Catheters	157

INDEX

DESCRIPTION	PAGE #	DESCRIPTION	PAGE #
Strabismus Forceps	131	Virchow Amputation Knife	15
Strabismus Scissors	20	Volkman Bone Curettes	105
Stratton Needle Holders T.c	64	Volkman Bone Curettes	107
Strully Scissors	22	Voltoini (duplay) Nasal Speculum	137
Strümpel Ear Forceps	136	W	
Struycken Nasal Cutting Forceps	138	Wachenfeldt General Instruments	69
Subramanian Cardiovascular Forceps	93	Waib Amputation Knife	15
Suction Tubes	06, 07	Walsham Septum Forceps	140
Super Cut Scissors	26	Walton-Iiston Bone Cutting Forceps	121
Syme Needles	70	Wangensteen Cardiovascular Forceps	94
T		Wangensteen Dressing Forceps	33
Takahashi Nasal Cutting Forceps	138	Wangensteen Needle Holders T.c	63
Target Decapitating Hook	173	Wangensteen Needle Holders	57
Tarnier Obstetrical Forceps	171, 172	Wangensteen Tissue Forceps T.c	39
Taylor Hammers	04	Wartenberg Hammers	04
Taylor Tissue Forceps	34	Wash Basin	178
Teale Uterine Tenaculum Forceps	164	Watson-Williams Nasal Cutting Forceps	138
Tendon Tunnelling Forceps	116	Weber Cardiovascular Forceps	92
Tenotomy Scissors	21	Webster Needle Holders T.c	61
Tenotomy-Stevens Scissors	21	Webster Needle Holders T.c	62
Thomas Uterine Curettes	169	Webster Needle Holders	56
Thoms-Gaylor Tenaculum Forceps	167	Wecker Forceps	131
Thomson Walker Needle Holders	57	Weider Tongue Depressor	145
Thorek Scissors	18	Weider Tonsil Grasping Forceps	147
Thudichum (Goldsmith) Nasal Speculum	137	Weil - Blakesley Laminectomy Rongeurs	125
Tissue & Dressing Forceps T.c	39	Weingartner Ear Forceps	136
Tissue & Dressing Forceps	34, 35, 36	Weitlaner Retractors	79
Tivnen Tonsil Seizing Forceps	147	Wertheim Haemostatic Forceps	47
Tobold Tongue Depressor	145	Wertheim-cullen Haemostatic Forceps	47
Toennis Needle Holders T.c	67	Westcott Scissors	25
Toennis Nerve Hook	124	Wheelhouse Urethral Catheters	157
Tohoku Towel Forceps	50	White Tonsil Forceps	147
Tongue Depressor	145	Whitehead Mouth Gag	144
Towel Forceps	49, 50	Whitehead-Jennings Mouth Gag	144
Traube Hammers	04	Wilde Intervertebral Disc Rongeur	125
Treves Tissue Forceps	34	Wilde Nasal Polypus Snare	134
Trocars	05	Willet-Martel Haemostatic Forceps	52
Troeltsch Ear Forceps	135	Willet Scalpel Flap Forceps	174
Troemner Hammers	04	William Lacrimal Probes	71
Troemner-Simplex Hammers	04	Williger Bone Curettes	105
Troutman-Chris Blade Breaker	10	Williger Bone Curettes	106
Tubing Clamps	48	Williger Elevator	114
Tuffier Haemostatic Forceps	52	Williger Mallet	103
Tuffier Rib Retractors	96	Winkelmann Circumcision Clamps	158
Tumarkin Specula	133	Winter Obstetrical Forceps	174
U		Winterton Vaginal Specula	159
Uffenorde Bone Curettes	106	Wire & Clothing Scissors	28
Ulrich Sponge Forceps	55	Wire Cutters T.c	123
Universal Bandage Scissors	27	Wire Cutting T.c	32
Universal Bone Rongeurs	118	Wire Tightening Pliers T.c	68
Universal Scissors	24	Wire Twisters Needle Holders T.c	68
Universal Scissors T.c	123	Wolff Cast Breaker	29
Universal Trocars	05	Worth Forceps	131
Unna Tonsil Grasping Forceps	148	Wright Needle Holders	57
Urinal - Female	180	Wrigley Obstetrical Forceps	170
Urinal - Male	180	Wylie Uterine Dilators Forceps	163
Us-Army Retractors	73	Y	
Uterine Dilators	162	Yankauer Inhalers	03
Uterine Tenaculum Forceps	164, 165	Yankauer Nasal Speculum	137
Utility Sterilizing Forceps	182	Yankauer Suction Tubes	06
V		Yasargil-Sami Tissue Forceps	35
Valleix Uterine Sounds	163, 169	Yeomann Biopsy Punching Forceps	154
Van Buren Bone Holding Forceps	100	Young Boomrang Reverdin Needles	60
Van Doren Tenaculum Forceps	167	Young Tongue Holding Forceps	146
Vascular Scissors	22	Young Urethral Forceps	157
Vascular, Dissecting & Plaster Scissors T/c Inserted	32	Z	
Vascular, Enterotomy & Tonsil Scissors	23	Zaikind Lung Retractor	78
Verbrugge Bone Holding Forceps	101	Zaufal-Jansen Bone Rongeurs	120
Vickers Mallet	103	Zollner Ear Specula	133
Vienna Nasal Speculum	137	Zweifel Needle Holders T.c	67
		Zweifel Uterine Curettes	168



Address: P.O. Box 1146 Sialkot Pakistan.

Phone: +92 52 3258375

Fax: +92 52 3258376

Email: info@hydeoutent.com

Web: www.hydeoutent.com

